



**Ermis**<sup>®</sup>  
MedTech



**CHIRURGISCHE INSTRUMENTE**  
**SURGICAL INSTRUMENTS**

Im Herzen des Weltzentrums der Medizintechnik, als Nachfolger der Firma Ermis Medizintechnik e.K., versorgen wir seit 1998 unsere Kunden weltweit mit qualitativ hochwertigen Gütern für die ZSVA.

Dabei bedienen wir sowohl die Marktsegmente für wiederverwendbare Produkte, als auch für Einmalprodukte.

Als erfahrener Hersteller bieten wir eine breite Palette hochwertiger und maßgeschneiderter Produkte für die Krankenhäuser und Kliniken weltweit von individuell gestalteten Artikeln, über kundenspezifische Sets bis hin zu komplexen Baugruppen.

Die stetige Weiterentwicklung und enge Kooperation mit unseren Anwendern führt fortführend zu einer Erweiterung unseres Produktsortiments und unserem Know-How in der Medizintechnik.



From the world center of the Medical Technology as the successor of Ermis Medizintechnik e.K., we supply our customers worldwide since 1998 with high quality products for the CSSD. Thereby, we manage on both market segments for the reusable products and for single use products. As an experienced supplier we offer a wide range of high quality as well as customized products for the hospitals worldwide, individually designed items, from customized sets through to complex elements. The continuous development and close co-operation with our users lead each time to extension of our product line and our know-How in the medical technology.

**Aktuelle Zertifikate und AGB finden Sie auf unserer Internetseite:**  
[www.ermis-medizintechnik.de](http://www.ermis-medizintechnik.de)

You find our current Certificates and General Terms and Conditions on our website:  
[www.ermis-medizintechnik.de](http://www.ermis-medizintechnik.de)



Seite  
Page

**02**                    **Einleitung /** Introduction

---

**03**                    **Inhaltverzeichnis /** Index

---

**04 - 09**            **Skalpelle und Messer /** Scalpels and Knives

---

**10 - 70**            **Scheren /** Scissors

---

**71 - 104**          **Pinzetten /** Forceps

---

**105 - 146**        **Klemmen /** Clamps

---

**147 - 194**        **Retraktoren /** Retractors

---

**195 - 204**        **Trokare, Saug- und Spülinstrumente, Sonden, Watteträger /**  
Trocars, Suction and Irrigation Instruments, Probes, Cotton Applicators

---

**205 - 234**        **Wundverschluß /** Woundclosure

---

**235 - 262**        **Abdominale Chirurgie /** Abdominal Surgery

---

**263 - 304**        **Gynäkologie und Geburtshilfe /** Gynecology and Obstetrics

---

**305 - 371**        **Knochenchirurgie /** Bone Surgery

---

**372 - 376**        **Hygiene und Aufbewahrung /** Hygiene and Storage

---

**377 - 390**        **Alphabetisches Inhaltsverzeichnis /** Alphabetical Index

---

**Bei den angebotenen Produkten kann es sich um ERMIS eigene Ware  
wie auch um Handelsware handeln.**

The offered products can be concerned as Ermis's own product as well as trading products.

**Unsere Produkte werden den regulatorischen Anforderungen entsprechend gekennzeichnet.**  
Our products will be marked according to the International Regulatory Requirements.

**Unsere Lieferungen und Leistungen richten sich an Unternehmer im Sinne des § 14 BGB,  
nicht an Endverbraucher im Sinne § 13 BGB.**  
Our deliveries and services are directed at entrepreneurs within the meaning of § 14 BGB (German Civil Code),  
not at end consumers within the meaning of § 13 BGB.



## Skalpelle und Messer *Scalpels and Knives*



**Skalpelle / Scalpels**  
**Rasierklingen, Rasierklingenbrecher und -halter /**  
*Razor Blades, Razor Blade Breaker and -Holder*  
**Anatomische Skalpelle / Dissecting Knives**  
**Amputationsmesser / Amputation Knives**  
**Resektions- und Seziermesser / Resection- and Autopsy Knives**  
**Dermatome / Dermatomes**





Fig. 64

ER 01070-64

Fig. 67

ER 01070-67

Fig. 69

ER 01070-69

steril, Verpackungseinheit à 10 Klingen  
sterile, Packing unit 10 blades



13,5 cm - 5¼"  
ER 01071-13



15,5 cm - 6"  
ER 01071-15



No. 3  
12,5 cm - 5"  
ER 4850-03



No. 3  
12,5 cm - 5"  
ER 4850-13



No. 3  
21 cm - 8¼"  
ER 4850-17



No. 3 L  
21 cm - 8¼"  
ER 4850-31



No. 3+4  
16 cm - 6¼"  
ER 4850-10



No. 4  
13,5 cm - 5¼"  
ER 4850-04



No. 4 L  
21 cm - 8¼"  
ER 4850-41



No. 7  
16 cm - 6¼"  
ER 4850-07



Griffdurchmesser  
Handle diameter  
Ø 5,5 mm



TROUTMAN-CHRIS

9 cm - 3½"  
ER 4876-09

Rasierklingen,  
Verpackungseinheit  
à 10 Klingen  
Razor Blades,  
Packing unit  
10 blades



ER 4874-00

Rasierklingenhalter,  
mit Riegelschloss  
Razor blade holder,  
with slide catch



CASTROVIEJO

Griffdurchmesser  
Handle diameter  
Ø 8 mm



gerade  
straight

12,5 cm - 5"  
ER 4878-13

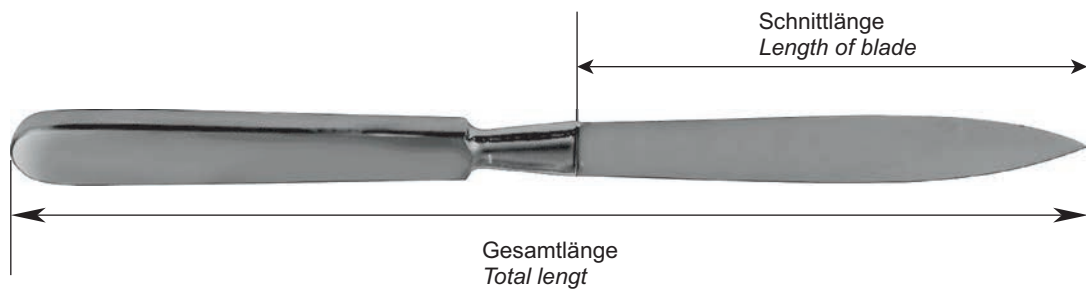

**LISTON**

| Gesamtlänge<br>Total length | Schnittlänge<br>Length of blade |            |
|-----------------------------|---------------------------------|------------|
| 26 cm – 10¼"                | 13 cm – 5"                      | ER 4880-13 |
| 29 cm – 11½"                | 16 cm – 6¼"                     | ER 4880-16 |
| 32 cm – 12½"                | 19 cm – 7½"                     | ER 4880-19 |
| 35 cm – 13¾"                | 22 cm – 8¾"                     | ER 4880-22 |



**LISTON**

| Gesamtlänge<br>Total length | Schnittlänge<br>Length of blade |            |
|-----------------------------|---------------------------------|------------|
| 31 cm – 12¼"                | 17 cm – 6¾"                     | ER 4881-17 |
| 34 cm – 13½"                | 20 cm – 8"                      | ER 4881-20 |



## Resektions- und Seziermesser Resectio- and Autopsy Knives

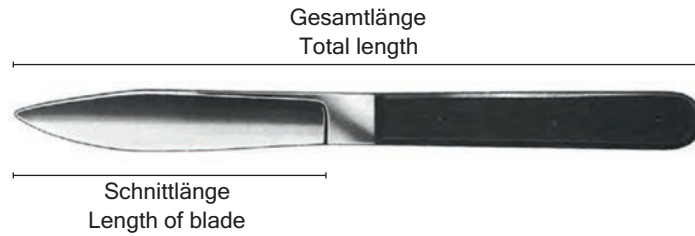

Resektionsmesser  
Resection knife

| Gesamtlänge<br>Total length | Schnittlänge<br>Length of blade |            |
|-----------------------------|---------------------------------|------------|
| 18 cm – 7"                  | 5,5 cm – 2¼"                    | ER 4888-05 |

LANGENBECK



Seziernmesser  
Autopsy knife

| Gesamtlänge<br>Total length | Schnittlänge<br>Length of blade |            |
|-----------------------------|---------------------------------|------------|
| 27 cm – 10½"                | 12 cm – 4¾"                     | ER 4892-11 |

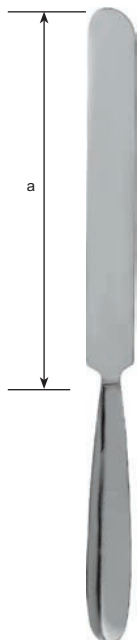

VIRCHOW

| A            |  |            |
|--------------|--|------------|
| 16,0 cm, 6¼" |  | ER 4890-16 |
| 20,0 cm, 8"  |  | ER 4890-20 |
| 24,0 cm, 9½" |  | ER 4890-24 |





Dermatom SCHINK, einstellbar von 0,1 mm - 2,0 mm,  
komplett mit 1 x auswechselbarer Klinge und  
2 Spannplatten

Dermatome SCHINK, adjustable from 0.1 mm - 2.0 mm,  
complete with 1 interchangeable blade and  
2 straightening plates



SCHINK

30 cm - 11¾"  
ER 4899-00

Ersatzklinge, allein  
Spare blade, only

ER 4899-01



Spannplatte, allein  
Skin straightening plate, only

ER 4899-02



Ersatzklinge, allein  
Spare blade, only

ER 4899-10

19 cm - 7½"  
SILVER ER 4899-03



## Scheren Scissors

**Mikro Federscheren / Micro Spring Scissors**

**Feine Scheren / Delicate Scissors**

**Feine Chirurgische Scheren / Delicate Surgical Scissors**

**Chirurgische Scheren / Surgical Scissors**

**Feine Präparierscheren / Delicate Dissecting Scissors**

**Enukleationsscheren / Enucleation Scissors**

**Präparierscheren / Dissecting Scissors**

**Facelift- und Nasenscheren / Face Lift and Nasal Scissors**

**Nasenscheren / Nasal Scissors**

**Gefäßscheren / Vascular Scissors**

**Neurochirurgische Scheren / Neurosurgical Scissors**

**Tonsillen-Scheren / Tonsil Scissors**

**Darmscheren / Enterotomy Scissors**

**Ligaturscheren / Ligature Scissors**

**Gynäkologische Scheren / Gynecological Scissors**

**Nabelschnurscheren / Umbilical Scissors**

**Damm-(Episiotomie-) Scheren / Perineum (Episiotomy) Scissors**

**Parametriumscheren / Parametrium Scissors**

**Kronenscheren / Crown Scissors**

**Zahnleischscheren / Gum Scissors**

**Nagelscheren / Nail Scissors**

**Draht-, Blechscheren / Wire, Metal Cutting Scissors**

**Verbandscheren / Bandage Scissors**

**Gipsscheren / Plaster Shears**

**Knochenscheren / Bone Scissors**

**Rippenscheren / Rib Shears**





#### Standard-Schere

- aus hochwertigem Edelstahl

#### Standard Scissors

- made of stainless steel



ER 1311-14

#### SuperCut-Schere (MC)

- untere Schneide mit einem Rasierklingschliff
- obere Schneide mit einer Mikroverzahnung
- Ringe mit Schwarzbeschichtung
- die Artikelnummer endet mit dem Buchstaben / **M**

#### SuperCut Scissors (MC)

- lower blade with razor-sharp cut
- upper blade with micro serrated cut
- black plated rings
- the article number ends with the letter / **M**



ER 1311-14**M**

#### Schere mit Keramikbeschichtung (CC)

- schwarze Keramikbeschichtung
- vergoldete Schraube
- die Artikelnummer endet mit dem Buchstaben / **C**

#### Scissors with Ceramic Coating (CC)

- black ceramic coating
- gold plated rings
- the article number ends with the letter / **C**



ER 1311-14**C**

#### SuperCut-Schere mit Keramikbeschichtung (MC/CC)

- untere Schneide mit einem Rasierklingschliff (MC)
- obere Schneide mit einer Mikroverzahnung (MC)
- schwarze Keramikbeschichtung (CC)
- vergoldete Schraube
- die Artikelnummer endet mit dem Buchstaben / **N**

#### SuperCut Scissors with Ceramic Coating (MC/CC)

- lower blade with razor-sharp cut
- upper blade with micro serrated cut
- black ceramic coating
- gold plated rings
- the article number ends with the letter / **N**



ER 1314-14**N**

#### Hartmetallschere (TC)

- Schneiden aus Hartmetall
- vergoldete Ringe

#### Hard Metal Scissors (TC)

- blades with hard metal
- gold plated rings

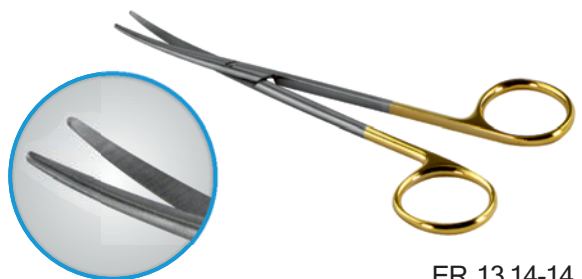

ER 1314-14



## Oberflächenbeschreibung Surface Description



ER 13 11-14C

### Hartmetallschere mit Keramikbeschichtung (TC/CC)

- Schneiden aus Hartmetall
- schwarze Keramikbeschichtung
- vergoldete Ringe, vergoldete Schraube
- die Artikelnummer endet mit dem Buchstaben / **C**

### Hard Metal Scissors with Ceramic Coating (TC/CC)

- blades with hard metal
- black ceramic coating,
- gold plated rings, gold plated screw
- the article number ends with the letter / **C**



ER 13 11-14M

### Hartmetall-SuperCut-Schere (TC/MC)

- Schneiden aus Hartmetall
- untere Schneide mit einem Rasierklingenschliff (MC)
- obere Schneide mit einer Mikroverzahnung (MC)
- lang vergoldete Ringe
- die Artikelnummer endet mit dem Buchstaben / **M**

### Hard Metal SuperCut Scissors (TC/MC)

- blades with hard metal
- lower blade with razor-sharp cut
- upper blade with micro serrated cut
- long gold plated rings
- the article number ends with the letter / **M**



ER 13 11-14N

### Hartmetall-SuperCut-Scheren mit Keramikbeschichtung (TC/MC/CC)

- Schneiden aus Hartmetall
- untere Schneide mit einem Rasierklingenschliff (MC)
- obere Schneide mit einer Mikroverzahnung (MC)
- schwarze Keramikbeschichtung (CC)
- vergoldete Ringe, vergoldete Schraube
- die Artikelnummer endet mit dem Buchstaben / **N**

### Hard Metal SuperCut Scissors with Ceramic Coating (TC/MC/CC)

- blades with hard metal
- lower blade with razor-sharp cut
- upper blade with micro serrated cut
- black ceramic coating,
- gold plated rings, gold plated screw
- the article number ends with the letter / **N**



ER 13 11-14W

### Hartmetallschere mit Wellenschliff (TC/W)

- Schneiden aus Hartmetall
- untere Schneide mit feinem Wellenschliff (W)
- vergoldete Ringe
- die Artikelnummer endet mit dem Buchstaben / **W**

### Hard Metal Scissors with Wavecut (TC/W)

- blades with hard metal
- lower blade with welded hard metal
- gold plated rings
- the article number ends with the letter / **W**





Iridektomieschere  
Iridectomy scissors



spitz / spitz  
sharp / sharp

12 cm - 4 3/4"

ER 2200-01



NOYES

Iridektomieschere  
Iridectomy scissors



spitz / spitz  
gebogen  
sharp / sharp  
curved

12 cm - 4 3/4"

ER 2201-01



NOYES

Sehnenschere  
Tenotomy scissors



WESTCOTT

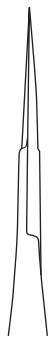

spitz / spitz  
gerade  
sharp / sharp  
straight

11,5 cm - 4 1/2"

ER 2240-11



gerade  
straight

ER 2260-08



gebogen  
curved

ER 2261-08



kniegebogen  
curved bent

ER 2262-08



aufgewinkelt  
angled up

ER 2263-08

8,5 cm - 3 1/4"

6 mm Blattlänge  
6 mm blade length



1:1  
VANNAS



Mikro Federscheren  
Micro Spring Scissors



spitz / spitz  
gebogen  
sharp / sharp  
curved

10 cm - 4"

ER 2300-10



1:1  
CASTROVIEJO



stumpf / stumpf  
gebogen  
blunt / blunt  
curved

10 cm - 4"

ER 2310-10



1:1  
CASTROVIEJO

Hornhautschere  
Corneal scissors



links  
left

10 cm - 4"

ER 2338-10



1:1  
CASTROVIEJO

Hornhautschere  
Corneal scissors



rechts  
right

10 cm - 4"

ER 2339-10



1:1  
CASTROVIEJO



Hornhautschere  
Corneal scissors



links  
left

11 cm - 4 1/4"

ER 2345-11

1:1  
CASTROVIEJO



Hornhautschere  
Corneal scissors

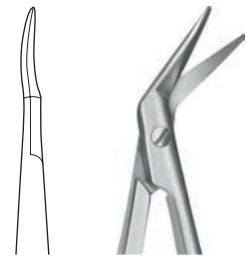

rechts  
right

11 cm - 4 1/4"

ER 2340-11

1:1  
CASTROVIEJO



Sehnenschere  
Tenotomy scissors



spitz / spitz  
gebogen  
sharp / sharp  
curved

11 cm - 4 1/4"

ER 2330-11

1:1  
WESTCOTT



Sehnenschere  
Tenotomy scissors



stumpf / stumpf  
gebogen  
blunt / blunt  
curved

11 cm - 4 1/4"

ER 2335-11

1:1  
WESTCOTT



## Mikro Federscheren Micro Spring Scissors

### Venenschere

- kein Abgleiten des Gefäßes
- glatte, saubere Durchtrennung

### Vein scissors

- vessel cannot slip off
- clean, smooth cut



13 cm - 5"

ER 2370-01



BIEMER



gerade  
straight



gebogen  
curved



|               |            |            |
|---------------|------------|------------|
| 12 cm - 4¾"   | ER 2254-02 | ER 2254-03 |
| 16 cm - 6¼"   | ER 2254-22 | ER 2254-23 |
| 18,5 cm - 7¼" | ER 2254-32 | ER 2254-33 |



bajonettförmig  
bayonet-shaped

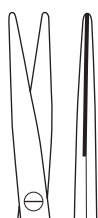

gerade  
straight



gebogen  
curved

|               |            |            |
|---------------|------------|------------|
| 16,5 cm - 6½" | ER 2252-28 | -          |
| 18,5 cm - 7½" | ER 2252-38 | -          |
| 20 cm - 8"    | ER 2252-48 | ER 2252-49 |
| 22,5 cm - 9"  | ER 2253-58 | ER 2253-59 |

14 mm Blattlänge  
14 mm blade length



gerade  
straight



gebogen  
curved



abwärts gebogen  
curved down

|               |            |            |            |
|---------------|------------|------------|------------|
| 16,5 cm - 6½" | ER 2252-22 | ER 2252-23 | -          |
| 20 cm - 8"    | ER 2252-42 | ER 2252-43 | ER 2252-41 |
| 22,5 cm - 9"  | ER 2253-52 | ER 2253-53 | -          |
| 24,5 cm - 9¾" | ER 2253-62 | ER 2253-63 | -          |





14 mm Blattlänge  
14 mm blade length

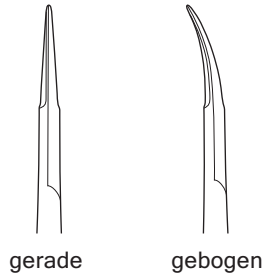

gerade gebogen

straight curved

|               |    |             |             |
|---------------|----|-------------|-------------|
| 14,5 cm - 5½" | TI | ER 2380-14T | ER 2388-14T |
| 15 cm - 6"    |    | ER 2380-16R | ER 2381-16R |

TI = Titan / Titanium



11 mm Blattlänge  
11 mm blade length

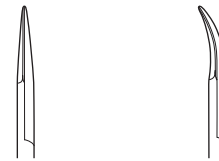

gerade gebogen  
straight curved

|             |             |             |
|-------------|-------------|-------------|
| 16 cm - 6¼" | ER 2370-16R | ER 2371-16R |
| 18 cm - 7"  | ER 2370-18R | ER 2371-18R |



JACOBSON

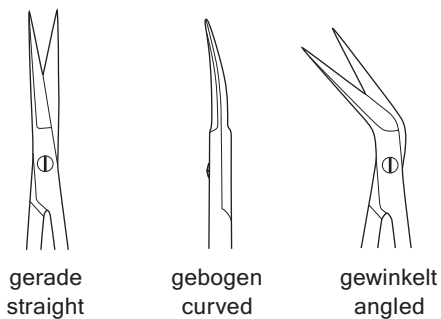

gerade gebogen gewinkelt  
straight curved angled

18,5 cm - 7¼"

|            |            |            |
|------------|------------|------------|
| ER 2350-18 | ER 2351-18 | ER 2352-18 |
|------------|------------|------------|



bajonettförmig  
bayonet-shaped

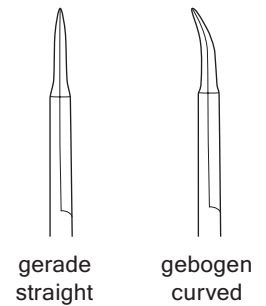

gerade gebogen  
straight curved

VANNAS

|             |            |            |
|-------------|------------|------------|
| 19 cm - 7½" | ER 2364-19 | ER 2365-19 |
|-------------|------------|------------|

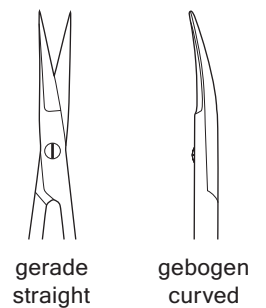

gerade gebogen  
straight curved

19 cm - 7½"

|            |            |
|------------|------------|
| ER 2360-19 | ER 2361-19 |
|------------|------------|









Feine Scheren  
Delicate Scissors



Augenschere  
Eye scissors

KNAPP

|   |   |   |  |   |   |
|---|---|---|--|---|---|
|  |  |  |  |  |  |
| stumpf / stumpf<br>blunt / blunt  | spitz / stumpf<br>sharp / blunt   | spitz / spitz<br>sharp / sharp  | stumpf / stumpf<br>blunt / blunt   | spitz / stumpf<br>sharp / blunt   | spitz / spitz<br>sharp / sharp  |
| gerade<br>straight  |   |   | gebogen<br>curved  |   |   |
| 10,5 cm - 4¼"   |   |   | 10,5 cm - 4¼"  |   |   |
| ER 2404-01  | ER 2404-02  | ER 2404-03  | ER 2405-01   | ER 2405-02  | ER 2405-03  |



Iris- und  
Fadenschere  
Iris- and  
suture scissors

|               |   |   |  |   |
|---------------|---|---|--|---|
|               |  |  |  |  |
|               | gerade<br>straight  | gebogen<br>curved   | gerade<br>straight   | gebogen<br>curved   |
| 9,5 cm - 3¾"  | ER 2420-09  | ER 2421-09  | ER 2422-09   | ER 2423-09  |
| 10,5 cm - 4¼" | ER 2420-10  | ER 2421-10  | ER 2422-10   | ER 2423-10  |
| 11,5 cm - 4½" | ER 2420-11  | ER 2421-11  | ER 2422-11   | ER 2423-11  |

FINO



#### Irisschere mit lachen Branchen

*Iris scissors with »Ribbon Type«*



gerade  
straight

gebogen  
curved

10,5 cm - 4½"

ER 2473-02

ER 2473-03



spitz / spitz  
sharp / sharp

#### Irisschere mit lachen Branchen

*Iris scissors with »Ribbon Type«*



gerade  
straight

gebogen  
curved

10,5 cm - 4½"

ER 2474-02

ER 2474-03



stumpf / stumpf  
blunt / blunt

#### Irisschere mit lachen Branchen

*Iris scissors with »Ribbon Type«*



gerade  
straight

gebogen  
curved

10,5 cm - 4¼"

ER 2476-02

ER 2476-03



spitz / spitz  
sharp / sharp

WALTON

#### Irisschere mit lachen Branchen

*Iris scissors with »Ribbon Type«*



gerade  
straight

gebogen  
curved

9,5 cm - 3¾"

ER 2477-02

ER 2477-03



stumpf / stumpf  
blunt / blunt

STEVENS

#### Irisschere mit lachen Branchen

*Iris scissors with »Ribbon Type«*



gerade  
straight

gebogen  
curved

9,5 cm - 3¾"

ER 2478-02



spitz / spitz  
sharp / sharp



spitz / spitz  
sharp / sharp



gerade  
straight

gebogen  
curved

11,5 cm - 4½"

|            |            |
|------------|------------|
| ER 2510-11 | ER 2512-12 |
|------------|------------|



stumpf / stumpf  
blunt / blunt



gerade  
straight

gebogen  
curved

11,5 cm - 4½"

|            |            |
|------------|------------|
| ER 2516-11 | ER 2518-11 |
|------------|------------|



gerade  
straight

gebogen  
curved





| Typ / Type | 9 cm - 3½"  |             |
|------------|-------------|-------------|
|            | ER 1630-09  | ER 1631-09  |
| MC         |             | ER 1631-09M |
| TC         | ER 2406-09  | ER 2407-09  |
| TC/MC      | ER 2406-09M | ER 2407-09M |
| TC/MC/CC   | ER 2406-09N | ER 2407-09N |

MC = SuperCut-Schere / SuperCut scissors  
TC = Hartmetallschere / hard metal scissors

CC = Keramikbeschichtete Schere / Ceramic coated scissors  
W = Wellenschliff-Schere / Wavecut scissors









|   |   |   |   |
|---|---|---|---|
|  |  |  |  |
| stumpf / stumpf<br>blunt / blunt  | spitz / stumpf<br>sharp / blunt   | stumpf / stumpf<br>blunt / blunt  | spitz / stumpf<br>sharp / blunt   |
| gerade<br>straight  |   | gebogen<br>curved   |   |
| 11,5 cm - 4½"   |   | 11,5 cm - 4½"   |   |
| ER 2396-01  | ER 2396-02  | ER 2397-01  | ER 2397-02  |



große Ringe  
large Rings

|   |   |   |   |            |
|---|---|---|---|------------|
|  |  |  |  |            |
| gerade<br>straight  | gebogen<br>curved   | abgewinkelt<br>angled   | sichelförmig<br>sickle shaped   |            |
| 11,5 cm - 4½"   |   |   |   |            |
| Typ / Type  | ER 1630-11  | ER 1631-11  | ER 2414-11  | ER 2416-11 |

spitz / spitz  
sharp / sharp





WALTON



gebogen  
curved

10 cm - 4"

ER 1638-10



SANVENERO

gerade  
straight

14,5 cm - 5 7/8"

ER 1640-14



SANVENERO



gebogen  
curved

14,5 cm - 5 7/8"

ER 1641-14



stumpf / stumpf  
blunt / blunt

Fig. 1



spitz / stumpf  
sharp / blunt

Fig. 2

|                | gerade<br>straight | gebogen<br>curved | gerade<br>straight | gebogen<br>curved |
|----------------|--------------------|-------------------|--------------------|-------------------|
| 12 cm - 4 3/4" | ER 1501-12         | ER 1511-12        | ER 1502-12         | ER 1512-12        |

MC = SuperCut-Schere / SuperCut scissors  
TC = Hartmetallschere / hard metal scissors

CC = Keramikbeschichtete Schere / Ceramic coated scissors  
W = Wellenschliff-Schere / Wavecut scissors



spitz / spitz  
sharp / sharp

Fig. 3

|             | Typ<br>Type | gerade<br>straight | gebogen<br>curved |
|-------------|-------------|--------------------|-------------------|
| 12 cm - 4¾" |             | ER 1503-12         | ER 1513-12        |



stumpf / stumpf  
blunt / blunt

Fig. 1



spitz / stumpf  
sharp / blunt

Fig. 2

|             | gerade<br>straight | gebogen<br>curved | gerade<br>straight | gebogen<br>curved |
|-------------|--------------------|-------------------|--------------------|-------------------|
| 12 cm - 4¾" | ER 1521-12         | ER 1524-12        | ER 1522-12         | ER 1525-12        |



WAGNER



spitz / spitz  
sharp / sharp

Fig. 3

|             | Typ<br>Type | gerade<br>straight | gebogen<br>curved |
|-------------|-------------|--------------------|-------------------|
| 12 cm - 4¾" |             | ER 1523-12         | ER 1526-12        |



WAGNER

MC = SuperCut-Schere / SuperCut scissors  
TC = Hartmetallschere / hard metal scissors

CC = Keramikbeschichtete Schere / Ceramic coated scissors  
W = Wellenschliff-Schere / Wavecut scissors



## Chirurgische Scheren Surgical Scissors



BROPHY (SULLIVAN)



spitz / spitz  
sharp / sharp

gerade  
straight

14,5 cm - 5¾"

ER 1550-14



BROPHY (SULLIVAN)



spitz / spitz  
sharp / sharp

gebogen  
curved

14,5 cm - 5¾"

ER 1551-14



stumpf / stumpf  
blunt / blunt

|               | Typ<br>Type | gerade<br>straight | gebogen<br>curved |
|---------------|-------------|--------------------|-------------------|
| 12 cm - 4½"   |             | ER 1001-11         | ER 1011-11        |
| 13 cm - 5"    |             | ER 1001-13         | ER 1011-13        |
| 14,5 cm - 5¾" |             | ER 1001-14         | ER 1011-14        |
|               | TC          | ER 1004-14         | ER 1014-14        |
| 15,5 cm - 6"  |             | ER 1001-15         | ER 1011-15        |
| 16,5 cm - 6½" |             | ER 1001-16         | ER 1011-16        |
| 17,5 cm - 7"  |             | ER 1001-17         | ER 1011-17        |
| 18,5 cm - 7"  |             | ER 1001-18         | ER 1011-18        |



spitz / stumpf  
sharp / blunt

|               | Typ<br>Type | gerade<br>straight | gebogen<br>curved |
|---------------|-------------|--------------------|-------------------|
| 12 cm - 4½"   |             | ER 1002-11         | ER 1012-11        |
| 13 cm - 5"    |             | ER 1002-13         | ER 1012-13        |
| 14,5 cm - 5¾" |             | ER 1002-14         | ER 1012-14        |
|               | MC          | ER 1002-14M        | ER 1012-14M       |
|               | TC          | ER 1006-14         | ER 1016-14        |
| 15,5 cm - 6"  |             | ER 1002-15         | ER 1012-15        |
| 16,5 cm - 6½" |             | ER 1002-16         | ER 1012-16        |
| 17,5 cm - 7"  |             | ER 1002-17         | ER 1012-17        |
| 18,5 cm - 7½" |             | ER 1002-18         | ER 1012-18        |
| 20 cm - 8"    |             | ER 1002-20         | ER 1012-20        |

MC = SuperCut-Schere / SuperCut scissors  
TC = Hartmetallschere / hard metal scissors

CC = Keramikbeschichtete Schere / Ceramic coated scissors  
W = Wellenschliff-Schere / Wavecut scissors



|               | Typ<br>Type | gerade<br>straight | gebogen<br>curved |
|---------------|-------------|--------------------|-------------------|
| 12 cm - 4½"   |             | ER 1003-11         | ER 1013-11        |
| 13 cm - 5"    |             | ER 1003-13         | ER 1013-13        |
| 14,5 cm - 5¾" |             | ER 1003-14         | ER 1013-14        |
|               | TC          | ER 1008-14         | ER 1018-14        |
| 15,5 cm - 6"  |             | ER 1003-15         | ER 1013-15        |
| 16,5 cm - 6½" |             | ER 1003-16         | ER 1013-16        |
| 18,5 cm - 7¼" |             | ER 1003-18         | ER 1013-18        |



spitz / spitz  
sharp / sharp



stumpf / stumpf  
blunt / blunt



spitz / stumpf  
sharp / blunt



spitz / spitz  
sharp / sharp

schlankes Modell  
slender pattern



|               | gerade<br>straight | gebogen<br>curved | gerade<br>straight | gebogen<br>curved | gerade<br>straight | gebogen<br>curved |
|---------------|--------------------|-------------------|--------------------|-------------------|--------------------|-------------------|
| 13 cm - 5"    | ER 1021-13         | ER 1031-13        | ER 1022-13         | ER 1032-13        | ER 1023-13         | ER 1033-13        |
| 14,5 cm - 5¾" | ER 1021-14         | ER 1031-14        | ER 1022-14         | ER 1032-14        | ER 1023-14         | ER 1033-14        |

MC = SuperCut-Schere / SuperCut scissors  
TC = Hartmetallschere / hard metal scissors

CC = Keramikbeschichtete Schere / Ceramic coated scissors  
W = Wellenschliff-Schere / Wavecut scissors



DEAVER

14,5 cm - 5¾"



spitz / stumpf  
sharp / blunt

gerade  
straight

gebogen  
curved

ER 1040-14

ER 1041-14



14,5 cm - 5¾"

ER 1122-14



RICHTER

stumpf / stumpf  
seitwärts abgewinkelt  
blunt / blunt  
angled to side



Inzisionsschere  
Incision scissors



gerade  
straight

13 cm - 5"

ER 1110-13

14,5 cm - 5¾"

ER 1110-14

16,5 cm - 6½"

ER 1110-16



18,5 cm - 7¼"

ER 1130-18



FERGUSSON

stumpf / stumpf  
gebogen  
blunt / blunt  
curved





gerade  
straight



gebogen  
curved



gerade  
straight



gebogen  
curved

Sehnenschere  
Tenotomy scissors



STEVENS

| Typ<br>Type   |    | spitz<br>sharp |            | stumpf<br>blunt |             |
|---------------|----|----------------|------------|-----------------|-------------|
| 10,5 cm - 4¼" |    | ER 2430-10     | ER 2431-10 | ER 2440-10      | ER 2441-10  |
|               | MC |                |            | ER 2440-10M     | ER 2441-10M |
| 11,5 cm - 4½" |    | ER 2430-11     | ER 2431-11 | ER 2440-11      | ER 2441-11  |
|               | MC | ER 2430-11M    |            | ER 2440-11M     | ER 2441-11M |
|               | TC |                |            | ER 2440-51      | ER 2441-51  |



gerade  
straight



gebogen  
curved



MOD. BONN

| Typ / Type | 9 cm - 3½"  |             |
|------------|-------------|-------------|
|            | ER 2450-08  | ER 2451-08  |
| MC         | ER 2450-08M | ER 2451-08M |



kniegebogen  
curved bent



WILMER

| Typ / Type | 10 cm - 4" |
|------------|------------|
|            | ER 2457-10 |



gerade  
straight



gebogen  
curved

Strabismusschere  
Strabismus scissors



| Typ / Type | 11,5 cm - 4½" |             |
|------------|---------------|-------------|
|            | ER 2460-11    | ER 2461-11  |
| TC         | ER 2462-11    | ER 2463-11  |
| TC/MC      | ER 2462-11M   | ER 2463-11M |
| TC/MC/CC   |               | ER 2463-11N |

MC = SuperCut-Schere / SuperCut scissors  
TC = Hartmetallschere / hard metal scissors

CC = Keramikbeschichtete Schere / Ceramic coated scissors  
W = Wellenschliff-Schere / Wavecut scissors



oberes Blatt  
mikrofein gezahnt  
micro serrated  
upper blade



gerade  
straight



gebogen  
curved

13 cm - 5"

|            |            |
|------------|------------|
| ER 2900-13 | ER 2901-13 |
|------------|------------|

GOLDMANN-FOX

Zahnfleischschere  
Gum Scissors



oberes Blatt  
mikrofein gezahnt  
micro serrated  
upper blade



gerade  
straight



gebogen  
curved

13 cm - 5"

|            |            |            |
|------------|------------|------------|
| Typ / Type | 13 cm - 5" |            |
| TC         | ER 2902-13 | ER 2903-13 |

GOLDMANN-FOX



gebogen  
curved

|            |             |
|------------|-------------|
| Typ / Type | 13 cm - 5"  |
| MC         | ER 2901-13M |
| MC/CC      | ER 2901-13N |
| TC/MC      | ER 2903-13M |

GOLDMANN-FOX



oberes Blatt  
mikrofein gezahnt  
micro serrated  
upper blade

S-gebogen  
S-curved



gerade  
straight

13 cm - 5"

ER 2905-13

GOLDMANN-FOX (SPEZIAL)

MC = SuperCut-Schere / SuperCut scissors  
TC = Hartmetallschere / hard metal scissors

CC = Keramikbeschichtete Schere / Ceramic coated scissors  
W = Wellenschliff-Schere / Wavecut scissors



gerade  
straight

|            |             |
|------------|-------------|
| Typ / Type | 13 cm - 5"  |
| MC         | ER 2905-13M |



S-gebogen  
S-curved

GOLDMANN-FOX (SPEZIAL)



gerade  
straight



gebogen  
curved



gerade  
straight



gebogen  
curved

|            |              |            |            |            |
|------------|--------------|------------|------------|------------|
| Typ / Type | 15,5 cm - 6" |            | 18 cm - 7" |            |
|            | ER 1580-15   | ER 1581-15 | ER 1580-18 | ER 1581-18 |



REYNOLDS

MC = SuperCut-Schere / SuperCut scissors  
TC = Hartmetallschere / hard metal scissors

CC = Keramikbeschichtete Schere / Ceramic coated scissors  
W = Wellenschliff-Schere / Wavecut scissors



## Enukleationsscheren Enucleation Scissors

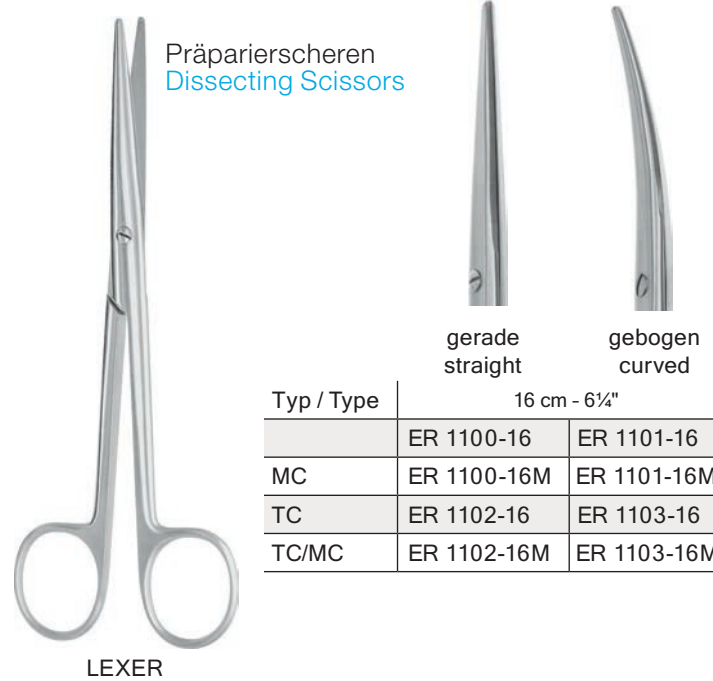

| Typ / Type | 16 cm - 6¼"        |                   |
|------------|--------------------|-------------------|
|            | gerade<br>straight | gebogen<br>curved |
|            | ER 1100-16         | ER 1101-16        |
| MC         | ER 1100-16M        | ER 1101-16M       |
| TC         | ER 1102-16         | ER 1103-16        |
| TC/MC      | ER 1102-16M        | ER 1103-16M       |

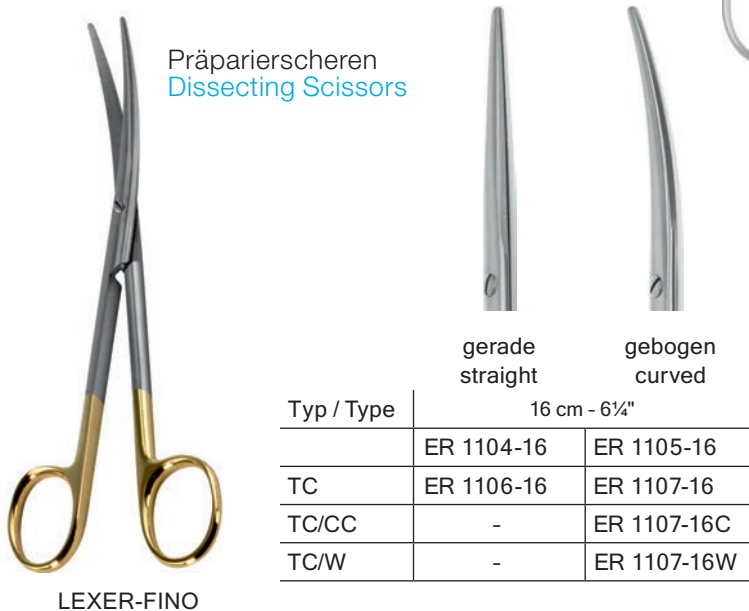

| Typ / Type | 16 cm - 6¼"        |                   |
|------------|--------------------|-------------------|
|            | gerade<br>straight | gebogen<br>curved |
|            | ER 1104-16         | ER 1105-16        |
| TC         | ER 1106-16         | ER 1107-16        |
| TC/CC      | -                  | ER 1107-16C       |
| TC/W       | -                  | ER 1107-16W       |

MC = SuperCut-Schere / SuperCut scissors  
TC = Hartmetallschere / hard metal scissors

CC = Keramikbeschichtete Schere / Ceramic coated scissors  
W = Wellenschliff-Schere / Wavecut scissors



| Typ / Type | 14,5 cm - 5¾" | 15 cm - 6" | 17 cm - 6¾" |
|------------|---------------|------------|-------------|
|            | ER 1250-14    | ER 1250-15 | ER 1250-17  |
| MC         | ER 1250-14M   |            | ER 1250-17M |
| TC         | ER 1252-14    |            | ER 1252-17  |
| TC/MC      | ER 1252-14M   |            | ER 1252-17M |



gerade  
straight

MAYO



| Typ / Type | 20 cm - 8" | 23 cm - 9"  |
|------------|------------|-------------|
|            | ER 1250-20 | ER 1250-23  |
| MC         |            | ER 1250-23M |
| TC         |            | ER 1252-23  |
| TC/MC      |            | ER 1252-23M |



gerade  
straight

MAYO

MC = SuperCut-Schere / SuperCut scissors  
TC = Hartmetallschere / hard metal scissors

CC = Keramikbeschichtete Schere / Ceramic coated scissors  
W = Wellenschliff-Schere / Wavecut scissors



## Präparierscheren Dissecting Scissors



gebogen  
curved

MAYO



| Typ / Type | 14 cm - 5½" | 15 cm - 6" | 17 cm - 6¾" |
|------------|-------------|------------|-------------|
|            | ER 1251-14  | ER 1251-15 | ER 1251-17  |
| MC         | ER 1251-14M | -          | ER 1251-17M |
| CC         | ER 1251-14C | -          | ER 1251-17C |
| TC         | ER 1253-14  | -          | ER 1253-17  |
| TC/MC      | ER 1253-14M | -          | ER 1253-17M |



gebogen  
curved

MAYO



| Typ / Type | 20 cm - 8" | 23 cm - 9"  | 28 cm - 11" |
|------------|------------|-------------|-------------|
|            | ER 1251-20 | ER 1251-23  | ER 1251-28  |
| MC         | -          | ER 1251-23M | ER 1251-28M |
| CC         | -          | ER 1251-23C | -           |
| TC         | -          | ER 1253-23  | -           |
| TC/MC      | -          | ER 1253-23M | -           |

MC = SuperCut-Schere / SuperCut scissors  
TC = Hartmetallschere / hard metal scissors

CC = Keramikbeschichtete Schere / Ceramic coated scissors  
W = Wellenschliff-Schere / Wavecut scissors





gerade  
straight



| Typ / Type | 15 cm - 6"  | 17 cm - 6¾" | 19 cm - 7½" |
|------------|-------------|-------------|-------------|
|            | ER 1260-15  | ER 1260-17  | ER 1260-19  |
| MC         | ER 1260-15M | ER 1260-17M | -           |
| CC         | ER 1260-15C | ER 1260-17C | -           |
| TC         | ER 1262-15  | ER 1262-17  | -           |
| TC/MC      | ER 1262-15M | ER 1262-17M | -           |



MAYO-STILLE

gebogen  
curved



| Typ / Type | 15 cm - 6"  | 17 cm - 6¾" | 19 cm - 7½" | 21 cm - 8¼" |
|------------|-------------|-------------|-------------|-------------|
|            | ER 1261-15  | ER 1261-17  | ER 1261-19  | ER 1261-21  |
| MC         | ER 1261-15M | ER 1261-17M | -           | -           |
| CC         | ER 1261-15C | ER 1261-17C | -           | -           |
| TC         | ER 1263-15  | ER 1263-17  | -           | -           |
| TC/MC      | ER 1263-15M | ER 1263-17M | -           | -           |



MAYO-STILLE

MC = SuperCut-Schere / SuperCut scissors  
TC = Hartmetallschere / hard metal scissors

CC = Keramikbeschichtete Schere / Ceramic coated scissors  
W = Wellenschliff-Schere / Wavecut scissors



## Präparierscheren Dissecting Scissors



MAYO-NOBLE



gerade  
straight

17 cm - 6¾"

ER 1270-17



MAYO-NOBLE



gebogen  
curved

17 cm - 6¾"

ER 1271-17



BABY-METZENBAUM



gerade  
straight



gebogen  
curved

| Typ / Type | 11,5 cm - 4½" |             |
|------------|---------------|-------------|
|            | ER 1280-11    | ER 1281-11  |
| MC         | ER 1280-11M   | ER 1281-11M |
|            | -             | -           |
| TC         | ER 1280-51    | ER 1281-51  |

MC = SuperCut-Schere / SuperCut scissors  
TC = Hartmetallschere / hard metal scissors

CC = Keramikbeschichtete Schere / Ceramic coated scissors  
W = Wellenschliff-Schere / Wavecut scissors



stumpf / stumpf  
blunt / blunt

gerade  
straight

gebogen  
curved

| Typ / Type | 14,5 cm - 5¾" |             |
|------------|---------------|-------------|
|            | ER 1290-14    | ER 1291-14  |
| MC         | ER 1290-14M   | ER 1291-14M |
| CC         | ER 1290-14C   | ER 1291-14C |
| TC         | ER 1306-14    | ER 1316-14  |
| TC/MC      | ER 1306-14M   | ER 1316-14M |



METZENBAUM-FINO



stumpf / stumpf  
blunt / blunt

gebogen  
curved

gerade  
straight

gebogen  
curved

| Typ / Type | 13 cm -    | 14,5 cm - 5¾" |              |
|------------|------------|---------------|--------------|
|            | ER 1311-13 | ER 1301-14    | ER 1311-14   |
| MC         | -          | ER 1301-14M   | ER 1311-14M  |
| CC         | -          | ER 1301-14C   | ER 1311-14C  |
| TC         | -          | ER 1304-14    | ER 1314-14   |
|            |            | -             | ER 1314-14RS |
| TC/MC      | -          | ER 1304-14M   | ER 1314-14M  |
| TC/CC      | -          | ER 1304-14C   | ER 1314-14C  |



METZENBAUM

MC = SuperCut-Schere / SuperCut scissors  
TC = Hartmetallschere / hard metal scissors

CC = Keramikbeschichtete Schere / Ceramic coated scissors  
W = Wellenschliff-Schere / Wavecut scissors



METZENBAUM-FINO



gerade  
straight



gebogen  
curved



gerade  
straight



gebogen  
curved

| Typ / Type | 18 cm - 7"  |             | 20 cm - 8"  |             |
|------------|-------------|-------------|-------------|-------------|
|            | ER 1320-18  | ER 1330-18  | ER 1320-20  | ER 1330-20  |
| MC         | ER 1320-18M | ER 1330-18M | -           | ER 1330-20M |
| CC         | ER 1320-18C | ER 1330-18C | -           | -           |
| TC         | ER 1326-18  | ER 1336-18  | ER 1326-20  | ER 1336-20  |
| TC/MC      | ER 1326-18M | ER 1336-18M | -           | ER 1336-20M |
| TC/CC      | ER 1326-18C | ER 1336-18C | ER 1326-20C | ER 1336-20C |



METZENBAUM



gerade  
straight



gebogen  
curved



gerade  
straight



gebogen  
curved

| Typ / Type | 18 cm - 7"  |             | 20 cm - 8"  |             |
|------------|-------------|-------------|-------------|-------------|
|            | ER 1321-18  | ER 1331-18  | ER 1321-20  | ER 1331-20  |
| MC         | ER 1321-18M | ER 1331-18M | ER 1321-20M | ER 1331-20M |
| CC         | ER 1321-18C | ER 1331-18C | -           | ER 1331-20C |
| MC/CC      | -           | ER 1331-18N | -           | -           |
| TC         | ER 1324-18  | ER 1334-18  | ER 1324-20  | ER 1334-20  |
| TC/MC      | ER 1324-18M | ER 1334-18M | -           | ER 1334-20M |
| TC/MC/CC   | -           | ER 1334-18N | -           | -           |
| TC/CC      | ER 1324-18C | ER 1334-18C | ER 1324-20C | ER 1334-20C |
| TC/W       | -           | ER 1334-18W | -           | -           |

MC = SuperCut-Schere / SuperCut scissors  
TC = Hartmetallschere / hard metal scissors

CC = Keramikbeschichtete Schere / Ceramic coated scissors  
W = Wellenschliff-Schere / Wavecut scissors



1 Blatt gezahnt  
1 blade serrated

gebogen  
curved

|            |              |
|------------|--------------|
| Typ / Type | 18 cm - 7"   |
| TC         | ER 1334-18RS |



METZENBAUM



gerade  
straight



gebogen  
curved



gebogen  
curved

| Typ / Type | 23 cm - 9"  |             | 28 cm - 11" |
|------------|-------------|-------------|-------------|
|            | ER 1320-23  | ER 1330-23  | ER 1330-28  |
| MC         | -           | ER 1330-23M | -           |
| CC         | -           | ER 1330-23C | -           |
| TC         | ER 1326-23  | ER 1336-23  | ER 1336-28  |
| TC/MC      | ER 1326-23M | ER 1336-23M | -           |
| TC/CC      | ER 1326-23C | ER 1336-23C | -           |



METZENBAUM-FINO

MC = SuperCut-Schere / SuperCut scissors  
TC = Hartmetallschere / hard metal scissors  
RS = gezahnt / saw edge

CC = Keramikbeschichtete Schere / Ceramic coated scissors  
W = Wellenschliff-Schere / Wavecut scissors  
S = Supreme



METZENBAUM



gerade  
straight

gebogen  
curved

gerade  
straight

gebogen  
curved

| Typ / Type | 28 cm - 11" |             | 30 cm - 11¼" |             |
|------------|-------------|-------------|--------------|-------------|
|            | ER 1321-28  | ER 1331-28  | ER 1321-30   | ER 1331-30  |
| MC         | -           | ER 1331-28M | -            | ER 1331-30M |
| TC         | ER 1324-28  | ER 1334-28  | ER 1324-30   | ER 1334-30  |



METZENBAUM-S



S-gebogen  
S-curved



| Typ / Type | 18 cm - 7" | 20 cm - 8" | 23 cm - 9" |
|------------|------------|------------|------------|
| TC         | ER 1339-18 | ER 1339-20 | ER 1339-23 |



WELLER



gebogen  
curved

|             |            |
|-------------|------------|
| 28 cm - 11" | ER 1350-28 |
|-------------|------------|

MC = SuperCut-Schere / SuperCut scissors  
TC = Hartmetallschere / hard metal scissors

CC = Keramikbeschichtete Schere / Ceramic coated scissors  
W = Wellenschliff-Schere / Wavecut scissors





#### Face Lift und Nasenscheren Face Lift and Nasal Scissors



gerade  
straight

10 cm - 4"

ER 1650-10



gebogen  
curved

ER 1651-10



BABY-LEXER (KNAPP)



gerade  
straight

Typ / Type

TC/W



gebogen  
curved

ER 1666-64

ER 1667-64W



fein  
delicate

PECK-JOSEPH



gebogen  
curved

Typ / Type

MC

14,5 cm - 5¾"

ER 1677-13M



REYNOLDS



gerade  
straight

Typ / Type

MC

TC

TC/MC

14 cm - 5½"

ER 1670-14

ER 1670-14M

-

-



gebogen  
curved

ER 1671-14

ER 1671-14M

ER 1671-54

ER 1671-54M



JOSEPH

MC = SuperCut-Schere / SuperCut scissors  
TC = Hartmetallschere / hard metal scissors

CC = Keramikbeschichtete Schere / Ceramic coated scissors  
W = Wellenschliff-Schere / Wavecut scissors



KILNER



gebogen  
curved

| Typ / Type | 12,5 cm - 5" | 13,5 cm - 5¼" | 15,5 cm - 6" |
|------------|--------------|---------------|--------------|
|            | ER 1675-12   | ER 1675-13    | ER 1675-15   |
| MC         | ER 1675-12M  | -             | -            |
| CC         | ER 1675-12C  | -             | -            |
| TC         | ER 1675-52   | -             | -            |



FREEMAN-KAYE

oberes Blatt  
mikrofein gezahnt  
micro serrated  
upper blade  
fein  
delicate



gebogen  
curved

| Typ / Type | 18 cm - 7" |
|------------|------------|
| TC         | ER 1681-78 |



FREEMAN-GORNEY

beide Blätter gezahnt  
both Blades serrated



gerade  
straight



gebogen  
curved

| Typ / Type | 19 cm - 7½" |             |
|------------|-------------|-------------|
| MC         | ER 1682-19M | ER 1683-19M |
| TC/MC      | ER 1682-59M | ER 1683-59M |

MC = SuperCut-Schere / SuperCut scissors  
TC = Hartmetallschere / hard metal scissors

CC = Keramikbeschichtete Schere / Ceramic coated scissors  
W = Wellenschliff-Schere / Wavecut scissors



|            |               |             |
|------------|---------------|-------------|
| Typ / Type | 18,5 cm - 7¼" |             |
| MC         | ER 1688-19M   | ER 1689-19M |

GORNEY



|            |             |
|------------|-------------|
| Typ / Type | 16 cm - 6¼" |
| MC         | ER 1687-16M |
| TC/MC      | ER 1687-56M |

CASTANARES



|            |             |             |
|------------|-------------|-------------|
| Typ / Type | 23 cm - 9"  |             |
| MC         | ER 1690-23M | ER 1691-23M |



GORNEY

MC = SuperCut-Schere / SuperCut scissors  
 TC = Hartmetallschere / hard metal scissors

CC = Keramikbeschichtete Schere / Ceramic coated scissors  
 W = Wellenschliff-Schere / Wavecut scissors



HEYMANN

seitlich abgewinkelt  
angled to side

|            |             |
|------------|-------------|
| Typ / Type | 18 cm - 7"  |
|            | ER 2115-18  |
| MC         | ER 2115-18M |
| TC         | ER 2115-58  |



HEYMANN

seitlich abgewinkelt  
angled to side

|  |               |
|--|---------------|
|  | 19,5 cm - 7¾" |
|  | ER 2116-19    |



gezahnt  
saw edge

seitlich abgewinkelt  
angled to side

|  |             |
|--|-------------|
|  | 19 cm - 7½" |
|  | ER 2117-18  |



KILNER



gerade  
straight

|  |               |
|--|---------------|
|  | 11,5 cm - 4½" |
|  | ER 2124-11    |

MC = SuperCut-Schere / SuperCut scissors  
TC = Hartmetallschere / hard metal scissors

CC = Keramikbeschichtete Schere / Ceramic coated scissors  
W = Wellenschliff-Schere / Wavecut scissors



FOMON

abgewinkelt  
angled

|            |             |
|------------|-------------|
| Typ / Type | 13 cm - 5"  |
|            | ER 2130-13  |
| MC         | ER 2130-13M |



FOMON

schlankes Modell  
slender pattern

abgewinkelt, lach  
angled, lat

|            |               |
|------------|---------------|
| Typ / Type | 13,5 cm - 5¼" |
|            | ER 2131-13    |
| MC         | ER 2131-13M   |



FOMON



gebogen  
curved

|            |               |
|------------|---------------|
| Typ / Type | 13,5 cm - 5¼" |
|            | ER 2132-13    |
| MC         | ER 2132-13M   |



COTTLE

abgewinkelt  
angled

|            |             |
|------------|-------------|
| Typ / Type | 16 cm - 6¼" |
|            | ER 2135-16  |
| MC         | ER 2135-16M |

MC = SuperCut-Schere / SuperCut scissors  
TC = Hartmetallschere / hard metal scissors

CC = Keramikbeschichtete Schere / Ceramic coated scissors  
W = Wellenschliff-Schere / Wavecut scissors



FOMON

abgewinkelt  
angled

|            |            |
|------------|------------|
| Typ / Type | 13 cm - 5" |
| TC         | ER 2129-13 |



COTTLE



abgewinkelt  
angled

|            |             |
|------------|-------------|
| Typ / Type | 16 cm - 6¼" |
| TC         | ER 2136-16  |

MC = SuperCut-Schere / SuperCut scissors  
TC = Hartmetallschere / hard metal scissors

CC = Keramikbeschichtete Schere / Ceramic coated scissors  
W = Wellenschliff-Schere / Wavecut scissors





Speichelgangschere  
mit Knopf  
Saliva scissors  
probe-pointed



seitlich gebogen  
curved sideways

10 cm - 4"

ER 1706-10



spitz / spitz  
sharp / sharp



abgewinkelt  
angled

19,5 cm - 7¾"

ER 1710-19



POTTS-SMITH

stumpf / stumpf  
blunt / blunt  
Knorpelschere  
Cartilage Scissors



gebogen, gezahnt  
curved, saw edge

20 cm - 8"

ER 1725-19



MARTIN-CARTILAGE 1:3

Gefäßschere  
mit Knopf  
Vascular scissors  
probe-pointed



gerade  
straight

11,5 cm - 4½"

ER 1705-11



MC = SuperCut-Schere / SuperCut scissors  
TC = Hartmetallschere / hard metal scissors

CC = Keramikbeschichtete Schere / Ceramic coated scissors  
W = Wellenschliff-Schere / Wavecut scissors



Kapselschere  
Capsule Scissors



Knorpelschere  
Cartilage Scissors



Diese Abbildung zeigt die »MC Oberfl ächen-  
beschreibung«.

This illustration shows the »MC Surface  
Description«.

MC = SuperCut-Schere / SuperCut scissors  
TC = Hartmetallschere / hard metal scissors

CC = Keramikbeschichtete Schere / Ceramic coated scissors  
W = Wellenschliff-Schere / Wavecut scissors



stumpf / stumpf  
blunt / blunt

S-gebogen  
S-curved

25 cm - 10"

ER 1740-24

SATINSKY

Thorax Scheren  
Thorax Scissors

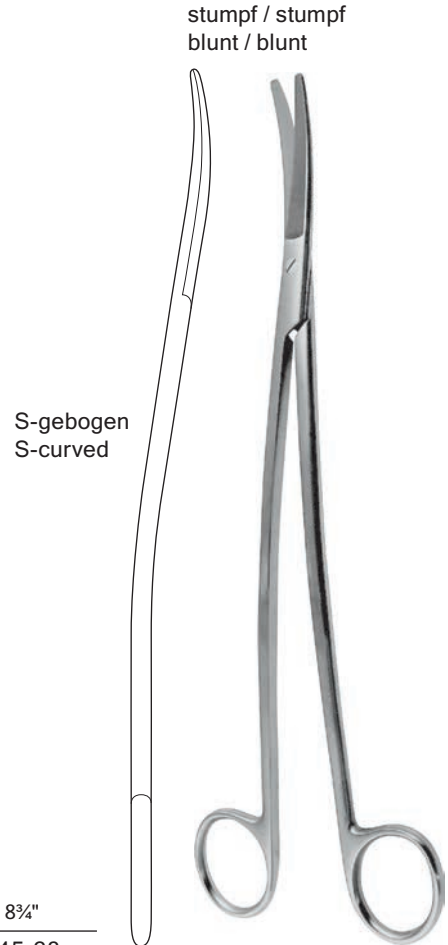

stumpf / stumpf  
blunt / blunt

S-gebogen  
S-curved

Typ / Type

22 cm - 8¾"

ER 1745-23

KLINGENBERG-LOTH



25°

45°

60°

| Typ / Type | 18,5 cm - 7¼" |             | 18 cm - 7"  |
|------------|---------------|-------------|-------------|
|            | ER 1720-19    | ER 1721-19  | ER 1722-19  |
| MC         | ER 1720-19M   | ER 1721-19M | ER 1722-19M |
| TC         | ER 1724-25    | ER 1724-45  | ER 1724-60  |



POTTS-SMITH

MC = SuperCut-Schere / SuperCut scissors  
TC = Hartmetallschere / hard metal scissors

CC = Keramikbeschichtete Schere / Ceramic coated scissors  
W = Wellenschliff-Schere / Wavecut scissors



## Gefäßscheren Vascular Scissors



DE BAKEY

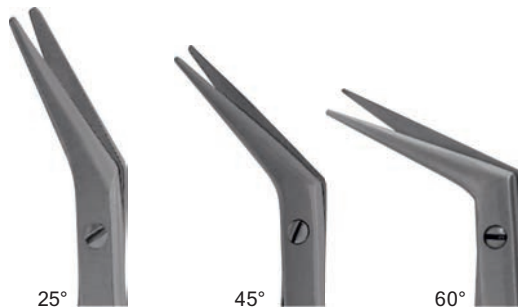

|            |             |               |             |
|------------|-------------|---------------|-------------|
| Typ / Type | 17 cm - 6¾" | 16,5 cm - 6½" | 16 cm - 6¼" |
|            | ER 1750-16  | ER 1752-16    | ER 1754-16  |
| TC         | ER 1755-25  | ER 1755-45    | ER 1755-60  |

|            |            |               |             |
|------------|------------|---------------|-------------|
| Typ / Type | 23 cm - 9" | 22,5 cm - 8¾" | 22 cm - 8¾" |
|            | ER 1750-23 | ER 1752-23    | ER 1754-23  |
| TC         | ER 1756-25 | ER 1756-45    | ER 1756-60  |



HEGEMANN-DIETHRICH



|            |               |             |             |               |             |
|------------|---------------|-------------|-------------|---------------|-------------|
| Typ / Type | 13,5 cm - 5¼" |             | 13 cm - 5"  | 13,5 cm - 5¼" | -           |
|            | ER 1760-13    | ER 1761-13  | ER 1762-13  | ER 1763-13    | -           |
|            | 16 cm - 6¼"   |             | 16 cm - 6¼" | 16 cm - 6¼"   |             |
|            | ER 1760-16    | ER 1761-16  | ER 1762-16  | ER 1763-16    | ER 1764-16  |
|            | 18 cm - 7"    |             | 18 cm - 7"  | 18 cm - 7"    |             |
|            | ER 1760-19    | ER 1761-19  | ER 1762-19  | ER 1763-19    | ER 1764-19  |
| MC         | ER 1760-19M   | ER 1761-19M | ER 1762-19M | ER 1763-19M   | ER 1764-19M |
| MC/CC      | -             | ER 1761-19N | -           | -             | -           |

MC = SuperCut-Schere / SuperCut scissors  
TC = Hartmetallschere / hard metal scissors

CC = Keramikbeschichtete Schere / Ceramic coated scissors  
W = Wellenschliff-Schere / Wavecut scissors



spitz, gebogen  
pointed, curved



geknöpft, gebogen  
probe pointed, curved

20 cm - 8"

ER 2496-22

ER 2497-22



STRULLY

mit Führungsschiene  
with stabilising bar



125°

|            |             |
|------------|-------------|
| Typ / Type | 18 cm - 7"  |
|            | ER 1765-19  |
| MC         | ER 1765-19M |



HEGEMANN-DIETRICH



25°



45°



60°



90°



125°

Schneide, mit Knopf, spitz, gewinkelt  
Blade, with button, sharp, angled

|            |            |            |            |            |            |
|------------|------------|------------|------------|------------|------------|
|            | 18 cm - 7" |            | 18 cm - 7" |            | 18 cm - 7" |
| ER 1770-25 | ER 1770-45 | ER 1770-60 | ER 1770-90 | ER 1770-99 |            |

Schneide, ohne Knopf, spitz, gewinkelt  
Blade, without button, sharp, angled

|            |            |            |            |            |            |
|------------|------------|------------|------------|------------|------------|
| Typ / Type | 18 cm - 7" |            | 18 cm - 7" | 18 cm - 7" |            |
|            | ER 1771-25 | ER 1771-45 | ER 1771-60 | ER 1771-90 | ER 1771-99 |



MC = SuperCut-Schere / SuperCut scissors  
TC = Hartmetallschere / hard metal scissors

CC = Keramikbeschichtete Schere / Ceramic coated scissors  
W = Wellenschliff-Schere / Wavecut scissors

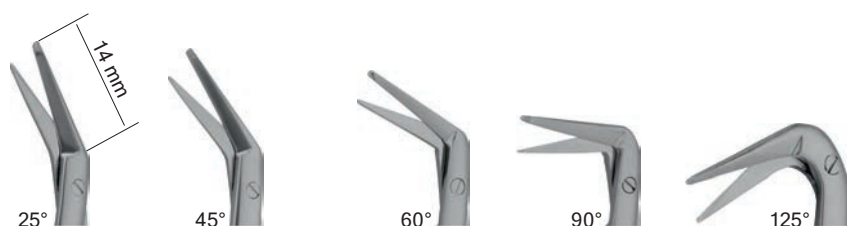

Schneide, mit Knopf, spitz, gewinkelt  
Blade, with button, sharp, angled

|               |            |               |               |            |
|---------------|------------|---------------|---------------|------------|
| 16,5 cm - 6½" |            | 16,5 cm - 6½" | 16,5 cm - 6½" |            |
| ER 1772-25    | ER 1772-45 | ER 1772-60    | ER 1772-90    | ER 1772-99 |



Schneide, ohne Knopf, spitz, gewinkelt  
Blade, without button, sharp, angled

|               |            |               |               |            |
|---------------|------------|---------------|---------------|------------|
| 16,5 cm - 6½" |            | 16,5 cm - 6½" | 16,5 cm - 6½" |            |
| ER 1773-25    | ER 1773-45 | ER 1773-60    | ER 1773-90    | ER 1773-99 |





Arteriotomie Schere  
Arteriotomy scissors



gebogen  
curved

17,5 cm - 7"

ER 1819-17



TÖNNIS-ADSON FINO



gerade  
straight



gebogen  
curved

18 cm - 7"

ER 1820-18

ER 1821-18



TÖNNIS

stumpf / stumpf  
blunt / blunt



gebogen  
curved

18 cm - 7"

ER 1810-18



BÖTTCHER



gebogen  
curved

Typ / Type 17,5 cm - 7"

ER 1825-17

MC ER 1825-17M

TC ER 1829-17

TC/W ER 1829-17W



TÖNNIS-ADSON

MC = SuperCut-Schere / SuperCut scissors  
TC = Hartmetallschere / hard metal scissors

CC = Keramikbeschichtete Schere / Ceramic coated scissors  
W = Wellenschliff-Schere / Wavecut scissors



Tonsillen-Scheren  
Tonsil Scissors



GOOD



gebogen  
curved

19 cm - 7½"

ER 1845-19

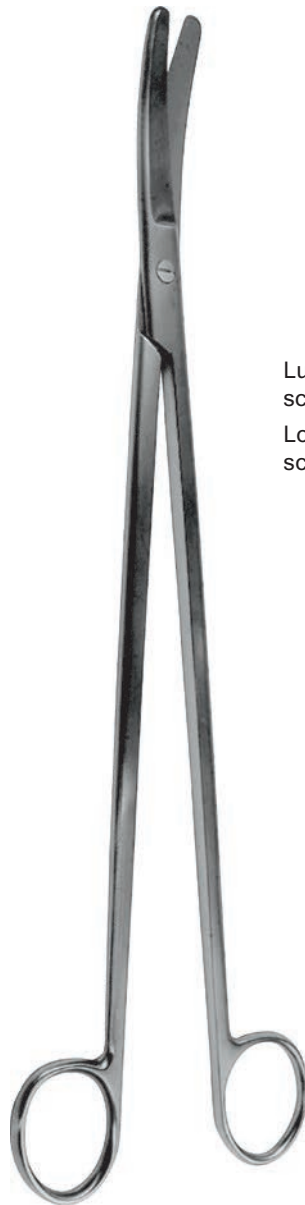

CRAFOORD

Lungenlappen-  
schere  
Lobectomy  
scissors



gebogen  
curved

31,5 cm - 12½"

ER 1860-30

MC = SuperCut-Schere / SuperCut scissors  
TC = Hartmetallschere / hard metal scissors

CC = Keramikbeschichtete Schere / Ceramic coated scissors  
W = Wellenschliff-Schere / Wavecut scissors



gerade  
straight

21 cm - 8 1/4"  
ER 1905-21



gerade  
straight

21 cm - 8 1/4"  
ER 1910-21

MC = SuperCut-Schere / SuperCut scissors  
TC = Hartmetallschere / hard metal scissors

CC = Keramikbeschichtete Schere / Ceramic coated scissors  
W = Wellenschliff-Schere / Wavecut scissors

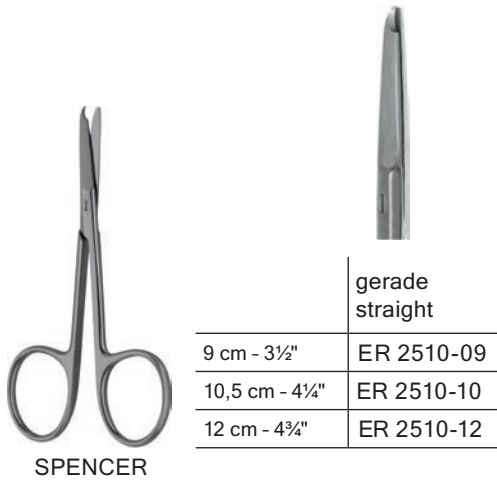

MC = SuperCut-Schere / SuperCut scissors  
TC = Hartmetallschere / hard metal scissors

CC = Keramikbeschichtete Schere / Ceramic coated scissors  
W = Wellenschliff-Schere / Wavecut scissors



stumpf / stumpf  
blunt / blunt

spitz / stumpf  
sharp / blunt

|            | Typ<br>Type | gerade<br>straight | gebogen<br>curved | gerade<br>straight | gebogen<br>curved |
|------------|-------------|--------------------|-------------------|--------------------|-------------------|
| 20 cm - 8" |             | ER 1401-20         | ER 1411-20        | ER 1402-20         | ER 1412-20        |
|            | MC          | ER 1401-20M        | ER 1411-20M       | -                  | -                 |
| 23 cm - 9" |             | ER 1401-23         | ER 1411-23        | ER 1402-23         | ER 1412-23        |
|            | MC          | -                  | ER 1411-23M       | -                  | -                 |



SIMS



gebogen  
curved

|               |            |
|---------------|------------|
| 14,5 cm - 5¾" | ER 1415-14 |
| 19,5 cm - 7¾" | ER 1415-19 |
| 22,5 cm - 8¾" | ER 1415-22 |



WERTHEIM

MC = SuperCut-Schere / SuperCut scissors  
TC = Hartmetallschere / hard metal scissors



stumpf / stumpf  
blunt / blunt

|            | Typ<br>Type | gebogen<br>curved |
|------------|-------------|-------------------|
| 20 cm - 8" | TC          | ER 1414-20        |
| 23 cm - 9" | TC          | ER 1414-23        |



SIMS

CC = Keramikbeschichtete Schere / Ceramic coated scissors  
W = Wellenschliff-Schere / Wavecut scissors



## Gynäkologische Scheren Gynecological Scissors

Kephalotomie Schere  
Cephalotomy scissors



DUBOIS

1:3



gerade  
straight

gebogen  
curved

27 cm - 10½"

ER 1420-27

ER 1421-27



KELLY

Fistelschere  
Fistula scissors



gerade  
straight



gebogen  
curved



gerade  
straight



gebogen  
curved

| Typ / Type | 16 cm - 6¼" |             | 18 cm - 7" |            |
|------------|-------------|-------------|------------|------------|
|            | ER 1440-16  | ER 1441-16  | ER 1440-18 | ER 1441-18 |
| MC         | ER 1440-16M | ER 1441-16M | -          | -          |
| CC         | -           | ER 1441-16C | -          | -          |
| TC         | ER 1444-16  | ER 1445-16  | -          | -          |
| TC/MC      |             | ER 1445-16M | -          | -          |

MC = SuperCut-Schere / SuperCut scissors  
TC = Hartmetallschere / hard metal scissors

CC = Keramikbeschichtete Schere / Ceramic coated scissors  
W = Wellenschliff-Schere / Wavecut scissors



spitz / stumpf  
sharp / blunt

gerade  
straight



stumpf / stumpf  
blunt / blunt

gerade  
straight



gebogen  
curved

|             |            |            |            |
|-------------|------------|------------|------------|
| 16 cm - 6¼" | ER 1428-16 | ER 1430-16 | ER 1431-16 |
| 18 cm - 7"  | -          | ER 1430-18 | ER 1431-18 |



DOYEN



|            |             |
|------------|-------------|
| Typ / Type | 24 cm - 9½" |
|            | ER 1455-24  |
| MC         | ER 1455-24M |



SIEBOLD

Uterusschere  
Uterine scissors

S-gebogen  
S-curved

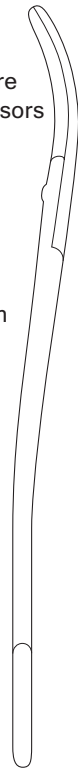

MC = SuperCut-Schere / SuperCut scissors  
TC = Hartmetallschere / hard metal scissors

CC = Keramikbeschichtete Schere / Ceramic coated scissors  
W = Wellenschliff-Schere / Wavecut scissors





BUSCH



gebogen  
curved

16 cm - 6¼"

ER 2000-16



SCHUMACHER

16 cm - 6¼"

ER 2010-16



MOD. USA

10,5 cm - 4¼"

ER 2020-10



kniegebogen  
curved bent

|            |             |             |
|------------|-------------|-------------|
| Typ / Type | 14 cm - 5½" | 22 cm - 8¾" |
|            | ER 2050-14  | ER 2055-22  |
| MC         | ER 2050-14M | ER 2055-22M |



BRAUN-STADLER



gezahnt  
serrated

|            |             |
|------------|-------------|
| Typ / Type | 18 cm - 7"  |
|            | ER 2085-18  |
| MC         | ER 2085-18M |



WALDMANN



gezahnt  
serrated

|            |             |
|------------|-------------|
| Typ / Type | 18 cm - 7"  |
|            | ER 2086-19  |
| MC         | ER 2086-19M |



MC = SuperCut-Schere / SuperCut scissors  
TC = Hartmetallschere / hard metal scissors



gezahnt  
serrated

|            |             |
|------------|-------------|
| Typ / Type | 19 cm - 7½" |
| TC         | ER 2087-19  |



CC = Keramikbeschichtete Schere / Ceramic coated scissors  
W = Wellenschliff-Schere / Wavecut scissors



gebogen  
curved

|    |                | Fig. 1     | Fig. 2     | Fig. 3     | Fig. 4     |
|----|----------------|------------|------------|------------|------------|
| TC | 23 cm - 9"     | ER 2090-11 | ER 2090-12 | ER 2090-13 | ER 2090-14 |
| TC | 26,5 cm - 10½" | ER 2090-21 | ER 2090-2  | ER 2090-23 | ER 2090-24 |

MC = SuperCut-Schere / SuperCut scissors  
TC = Hartmetallschere / hard metal scissors

CC = Keramikbeschichtete Schere / Ceramic coated scissors  
W = Wellenschliff-Schere / Wavecut scissors



spitz / spitz  
gerade  
sharp / sharp  
straight



spitz / spitz  
gebogen  
sharp / sharp  
curved

10,5 cm - 4 1/4"

ER 2870-10

ER 2871-10



BEEBEE



stumpf / stumpf  
gerade, gezahnt  
blunt / blunt  
straight, saw edge



stumpf / stumpf  
gebogen, gezahnt  
blunt / blunt  
curved, saw edge

12 cm - 4 3/4"

ER 2890-12

ER 2891-12

1 Blatt gezahnt  
1 blade serrated



BEEBEE



gezahnt  
saw edge

17 cm - 6¾"  
ER 2913-17

DEAN



gezahnt  
saw edge

gerade  
straight      gebogen  
curved

14,5 cm - 5¾"

ER 2920-14 | ER 2921-14

SULLIVAN

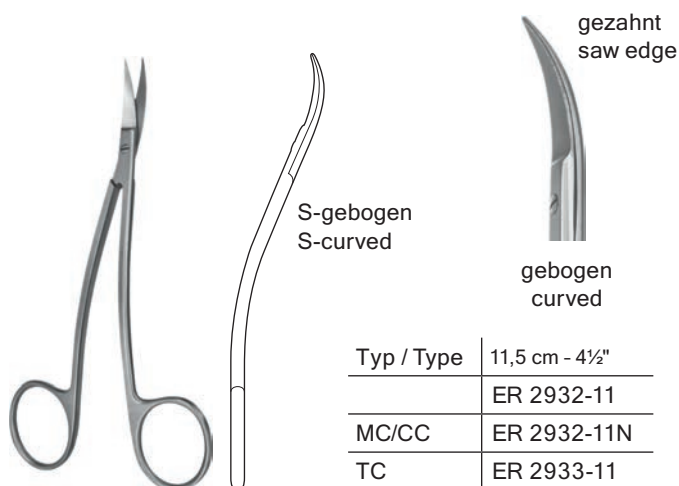

S-gebogen  
S-curved

gezahnt  
saw edge

gebogen  
curved

|            |               |
|------------|---------------|
| Typ / Type | 11,5 cm - 4½" |
|            | ER 2932-11    |
| MC/CC      | ER 2932-11N   |
| TC         | ER 2933-11    |

LA GRANGE



gezahnt  
saw edge

16,5 cm - 6½"

ER 2918-16

LOCKLIN

MC = SuperCut-Schere / SuperCut scissors  
TC = Hartmetallschere / hard metal scissors

CC = Keramikbeschichtete Schere / Ceramic coated scissors  
W = Wellenschliff-Schere / Wavecut scissors



Nagelspaltschere  
Nail splitting scissors



gerade  
straight

|            |            |             |
|------------|------------|-------------|
| Typ / Type | 13 cm - 5" | 15 cm - 6"  |
|            | ER 2620-1  | ER 2620-15  |
| W          | -          | ER 2620-15W |



Nagelscheren  
Nail scissors

gebogen  
curved

|  |               |            |
|--|---------------|------------|
|  | 9 cm - 3½"    | ER 2983-09 |
|  | 10,5 cm - 4¼" | ER 2983-10 |



## Draht-, Blehscheren Wire, Metal Cutting Scissors

Drahtschere  
Wire cutting scissors



gezahnt  
serrated

|            |              |
|------------|--------------|
| Typ / Type | 12,5 cm - 5" |
|            | ER 2600-12   |
| TC         | ER 2601-12   |



MC = SuperCut-Schere / SuperCut scissors  
TC = Hartmetallschere / hard metal scissors

CC = Keramikbeschichtete Schere / Ceramic coated scissors  
W = Wellenschliff-Schere / Wavecut scissors



|                  |               |
|------------------|---------------|
|                  | 14,5 cm - 5¾" |
| schwarz<br>black | ER 2602-14    |



|                  |            |
|------------------|------------|
|                  | 18 cm - 7" |
| schwarz<br>black | ER 2602-18 |



HARVEY



12,5 cm - 5"

ER 2610-12

stumpf / stumpf  
gezahnt  
blunt / blunt  
saw edge



LISTER

|               | Typ<br>Type | seitwärts abgewinkelt<br>angled to side |
|---------------|-------------|---|
| 9 cm - 3½"    |             | ER 2650-09                              |
| 11 cm - 4¼"   |             | ER 2650-11                              |
| 14,5 cm - 5¾" |             | ER 2650-14                              |
|               | MC          | ER 2650-14M                             |
| 15,5 cm - 6"  |             | ER 2650-15                              |
| 18 cm - 7"    |             | ER 2650-18                              |
|               | MC          | ER 2650-18M                             |
|               | TC          | ER 2651-18                              |
| 20 cm - 8"    |             | ER 2650-20                              |
|               | MC          | ER 2650-20M                             |

MC = SuperCut-Schere / SuperCut scissors  
TC = Hartmetallschere / hard metal scissors

CC = Keramikbeschichtete Schere / Ceramic coated scissors  
W = Wellenschliff-Schere / Wavecut scissors





seitwärts abgewinkelt  
angled sideways

|            |             |
|------------|-------------|
| Typ / Type | 21 cm - 8¼" |
|            | ER 2652-21  |
| MC         | ER 2652-21M |

LISTER

obere Schneide gezahnt,  
seitwärts abgewinkelt  
upper blade serrated,  
angled sideways



|             |            |
|-------------|------------|
| 16 cm - 6¼" | ER 2654-16 |
| 19 cm - 7½" | ER 2654-19 |

LISTER-EXCENTRIC



seitwärts abgewinkelt,  
gezahnt  
angled sideways,  
saw edge

|             |
|-------------|
| 17 cm - 6¾" |
| ER 2668-17  |

seitwärts abgewinkelt  
angled sideways

|            |            |            |
|------------|------------|------------|
| Typ / Type | 20 cm - 8" | 23 cm - 9" |
|            | ER 2655-20 | ER 2655-22 |
| TC         | ER 2656-20 | -          |



ESMARCH



seitwärts abgewinkelt  
angled sideways

---

23 cm - 9"

---

ER 2660-23

BERGMANN



gebogen  
curved

---

23 cm - 9"

---

ER 2665-23

LORENZ



BRUNS



glatt, gebogen  
smooth, curved



gezahnt, gebogen  
saw edge, curved

24 cm - 9½"

ER 2690-24

ER 2692-24

MC = SuperCut-Schere / SuperCut scissors  
TC = Hartmetallschere / hard metal scissors

CC = Keramikbeschichtete Schere / Ceramic coated scissors  
W = Wellenschliff-Schere / Wavecut scissors



glatt, gebogen  
smooth, curved

|            |             |
|------------|-------------|
| Typ / Type | 24 cm - 9½" |
| TC         | ER 2693-24  |



BRUNS

gerade  
straight

|            |
|------------|
| 18 cm - 7" |
| ER 2700-18 |



SMITH (MOD. USA)



geknöpft  
probe pointed

gerade  
straight

|             |
|-------------|
| 14 cm - 5½" |
| ER 2705-14  |



KNOWLES



geknöpft  
probe pointed

abgewinkelt  
angled

|             |
|-------------|
| 14 cm - 5½" |
| ER 2706-14  |



KNOWLES





kniegebogen  
gezahnt  
curved bent  
saw edge

mit Bügel  
with clamp

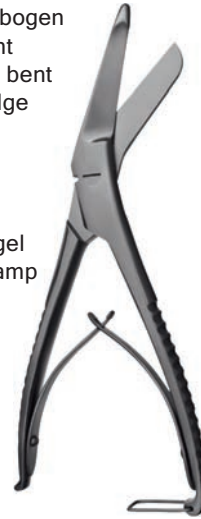

20 cm - 8"

ER 2710-20

1:3

kniegebogen  
gezahnt  
curved bent  
saw edge



23 cm - 9"

ER 2715-23

1:3

SEUTIN



Rippenschere  
Rib shear

COLLIN

22 cm - 8¾"

ER 2805-22



Rippenschere  
Rib shear

GLUCK

22 cm - 8¾"

ER 2820-22



## Pinzetten *Forceps*

**Mikro-Uhrmacher Pinzetten** / *Micro Jewelers Forceps*

**Mikro-Nahtpinzetten** / *Micro Suture Forceps*

**Anatomische Mikro-Pinzetten** / *Dissecting Micro Forceps*

**Mikro-Tumorfaßpinzetten** / *Micro Tumor Grasping Forceps*

**Mikro-Pinzetten, Rundgriff** / *Micro Forceps, Round Handle*

**Feine anatomische Pinzetten** / *Delicate Dissecting Forceps*

**Anatomische Pinzetten** / *Dissecting Forceps*

**Atrauma Pinzetten** / *Atrauma Forceps*

**Ohrpinzetten** / *Ear Dressing Forceps*

**Feine chirurgische Pinzetten** / *Delicate Tissue Forceps*

**Chirurgische Pinzetten** / *Tissue Forceps*

**Hautpinzetten** / *Skin Forceps*

**Darm- und Lungenpinzetten** / *Intestinal and Lung Forceps*

**Fasspinzetten** / *Grasping Forceps*

**Splitterpinzetten** / *Splinter Forceps*

**Cilienpinzetten** / *Cilia Forceps*





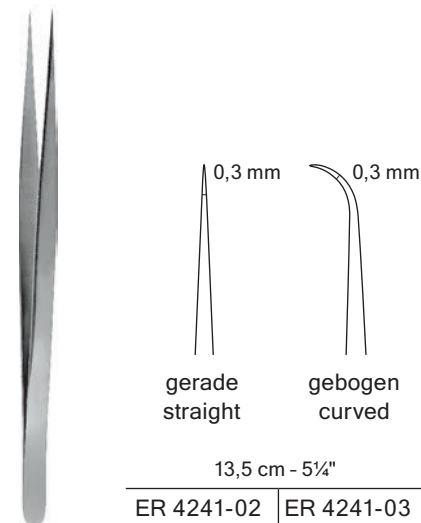
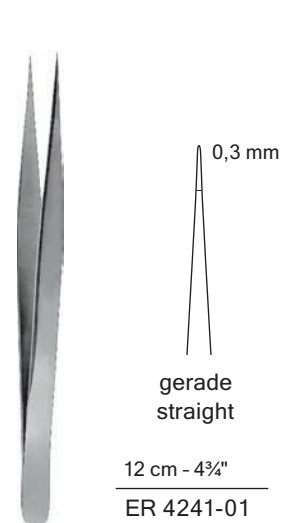
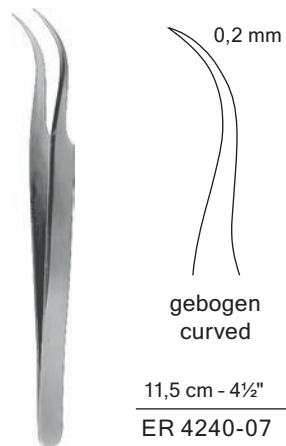
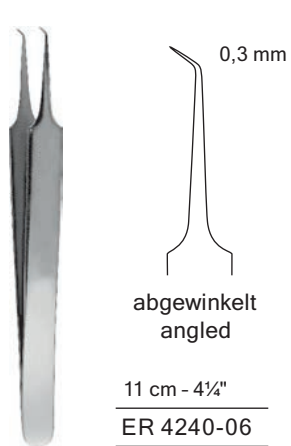
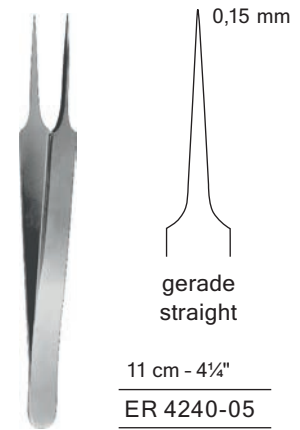
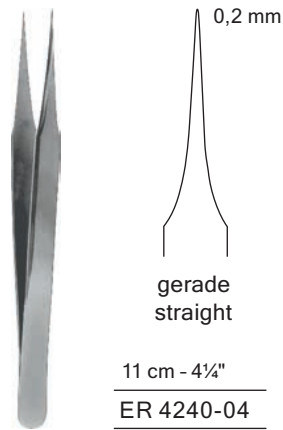
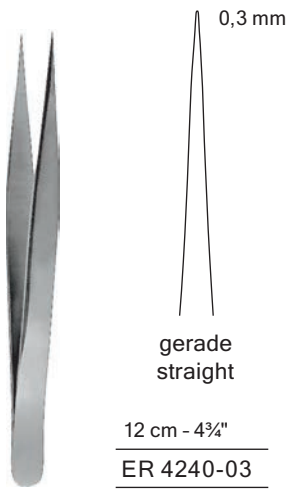

VISE

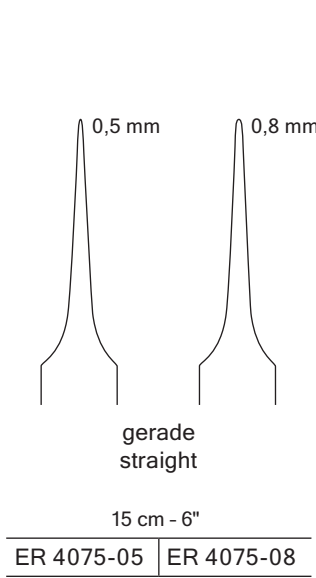
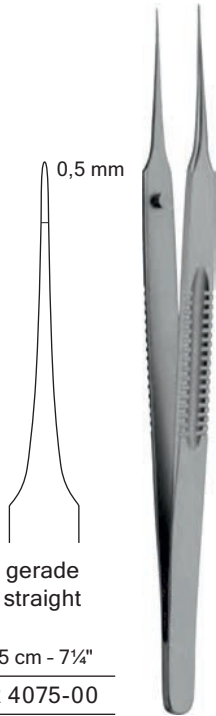

LAZAR

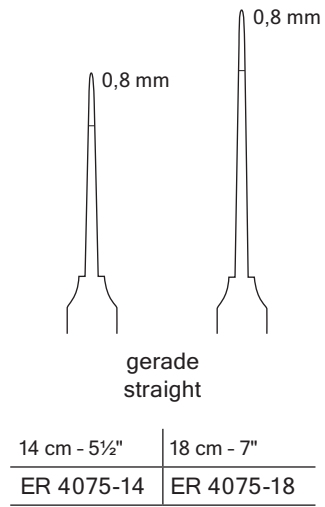

AUSTIN



ADSON



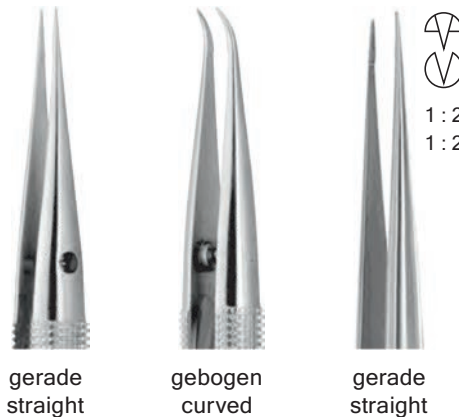

  
 1 : 2 Zähne  
 1 : 2 teeth



|             | Spitze<br>Tip | mit Fadenplatte, 7 mm<br>with tying platform, 7 mm |            |            |
|-------------|---------------|--|------------|------------|
| 12 cm - 4¾" | 0,3 mm        | ER 4068-12   | ER 4069-12 | -          |
| 15 cm - 6"  | 0,4 mm        | ER 4068-15   | ER 4069-15 | ER 4068-32 |
| 18 cm - 7"  | 0,4 mm        | ER 4068-18   | ER 4069-18 | ER 4068-42 |
|             | 0,7 mm        | ER 4068-19   | ER 4069-19 | ER 4068-44 |
| 21 cm - 8¼" | 0,7 mm        | ER 4068-21   | ER 4069-21 | ER 4068-46 |

gerade straight      gebogen curved      gerade straight

|             | Typ<br>Type | Spitze<br>Tip | mit Fadenplatte, 7 mm<br>with tying platform, 7 mm |             |
|-------------|-------------|---------------|--|-------------|
| 18 cm - 7"  | TI          | 0,4 mm        | ER 4068-18T  | ER 4069-18T |
|             | TI          | 0,8 mm        | ER 4068-19T  | ER 4069-19T |
| 21 cm - 8¼" | TI          | 0,8 mm        | ER 4068-22U  | ER 4069-22U |



0,6 mm  
 0,6 mm  
 0,6 mm  
  
 1 : 2 Zähne  
 1 : 2 teeth

|             | Typ<br>Type | Spitze<br>Tip | gerade<br>straight | gebogen<br>curved | gerade<br>straight |
|-------------|-------------|---------------|--------------------|-------------------|--------------------|
| 15 cm - 6"  | MG          | 0,6 mm        | ER 4068-51G        | ER 4068-52G       | ER 4068-63G        |
| 18 cm - 7"  | MG          | 0,6 mm        | ER 4068-53G        | ER 4068-54G       | -                  |
| 21 cm - 8¼" | MG          | 0,6 mm        | ER 4068-55G        | ER 4068-56G       | -                  |

MG = mit Gegengewicht / with counterweight

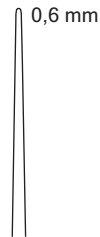

0,6 mm

glatt, gerade  
smooth, straight

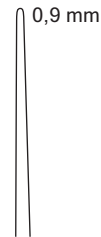

0,9 mm



1,2 mm

1 : 2 Zähne  
1 : 2 teeth

gerade  
straight



bajonettförmig  
bayonet-shaped

YASARGIL

|             |            |            |            |
|-------------|------------|------------|------------|
| 16 cm - 6¼" | ER 4063-22 | ER 4063-24 | -          |
| 18 cm - 7"  | ER 4063-32 | ER 4063-34 | ER 4063-36 |
| 20 cm - 8"  | ER 4063-42 | ER 4063-44 | -          |
| 22 cm - 8¾" | ER 4063-52 | ER 4063-54 | -          |
| 24 cm - 9½" | ER 4063-62 | ER 4063-64 | -          |



0,6 mm

glatt, gerade  
smooth, straight

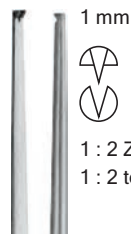

1 mm

gerade  
straight



1 : 2 Zähne  
1 : 2 teeth

bajonettförmig  
bayonet-shaped



0,7 mm

gerade  
straight





|             |            |
|-------------|------------|
| 16 cm - 6¼" |            |
| ER 4296-01  | ER 4296-02 |

|            |            |
|------------|------------|
| 15 cm - 6" | ER 4065-15 |
| 18 cm - 7" | ER 4065-18 |



leichter Lochgriff,  
bajonettförmig  
light perforated handle,  
bayonet-shaped

YASARGIL

|             |  Ø 3 mm |  Ø 5 mm |  Ø 7 mm |
|-------------|--|--|--|
| 22 cm - 8¾" | ER 4064-51   | ER 4064-52   | -  |
| 24 cm - 9½" | ER 4064-61   | ER 4064-62   | ER 4064-63   |

|             |  Ø 3 mm |  Ø 3 mm |
|-------------|--|--|
| 22 cm - 8¾" | ER 4064-54   | ER 4064-55   |

|             |  Ø 5 mm |  Ø 5 mm |
|-------------|--|--|
| 22 cm - 8¾" | ER 4064-57   | ER 4064-58   |

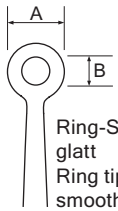

Ring-Spitze  
glatt  
Ring tip  
smooth



Ring-Spitze  
feingerieft  
Ring tip  
fine serrated

diamantiert / diamond coated

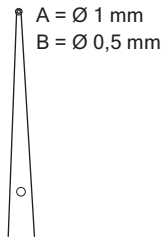

Typ  
Type  
feingerieft  
fine serrated

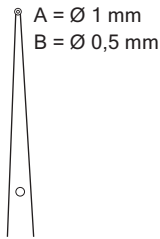

glatt  
smooth

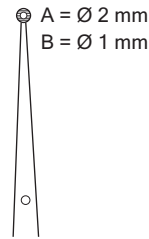

feingerieft  
fine serrated

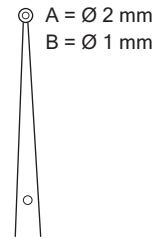

glatt  
smooth

|             |    |             |             |             |             |
|-------------|----|-------------|-------------|-------------|-------------|
| 15 cm - 6"  |    | ER 4079-12  | ER 4079-14  | -           | -           |
| 18 cm - 7"  |    | ER 4079-32  | ER 4079-34  | ER 4079-36  | ER 4079-38  |
| 18 cm - 7"  | TI | ER 4079-32T | ER 4079-34T | ER 4079-36T | ER 4079-38T |
| 22 cm - 8¾" |    | ER 4079-52  | ER 4079-54  | ER 4079-56  | ER 4079-58  |



diamantiert / diamond coated

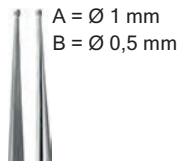

Typ  
Type  
gerade  
straight

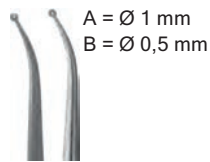

gebogen  
curved

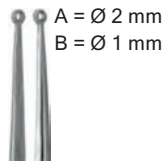

gerade  
straight

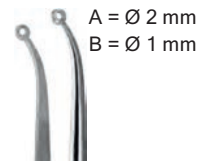

gebogen  
curved

|            |       |             |             |             |             |
|------------|-------|-------------|-------------|-------------|-------------|
| 15 cm - 6" | MG    | ER 4068-74G | ER 4068-75G | -           | -           |
| 15 cm - 6" | MG/TI |             | -           | ER 4079-16U | -           |
| 18 cm - 7" | MG    | ER 4079-32G | ER 4079-33G | ER 4079-36G | ER 4079-37G |

MG = mit Gegengewicht / with counterweight





glatt, gerade  
smooth, straight

|              |            |
|--------------|------------|
| 12 cm - 4¾"  | ER 4033-12 |
| 15,5 cm - 6" | ER 4033-15 |

JACOBSON-ADSON



gerade  
straight

gerade,  
kreuzgerieft  
straight,  
cross serrated

|             |            |            |
|-------------|------------|------------|
| 12 cm - 4¾" | ER 4035-12 | ER 4035-32 |
| 15 cm - 6"  | ER 4035-15 | -          |

ADSON STANDARD



gerade  
straight

|             |            |
|-------------|------------|
| 12 cm - 4¾" | ER 4034-12 |
| 15 cm - 6"  | ER 4034-15 |

MICRO ADSON



gerade  
straight

|             |            |
|-------------|------------|
| 12 cm - 4¾" | ER 4032-12 |
|-------------|------------|

EWALD



kreuzgerieft  
cross serrated



Typ  
Type

gerade  
straight

|             |    |            |
|-------------|----|------------|
| 12 cm - 4¾" | TC | ER 4036-12 |
| 15 cm - 6"  | TC | ER 4036-15 |

ADSON





DE BAKEY Zahnung  
DE BAKEY Serration



gerade  
straight

|              |            |
|--------------|------------|
| 12,5 cm - 5" | ER 7585-12 |
| 15 cm - 6"   | ER 7585-15 |

ADSON

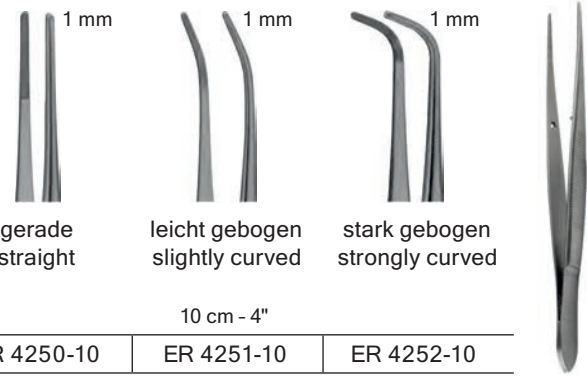

gerade  
straight

leicht gebogen  
slightly curved

stark gebogen  
strongly curved

10 cm - 4"

|            |            |            |
|------------|------------|------------|
| ER 4250-10 | ER 4251-10 | ER 4252-10 |
|------------|------------|------------|

GRAEFE

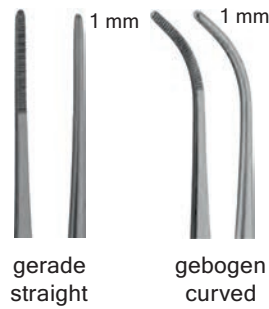

gerade  
straight

gebogen  
curved

|              |            |            |
|--------------|------------|------------|
| 12,5 cm - 5" | ER 4040-12 | ER 4041-12 |
| 15 cm - 6"   | ER 4040-15 | ER 4041-15 |

SEMKEN

kreuzgerieft  
cross serrated



gerade  
straight

|            |            |
|------------|------------|
| Typ / Type | 15 cm - 6" |
| TC         | ER 4042-15 |

SEMKEN

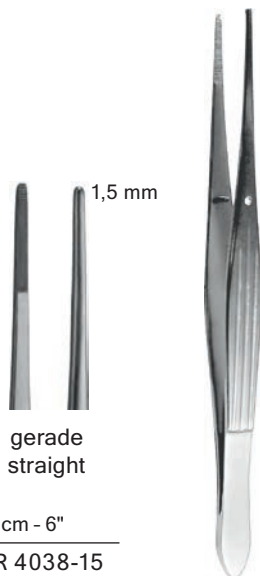

gerade  
straight

|            |
|------------|
| 15 cm - 6" |
| ER 4038-15 |

MC INDOE

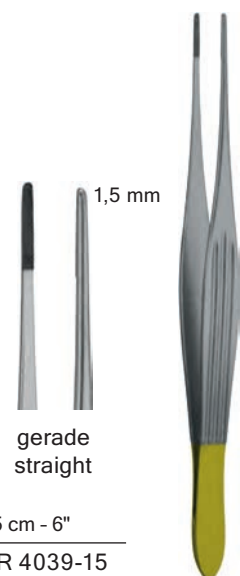

gerade  
straight

|            |            |
|------------|------------|
| Typ / Type | 15 cm - 6" |
| TC         | ER 4039-15 |

MC INDOE

# Pinzetten | Forceps

Feine anatomische Pinzetten  
Delicate Dissecting Forceps



Ermis®



kreuzgerieft  
cross serrated





1 mm

gerade  
straight

|            |              |
|------------|--------------|
| Typ / Type | 17,5 cm - 7" |
| TC         | ER 4070-57   |

GERALD

1 mm

gerade  
straight

|            |            |
|------------|------------|
| 15 cm - 6" | ER 4055-15 |
| 18 cm - 7" | ER 4055-18 |
| 21 cm - 8" | ER 4055-20 |

WAUGH



bajonettförmig  
bayonet-shaped





1 mm

gerade  
straight

|             |
|-------------|
| 19 cm - 7½" |
| ER 4071-59  |

GERALD

1 mm

gerade  
straight



1 mm

gebogen  
curved

|              |            |
|--------------|------------|
| 17,5 cm - 7" |            |
| Typ / Type   | ER 4070-17 |
|              | ER 4071-17 |

GERALD



gerade  
straight

gebogen  
curved

17,5 cm - 7"

ER 4050-17

ER 4051-17



TAYLOR



gerade  
straight

17,5 cm - 7"

ER 4052-17



TAYLOR



gerade  
straight

bajonettförmig  
bayonet-shaped



CUSHING-TAYLOR

bajonettförmig  
bayonet-shaped

1,5 mm

gerade  
straight



TAYLOR

|            |            |
|------------|------------|
| Typ / Type | 18 cm - 7" |
| TC         | ER 4083-17 |

|               |            |
|---------------|------------|
| 18,5 cm - 7¼" | ER 4054-17 |
| 19,5 cm - 7¾" | ER 4054-20 |



CUSHING



gerade  
straight



gebogen  
curved

18 cm - 7"

ER 4080-17

ER 4081-17



CUSHING



gerade  
straight



gebogen  
curved

Typ / Type

18 cm - 7"

TC

ER 4082-17

ER 4082-27



BROPHY



gerade  
straight



gebogen  
curved

20 cm - 8"

ER 4060-20

ER 4061-20



gerade  
straight

|            |             |
|------------|-------------|
| Typ / Type | 19 cm - 7½" |
| TC         | ER 4084-18  |



bajonettförmig  
bayonet-shaped

GRÜN WALD



gerade  
straight

|            |            |
|------------|------------|
| Typ / Type | 20 cm - 8" |
| TC         | ER 4058-20 |



gerade  
straight



gebogen  
curved

|             |            |            |
|-------------|------------|------------|
| 18 cm - 7"  | ER 4090-18 | ER 4091-18 |
| 21 cm - 8¼" | ER 4090-21 | ER 4091-21 |
| 25 cm - 10" | ER 4090-25 | ER 4091-25 |



POTTS-SMITH



Typ  
Type gerade  
straight

|             |    |            |
|-------------|----|------------|
| 15 cm - 6"  | TC | ER 4092-15 |
| 18 cm - 7"  | TC | ER 4092-18 |
| 20 cm - 8"  | TC | ER 4092-20 |
| 23 cm - 9"  | TC | ER 4092-23 |
| 25 cm - 10" | TC | ER 4092-25 |



POTTS-SMITH



Standard



gerade  
straight



gebogen  
curved



mittelbreit, gerade  
medium, straight



mittelbreit, gebogen  
medium, curved

|               |            |            |            |            |
|---------------|------------|------------|------------|------------|
| 10,5 cm - 4¼" | ER 4000-10 | -          | -          | -          |
| 11,5 cm - 4½" | ER 4000-11 | ER 4001-11 | ER 4010-11 | ER 4011-11 |
| 13 cm - 5"    | ER 4000-13 | ER 4001-13 | ER 4010-13 | ER 4011-13 |
| 14,5 cm - 5¾" | ER 4000-14 | ER 4001-14 | ER 4010-14 | ER 4011-14 |
| 15 cm - 6"    | ER 4000-15 | -          | -          | -          |
| 16 cm - 6 ¼"  | ER 4000-16 | ER 4001-16 | ER 4010-16 | ER 4011-16 |
| 18 cm - 7"    | ER 4000-18 | ER 4001-18 | ER 4010-18 | ER 4011-18 |
| 20 cm - 8"    | ER 4000-20 | ER 4001-20 | ER 4010-20 | ER 4011-20 |
| 25 cm - 10"   | ER 4000-25 | ER 4001-25 | ER 4010-25 | ER 4011-25 |
| 30 cm - 11¾"  | ER 4000-30 | ER 4001-30 | ER 4010-30 | ER 4011-30 |



Standard



Typ  
Type gerade  
straight

|               |    |            |
|---------------|----|------------|
| 14,5 cm - 5¾" | TC | ER 4002-14 |
| 16 cm - 6 ¼"  | TC | ER 4002-16 |
| 18 cm - 7"    | TC | ER 4002-18 |
| 20 cm - 8"    | TC | ER 4002-20 |
| 25 cm - 10"   | TC | ER 4002-25 |



Schwedisches Modell  
Swedish pattern



gerade  
straight

|             |            |
|-------------|------------|
| 13 cm - 5"  | ER 4013-13 |
| 15 cm - 6"  | ER 4013-15 |
| 17 cm - 6¾" | ER 4013-17 |
| 20 cm - 8"  | ER 4013-20 |

STILLE



schmal, gerade  
narrow, straight

|               |            |
|---------------|------------|
| 11,5 cm - 4½" | ER 4015-11 |
| 13 cm - 5"    | ER 4015-13 |
| 14,5 cm - 5¾" | ER 4015-14 |
| 16 cm - 6"    | ER 4015-16 |
| 18 cm - 7¼"   | ER 4015-18 |
| 20 cm - 8"    | ER 4015-20 |



3,5 mm

gerade  
straight



2 mm

mittelbreit, gerade  
medium, straight

|               |            |            |
|---------------|------------|------------|
| 12 cm - 4¾"   | ER 4020-12 | ER 4022-12 |
| 13 cm - 5"    | ER 4020-13 | ER 4022-13 |
| 14,5 cm - 5¾" | ER 4020-14 | ER 4022-14 |
| 15 cm - 6"    | ER 4020-15 | ER 4022-15 |
| 18 cm - 7"    | ER 4020-18 | -          |
| 21 cm - 8¼"   | ER 4020-21 | -          |
| 25 cm - 10"   | ER 4020-25 | -          |
| 31 cm - 11¾"  | ER 4020-30 | -          |



MODELL USA



gerade  
straight

23 cm - 9"

ER 4086-23



Typ  
Type



gerade  
straight

|             |    |            |
|-------------|----|------------|
| 15 cm - 6"  | TC | ER 4085-15 |
| 23 cm - 9"  | TC | ER 4085-23 |
| 25 cm - 10" | TC | ER 4085-25 |



WANGENSTEEN



gerade  
straight

18 cm - 7"

ER 4059-18



BONNEY





DE BAKEY Zahnung  
DE BAKEY Serration

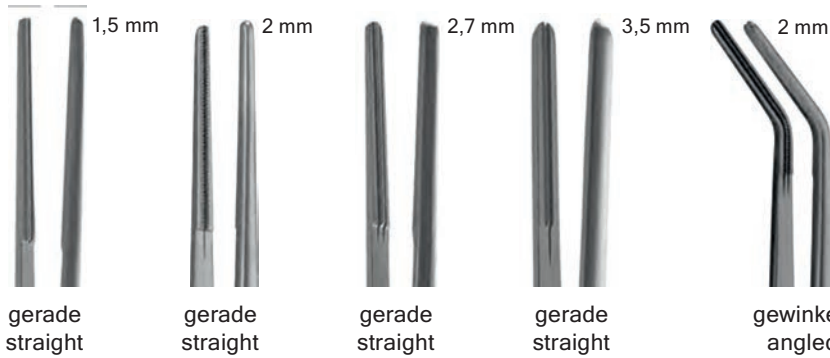

|              |            |            |            |            |            |
|--------------|------------|------------|------------|------------|------------|
| 15 cm - 6"   | ER 7580-16 | ER 7581-16 | ER 7582-16 | ER 7583-16 | ER 7584-16 |
| 20 cm - 8"   | ER 7580-20 | ER 7581-20 | ER 7582-20 | ER 7583-20 | ER 7584-20 |
| 24 cm - 9½"  | ER 7580-24 | ER 7581-24 | ER 7582-24 | ER 7583-24 | ER 7584-24 |
| 30 cm - 11¼" | ER 7580-30 | ER 7581-30 | ER 7582-30 | ER 7583-30 | ER 7584-30 |



DE BAKEY



1 : 2 Zähne  
1 : 2 teeth

|      |             |
|------|-------------|
|      | 14 cm - 5½" |
| 1 mm | ER 7863-14  |



bajonettförmig  
bayonet-shaped

LUCAE



gerade, gezahnt,  
gerieft  
straight, toothed,  
serrated

|  |             |
|--|-------------|
|  | 16 cm - 6¼" |
|  | ER 7863-15  |



Fixierpinzette  
Fixing forceps

bajonettförmig  
bayonet-shaped

COTTLE



bajonettförmig  
bayonet-shaped

|               |            |
|---------------|------------|
| 16 cm - 6¼"   | ER 7864-16 |
| 19,5 cm - 7¾" | ER 7864-18 |
| 21 cm - 8¼"   | ER 7864-20 |



JANSEN-GRUENWALD



bajonettförmig  
bayonet-shaped

|             |            |
|-------------|------------|
| 16 cm - 6¼" | ER 7865-16 |
| 19 cm - 8"  | ER 7865-20 |



1 : 2 Zähne  
1 : 2 teeth

JANSEN

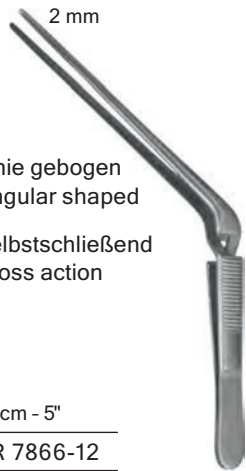

2 mm

Knie gebogen  
angular shaped

selbstschließend  
cross action

13 cm - 5"  
ER 7866-12

TROELTSCH

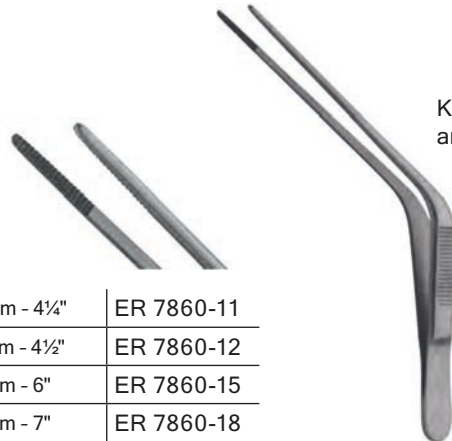

Knie gebogen  
angular shaped

|             |            |
|-------------|------------|
| 11 cm - 4¼" | ER 7860-11 |
| 13 cm - 4½" | ER 7860-12 |
| 15 cm - 6"  | ER 7860-15 |
| 17 cm - 7"  | ER 7860-18 |

TROELTSCH (WILDE)



Knie gebogen  
angular shaped





1 : 2 Zähne  
1 : 2 teeth





12 cm - 4¾"  
ER 7861-12

TROELTSCH

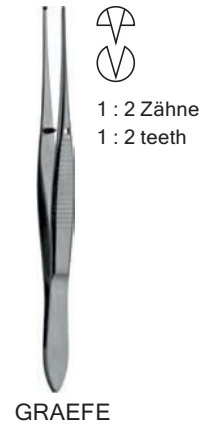



|   |   |   |
|---|---|---|
|  |  |  |
| gerade<br>straight  | leicht gebogen<br>slightly curved   | stark gebogen<br>strongly curved  |
| sehr fein<br>very delicate  | sehr fein<br>very delicate  | sehr fein<br>very delicate  |
| 10 cm - 4"  |   |   |
| ER 4260-10  | ER 4261-10  | ER 4262-10  |



|  |  |   |  |
|--|--|---|--|
|  |  |  |  |
| 1,2 mm   | 0,8 mm   | 1,2 mm  | 0,8 mm   |
| gerade, kreuzgerieft<br>straight, cross serrated                                   |  | gerade<br>straight  |  |
| 12 cm - 4 3/4"   |  |   |  |
| ER 4133-01   | ER 4133-02   | ER 4133-03  | ER 4133-04   |



|  |   |            |
|--|---|------------|
|  |  | 1 mm       |
| gerade<br>straight   |   |            |
| Typ<br>Type  | TC  |            |
| 12 cm - 4 3/4"   | ER 41 28-12   | ER 4130-22 |
| 15 cm - 6"   | ER 41 28-15   | ER 4130-25 |





kreuzgerieft  
cross serrated



1 : 2 Zähne  
1 : 2 teeth



12 cm - 4¾"

ER 4136-12

ADSON



1 : 2 Zähne  
1 : 2 teeth



Typ  
Type gerade  
straight

12 cm - 4¾"

TC ER 4134-12

15 cm - 6"

TC ER 4134-15

STANDARD ADSON



STANDARD ADSON



1 : 2 Zähne  
1 : 2 teeth

12 cm - 4¾"

ER 4135-12

15 cm - 6"

ER 4135-15



2 : 3 Zähne  
2 : 3 teeth

ER 4135-52

ER 4135-55



1 : 2 Zähne  
1 : 2 teeth



ADSON-EWALD



12 cm - 4¾"

ER 4132-12



1 : 2 Zähne  
1 : 2 teeth



MICRO-SEMKEN



1 mm

Typ  
Type gerade  
straight

14,5 cm - 5"

TC ER 4140-24



1 : 2 Zähne  
1 : 2 teeth



0,6 mm

gerade  
straight

ER 4147-01



0,8 mm

gerade  
straight

ER 4147-02



1 mm

gerade  
straight

ER 4147-03

15 cm - 6"



1 : 2 Zähne  
1 : 2 teeth

1,5 mm



gerade  
straight

15 cm - 6"

ER 4138-75



MC INDOE



1,5 mm



1 : 2 Zähne  
1 : 2 teeth

SEMKEN

12,5 cm - 5"

ER 4140-12

15 cm - 6"

ER 4140-15



1,5 mm



1 : 2 Zähne  
1 : 2 teeth

SEMKEN

ER 4141-12

ER 4141-15



2 mm



2 : 3 Zähne  
2 : 3 teeth

MICRO-  
SEMKEN

ER 4142-12



1 : 2 Zähne  
1 : 2 teeth

1,5 mm



gerade  
straight

Typ / Type

15,5 cm - 6"

ER 4138-15



GILLIES



1 : 2 Zähne  
1 : 2 teeth

1,5 mm



gerade  
straight

Typ / Type

15,5 cm - 6"

TC

ER 4138-65



GILLIES





1 : 2 Zähne  
1 : 2 teeth

gerade  
straight

| Typ<br>Type   | gerade<br>straight |
|---------------|--------------------|
| 14,5 cm - 5¾" | TC ER 4101-14      |
| 16 cm - 6 ¼"  | TC ER 4101-16      |
| 18 cm - 7"    | TC ER 4101-18      |
| 20 cm - 8"    | TC ER 4101-20      |
| 25 cm - 10"   | TC ER 4101-25      |
| 30 cm - 11¾"  | TC ER 4101-30      |

OEHLER



1 : 2 Zähne  
1 : 2 teeth

1,5 mm

gerade  
straight

|              |            |
|--------------|------------|
| 15 cm - 6"   | ER 4155-15 |
| 18 cm - 7"   | ER 4155-18 |
| 21 cm - 8"   | ER 4155-20 |
| 25 cm - 10"  | ER 4155-25 |
| 30 cm - 11¾" | ER 4155-30 |

WAUGH



1 : 2 Zähne  
1 : 2 teeth

1,5 mm

gerade  
straight

gebogen  
curved

|             |            |            |
|-------------|------------|------------|
| 18 cm - 7"  | ER 4190-18 | ER 4191-18 |
| 21 cm - 8¼" | ER 4190-21 | ER 4191-21 |
| 25 cm - 10" | ER 4190-25 | ER 4191-25 |

POTTS-SMITH



1 : 2 Zähne  
1 : 2 teeth

1,8 mm

gerade  
straight

gebogen  
curved

|            |            |            |
|------------|------------|------------|
| 18 cm - 7" | ER 4180-17 | ER 4181-17 |
|------------|------------|------------|

CUSHING





1 : 2 Zähne  
1 : 2 teeth



gerade  
straight

gebogen  
curved

20 cm - 8"

ER 4160-20

ER 4161-20



BROPHY



1 : 2 Zähne  
1 : 2 teeth



gerade  
straight

gebogen  
curved

17,5 cm - 7"

ER 4170-18

ER 4171-18



GERALD



1 : 2 Zähne  
1 : 2 teeth



gerade  
straight

gebogen  
curved

17,5 cm - 7"

ER 4150-17

ER 4151-17



TAYLOR



1 : 2 Zähne  
1 : 2 teeth

bajonettförmig  
bayonet-shaped



gerade  
straight

19 cm - 7½"

ER 4171-59



GERALD

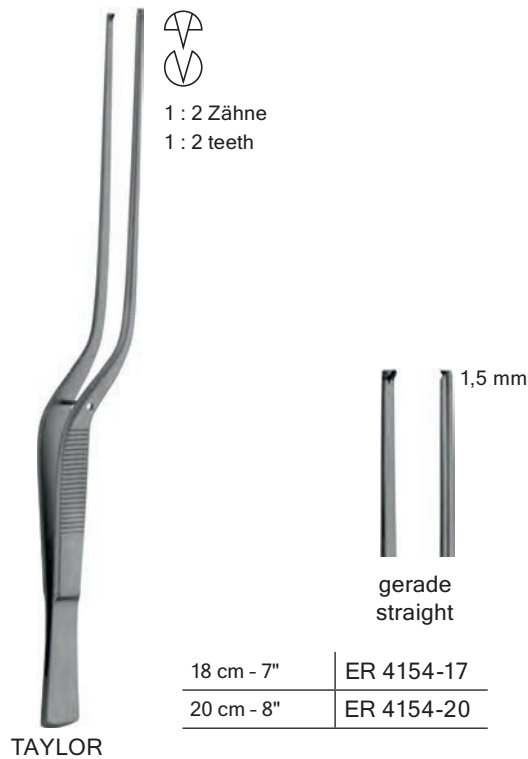
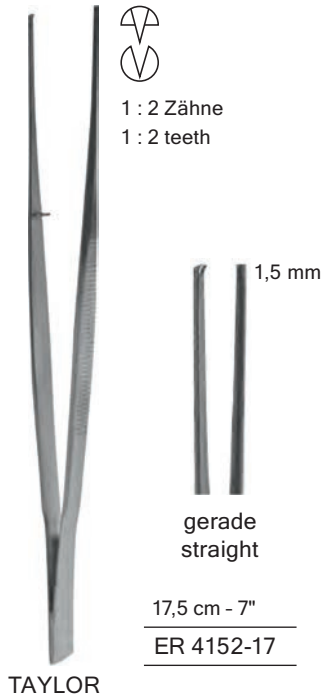



gerade  
straight

|               |            |
|---------------|------------|
| 10,5 cm - 4¼" | ER 4100-10 |
| 11,5 cm - 4½" | ER 4100-11 |
| 13 cm - 5"    | ER 4100-13 |
| 14,5 cm - 5¾" | ER 4100-14 |
| 15,5 cm - 6"  | ER 4100-15 |
| 16 cm - 6 ¼"  | ER 4100-16 |
| 18 cm - 7"    | ER 4100-18 |
| 20 cm - 8"    | ER 4100-20 |
| 25 cm - 10"   | ER 4100-25 |
| 30 cm - 11¾"  | ER 4100-30 |



1 : 2 Zähne  
1 : 2 teeth

Standard Modell  
Standard pattern



schmal  
narrow

|               |            |
|---------------|------------|
| 11,5 cm - 4½" | ER 4110-11 |
| 13 cm - 5"    | ER 4110-13 |
| 14,5 cm - 5¾" | ER 4110-14 |
| 16 cm - 6"    | ER 4110-16 |
| 18 cm - 7¼"   | ER 4110-18 |
| 20 cm - 8"    | ER 4110-20 |
| 25 cm - 10"   | ER 4110-25 |



1 : 2 Zähne  
1 : 2 teeth



gerade  
straight

3 mm



2 : 3 Zähne  
2 : 3 teeth



gerade  
straight

4,5 mm



3 : 4 Zähne  
3 : 4 teeth



gerade  
straight

6 mm



4 : 5 Zähne  
4 : 5 teeth

|               |            |            |            |
|---------------|------------|------------|------------|
| 11,5 cm - 4½" | -          | ER 4103-13 | -          |
| 13 cm - 5"    | ER 4102-13 | ER 4103-14 |            |
| 14,5 cm - 5¾" | ER 4102-14 | -          | ER 4104-14 |
| 15,5 cm - 6"  | -          | ER 4103-16 | -          |
| 16 cm - 6 ¼"  | ER 4102-16 | -          |            |
| 18 cm - 7"    | ER 4102-18 | -          | -          |
| 20 cm - 8"    | ER 4102-20 | ER 4103-20 | -          |
| 25 cm - 10"   | ER 4102-25 | -          | -          |
| 30 cm - 11¾"  | ER 4102-30 | -          | -          |



Standard Modell  
Standard pattern



MODELL USA



gerade  
straight

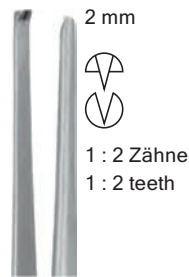

schmal, gerade  
narrow, straight

|               |            |            |
|---------------|------------|------------|
| 12 cm - 4¾"   | ER 4120-12 | -          |
| 13 cm - 5"    | ER 4120-13 | ER 4126-13 |
| 14,5 cm - 5¾" | ER 4120-14 | ER 4126-14 |
| 15,5 cm - 6"  | ER 4120-15 | ER 4126-15 |
| 18 cm - 7"    | ER 4120-18 | -          |
| 21 cm - 8¼"   | ER 4120-21 | -          |
| 25 cm - 10"   | ER 4120-25 | -          |
| 31 cm - 12¼"  | ER 4120-31 | -          |



FERRIS-SMITH



gerade  
straight

|            |            |
|------------|------------|
| Typ / Type | 18 cm - 7" |
| TC         | ER 4225-52 |



FERRIS-SMITH



gerade  
straight



gerade  
straight

|            |            |
|------------|------------|
| 18 cm - 7" |            |
| ER 4225-18 | ER 4225-28 |



4 mm



1 : 2 Zähne  
1 : 2 teeth

gerade  
straight



4,5 mm



2 : 3 Zähne  
2 : 3 teeth

gerade  
straight

14,5 cm - 5¾"

ER 4226-14

ER 4227-14

20 cm - 8"

ER 4226-20

ER 4227-20



LANE

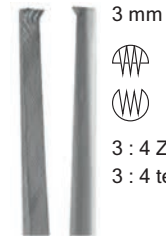

3 mm



3 : 4 Zähne  
3 : 4 teeth

gerade,  
kreuzgerieft  
straight,  
cross serrated

18 cm - 7"

ER 4228-18

20 cm - 8"

ER 4228-20

25 cm - 10"

ER 4228-25



STILLE-BARRAYA



4 mm



1 : 2 Zähne  
1 : 2 teeth



4 mm



2 : 3 Zähne  
2 : 3 teeth

17 cm - 6¾"

ER 4229-18

ER 4230-18



BONNEY

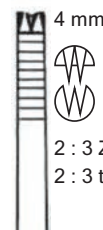

4 mm



2 : 3 Zähne  
2 : 3 teeth

gerade  
straight

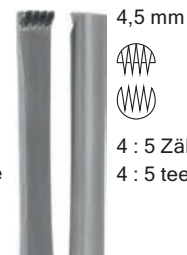

4,5 mm



4 : 5 Zähne  
4 : 5 teeth

gerade  
straight

15 cm - 6"

ER 4144-15

ER 4145-15

20 cm - 8"

ER 4144-20

ER 4145-20

25 cm - 10"

ER 4144-25

ER 4145-25



ADLERKREUTZ



ADSON-BROWN

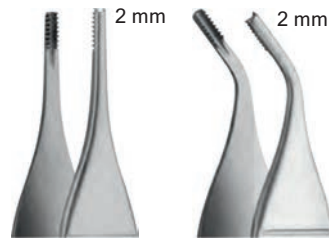

gerade  
straight

gebogen  
curved

|             |            |            |
|-------------|------------|------------|
| 12 cm - 4¾" | ER 4137-12 |            |
| 15 cm - 6"  | ER 4137-15 | ER 4137-72 |



ADSON-BROWN



gerade  
straight

|            |             |
|------------|-------------|
| Typ / Type | 12 cm - 4¾" |
| TC         | ER 4137-62  |



BROWN



gerade  
straight

|             |            |
|-------------|------------|
| 15 cm - 6"  | ER 4139-15 |
| 20 cm - 6"  | ER 4139-20 |
| 25 cm - 10" | ER 4139-25 |



ADSON-GRAEFE



gerade  
straight

|             |
|-------------|
| 12 cm - 4¾" |
| ER 4137-82  |

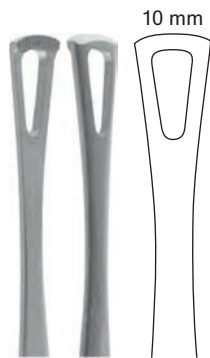

gerade  
straight

14,5 cm - 5 7/8"  
ER 4215-14



DUVAL



gerade  
straight

20 cm - 8"  
ER 4216-20



COLLIN-DUVAL

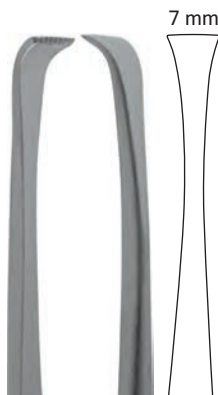

gerade  
straight

15 cm - 6" | ER 4235-15  
18 cm - 7" | ER 4235-18  
23 cm - 9" | ER 4235-23



NELSON



gerade  
straight

18 cm - 7" | ER 4236-18  
23 cm - 9" | ER 4236-23



SINGLEY-TUTTLE





RUSS. MODELL



gerade  
straight

|             |            |
|-------------|------------|
| 15 cm - 6"  | ER 4220-15 |
| 20 cm - 8"  | ER 4220-20 |
| 25 cm - 10" | ER 4220-25 |



MAYO



gerade  
straight

|            |            |
|------------|------------|
| 23 cm - 9" | ER 4221-23 |
|------------|------------|



DURANTE



gerade  
straight

|               |            |
|---------------|------------|
| 14,5 cm - 5¾" | ER 4219-14 |
| 16 cm - 6¼"   | ER 4219-16 |
| 20 cm - 8"    | ER 4219-20 |



gerade, glatt  
straight, smooth



gebogen, glatt  
curved, smooth



gerade  
straight



gebogen  
curved

|               |            |            |            |            |
|---------------|------------|------------|------------|------------|
| 8 cm - 3¼"    | ER 4290-08 | ER 4291-08 | ER 4292-08 | ER 4293-08 |
| 9 cm - 3½"    | ER 4290-09 | ER 4291-09 | ER 4292-09 | ER 4293-09 |
| 10,5 cm - 4¼" | ER 4290-10 | ER 4291-10 | ER 4292-10 | ER 4293-10 |
| 11,5 cm - 4½" | ER 4290-11 | ER 4291-11 | ER 4292-11 | ER 4293-11 |
| 12,5 cm - 5"  | ER 4290-12 | ER 4291-12 | ER 4292-12 | ER 4293-12 |
| 14,5 cm - 5¾" | -          | -          | ER 4270-05 | ER 4270-15 |



gerade  
straight

|               |            |
|---------------|------------|
| 7,5 cm - 3"   | ER 4320-07 |
| 9 cm - 3½"    | ER 4320-09 |
| 11,5 cm - 4½" | ER 4320-11 |



FEILCHENFELD



gerade  
straight



gebogen  
curved

|               |            |            |
|---------------|------------|------------|
| 10,5 cm - 4¼" | ER 4340-10 | ER 4341-10 |
|---------------|------------|------------|



HUNTER



gerade  
straight



gebogen  
curved

|               |            |            |
|---------------|------------|------------|
| 10,5 cm - 4¼" | ER 4350-10 | ER 4351-10 |
|---------------|------------|------------|



WALTER-CARMALT



11 cm - 4¼"  
ER 4358-11



15 cm - 6"  
ER 4364-15



13,5 cm - 5¼"  
ER 4360-13 | ER 4361-13

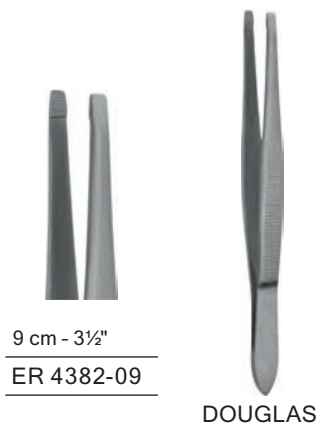
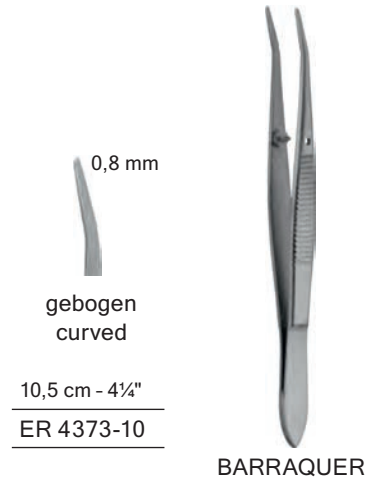



9 cm - 3½"  
ER 4386-09

KUEHNE

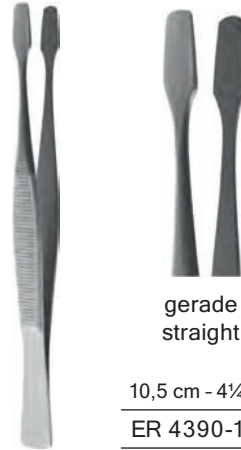

gerade  
straight  
10,5 cm - 4¼"  
ER 4390-10



gebogen  
curved  
10,5 cm - 4¼"  
ER 4392-10

KUEHNE



## Klemmen Clamps



**Arterienklemmen** / Haemostatic forceps

**Ligaturklemmen** / Ligature Forceps

**Klemmzangen** / Clamp Forceps

**Peritoneumklemmen** / Peritoneal Forceps

**Tuchklemmen** / Towel Forceps

**Schlauchklemmen** / Tubing Forceps

**Kornzangen** / Dressing Forceps

**Tupferzangen** / Cotton Swab Forceps

**Schwammzangen** / Sponge Holding Forceps

**Bulldogklemmen** / Bulldog Clamps



gerade straight      gebogen curved      gerade straight      gebogen curved

13 cm - 5"

14 cm - 5½"

|            |            |            |            |
|------------|------------|------------|------------|
| ER 3000-13 | ER 3001-13 | ER 3000-14 | ER 3001-14 |
|------------|------------|------------|------------|

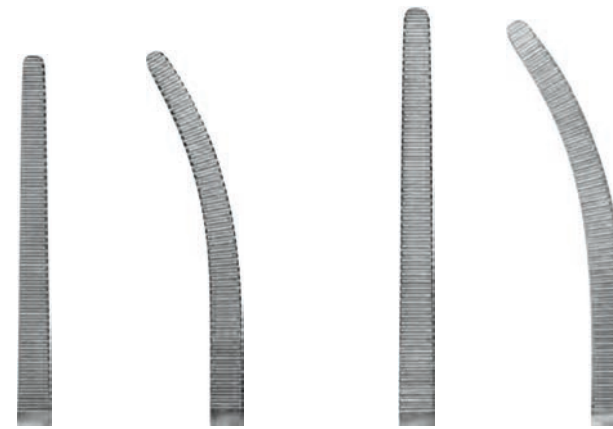

gerade straight      gebogen curved      gerade straight      gebogen curved

16 cm - 6¼"

18 cm - 7"

|            |            |            |            |
|------------|------------|------------|------------|
| ER 3000-16 | ER 3001-16 | ER 3000-18 | ER 3001-18 |
|------------|------------|------------|------------|



ROCHESTER-PEAN

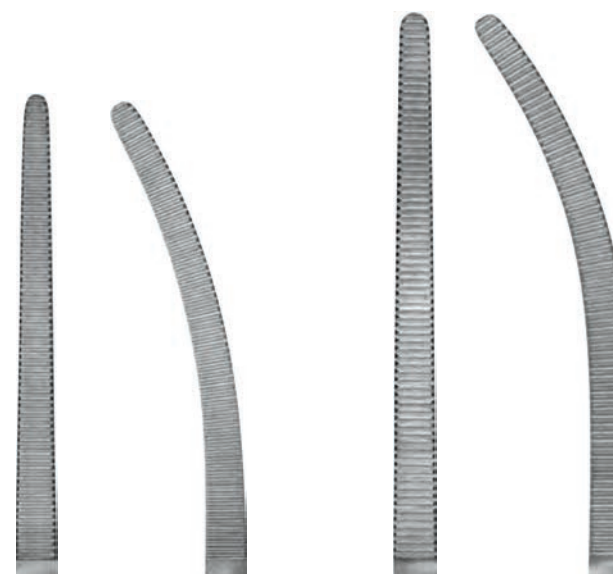

gerade straight      gebogen curved      gerade straight      gebogen curved

20 cm - 8"

22 cm - 8¾"

|            |            |            |            |
|------------|------------|------------|------------|
| ER 3000-20 | ER 3001-20 | ER 3000-22 | ER 3001-22 |
|------------|------------|------------|------------|



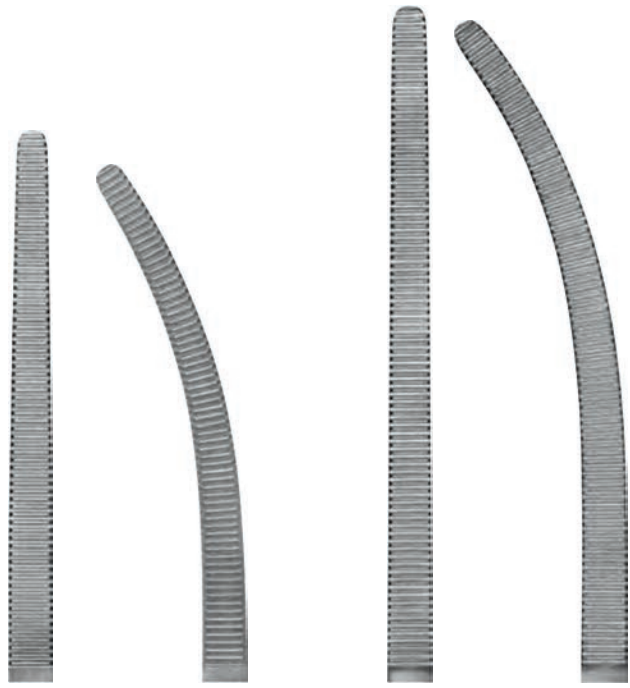

gerade  
straight

gebogen  
curved

gerade  
straight

gebogen  
curved

24 cm - 9½"

26 cm - 10¼"

|            |            |            |            |
|------------|------------|------------|------------|
| ER 3000-24 | ER 3001-24 | ER 3000-26 | ER 3001-26 |
|------------|------------|------------|------------|



ROCHESTER-PEAN

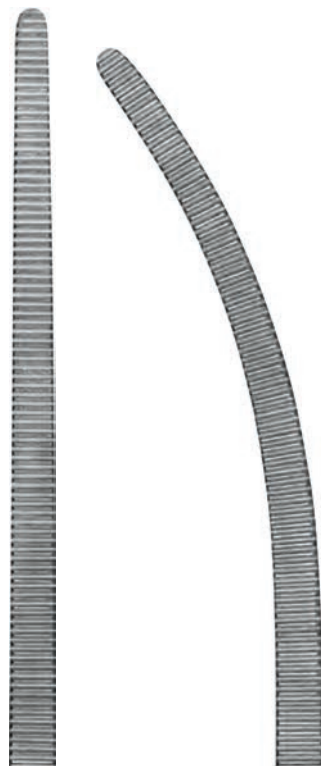

gerade  
straight

gebogen  
curved

30 cm - 11¾"

|            |            |
|------------|------------|
| ER 3000-30 | ER 3001-30 |
|------------|------------|



ROCHESTER-PEAN



1 : 2 Zähne  
1 : 2 teeth

OCHSNER-KOCHER



gerade  
straight



gebogen  
curved



gerade  
straight



gebogen  
curved

13 cm - 5"

14 cm - 5½"

|            |            |            |            |
|------------|------------|------------|------------|
| ER 3010-13 | ER 3011-13 | ER 3010-14 | ER 3011-14 |
|------------|------------|------------|------------|



OCHSNER-KOCHER



gerade  
straight



gebogen  
curved



gerade  
straight



gebogen  
curved

16 cm - 6¼"

18 cm - 7"

|            |            |            |            |
|------------|------------|------------|------------|
| ER 3010-16 | ER 3011-16 | ER 3010-18 | ER 3011-18 |
|------------|------------|------------|------------|



gerade  
straight



gebogen  
curved



gerade  
straight



gebogen  
curved

20 cm - 8"

22 cm - 8¾"

ER 3010-20

ER 3011-20

ER 3010-22

ER 3011-22



1 : 2 Zähne  
1 : 2 teeth



OCHSNER-KOCHER



gerade  
straight



gebogen  
curved



gerade  
straight



gebogen  
curved

24 cm - 9½"

26 cm - 10¼"

ER 3010-24

ER 3011-24

ER 3010-26

ER 3011-26



1 : 2 Zähne  
1 : 2 teeth



OCHSNER-KOCHER



1 : 2 Zähne  
1 : 2 teeth

OCHSNER-KOCHER



gerade  
straight



gebogen  
curved

30 cm - 11¾"

ER 3010-30

ER 3011-30



KELLY



gerade  
straight



gebogen  
curved

14,5 cm - 5¾"

ER 3050-14

ER 3051-14



KELLY-RANKIN



gerade  
straight









gebogen  
curved

16 cm - 6¼"

ER 3050-16







ER 3051-16



|   |   |   |   |   |  |
|---|---|---|---|---|--|
|  |  |  |  |  |  |
| gerade<br>straight  | gebogen<br>curved   | gerade<br>straight  | gebogen<br>curved   | gerade<br>straight  | gebogen<br>curved  |
| 13 cm - 5"  |   | 14 cm - 5½"   |   | 16 cm - 6¼"   |  |
| ER 3020-13  | ER 3021-13  | ER 3020-14  | ER 3021-14  | ER 3020-16  | ER 3021-16   |



PEAN

|   |   |   |   |   |   |
|---|---|---|---|---|---|
|  |  |  |  |  |  |
| gerade<br>straight  | gebogen<br>curved   | gerade<br>straight  | gebogen<br>curved   | gerade<br>straight  | gebogen<br>curved   |
| 13 cm - 5"  |   | 14 cm - 5½"   |   | 16 cm - 6¼"   |   |
| ER 3030-13  | ER 3031-13  | ER 3030-14  | ER 3031-14  | ER 3030-16  | ER 3031-16  |



1 : 2 Zähne  
1 : 2 teeth



KOCHER



CRILE



gerade  
straight



gebogen  
curved



gerade  
straight

1 : 2 Zähne  
1 : 2 teeth



gebogen  
curved

1 : 2 Zähne  
1 : 2 teeth

14 cm - 5 3/4"

|            |            |            |            |
|------------|------------|------------|------------|
| ER 3070-14 | ER 3071-14 | ER 3074-14 | ER 3075-14 |
|------------|------------|------------|------------|



CRILE-RANKIN



gerade  
straight



gebogen  
curved



gerade  
straight

1 : 2 Zähne  
1 : 2 teeth



gebogen  
curved

1 : 2 Zähne  
1 : 2 teeth

16 cm - 6 1/4"

|            |            |            |            |
|------------|------------|------------|------------|
| ER 3070-16 | ER 3071-16 | ER 3074-16 | ER 3075-16 |
|------------|------------|------------|------------|



BABY-CRILE



gerade  
straight



gebogen  
curved

14,5 cm - 5 3/4"

|            |            |
|------------|------------|
| ER 3072-14 | ER 3073-14 |
|------------|------------|



BABY-CRILE



1 : 2 Zähne  
1 : 2 teeth



gerade  
straight



gebogen  
curved

14,5 cm - 5 3/4"

|            |            |
|------------|------------|
| ER 3076-14 | ER 3077-14 |
|------------|------------|





gerade  
straight



gebogen  
curved

14 cm - 5½"

ER 3078-14

ER 3079-14



gerade  
straight



gebogen  
curved

16 cm - 6¼"

ER 3078-16

ER 3079-16



COLLER-CRILE



gerade  
straight



gebogen  
curved

15 cm - 6"

ER 3080-15

ER 3081-15



LERICHE



gerade  
straight



gebogen  
curved

15 cm - 6"

ER 3082-15

ER 3083-15



1 : 2 Zähne  
1 : 2 teeth

LERICHE





PROVIDENCE



gerade straight gebogen curved

14,5 cm - 5¾"

ER 3090-14 | ER 3091-14



HALSTED-MOSQUITO



gerade straight gebogen curved

12,5 cm - 5"

ER 3100-12 | ER 3101-12



HALSTED-MOSQUITO

1 : 2 Zähne  
1 : 2 teeth



gerade straight gebogen curved

12,5 cm - 5"

ER 3110-12 | ER 3111-12



HALSTED-MOSQUITO



gerade straight gebogen curved

14 cm - 5½"

ER 3100-14 | ER 3101-14



HALSTED-MOSQUITO

1 : 2 Zähne  
1 : 2 teeth



gerade straight gebogen curved

14 cm - 5½"

ER 3110-14 | ER 3111-14



JACOBSON



gerade straight gebogen curved

13 cm - 5"

ER 3114-13 | ER 3115-13

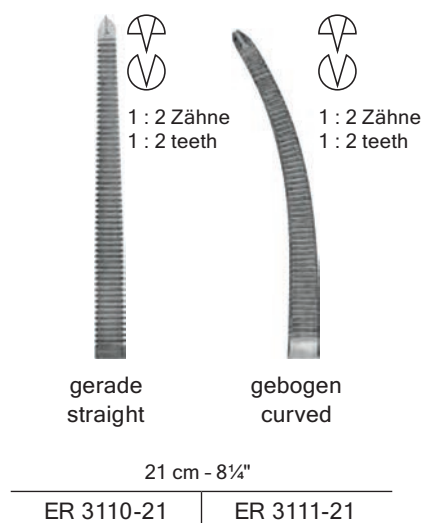
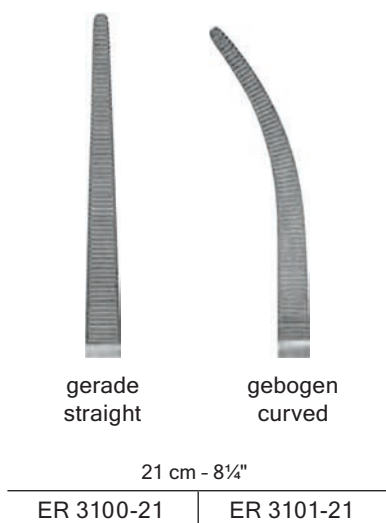
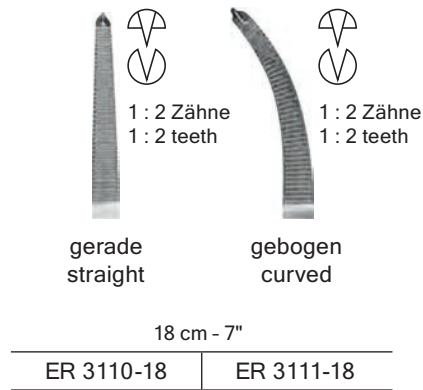
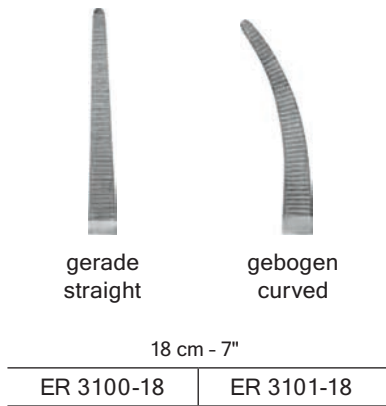



MICRO-MOSQUITO



gerade  
straight



gebogen  
curved

10 cm - 4"

ER 3120-10

ER 3121-10



gerade  
straight



1 : 2 Zähne  
1 : 2 teeth



gebogen  
curved



1 : 2 Zähne  
1 : 2 teeth

10 cm - 4"

ER 3122-10

ER 3123-10



MICRO-MOSQUITO



gerade  
straight



gebogen  
curved

12,5 cm - 5"

ER 3120-12

ER 3121-12



gerade  
straight



1 : 2 Zähne  
1 : 2 teeth



gebogen  
curved



1 : 2 Zähne  
1 : 2 teeth

12,5 cm - 5"

ER 3122-12

ER 3123-12



kurzfassende Maulteile  
short gripping jaws



gerade  
straight

14 cm - 5½"

ER 3153-14



gerade  
straight

16 cm - 6¼"

ER 3153-16



PEAN



gerade  
straight

10 cm - 4"

ER 3140-10



gebogen  
curved

ER 3141-10



gerade  
straight

ER 3142-10



gebogen  
curved

ER 3143-10



HARTMANN



gerade  
straight

8,5 cm - 3½"

ER 3147-10



CARREL



gerade  
straight

13 cm - 5"

ER 3148-13



CHAPUT



TUFFIER



gerade  
straight

13 cm - 5"

ER 3149-13



PENNINGTON



gerade  
straight

15 cm - 6"

ER 3152-15



gebogen  
curved

20 cm - 8"

ER 3152-20



COLLIN



gerade  
straight

15,5 cm - 6"

ER 3155-16



COLLIN



gerade  
straight

14 cm - 5½"

ER 3156-14



COLLIN



gerade  
straight

16,5 cm - 6½"

ER 3157-16



gerade  
straight



gebogen  
curved



gerade  
straight



gebogen  
curved

16 cm - 6 1/4"

20 cm - 8"

ER 3170-16

ER 3171-16

ER 3170-20

ER 3171-20



ROCHESTER-CARMALT



gerade, kreuzgerieft  
straight, cross serrated



1 : 2 Zähne  
1 : 2 teeth

15 cm - 6"

ER 3186-16

ER 3187-16



DIXON-LOVELACE



seitlich gebogen  
curved sideways



1 : 2 Zähne  
1 : 2 teeth

14 cm - 5 1/2"

ER 3182-14

ER 3183-14



DANDY



BAINBRIDGE



gerade  
straight



gebogen  
curved



gerade  
straight



gebogen  
curved

15 cm - 6"

ER 3190-15

ER 3191-15

18 cm - 7"

ER 3190-18

ER 3191-18



ADSON



gerade  
straight



gebogen  
curved

18,5 cm - 7¼"

ER 3200-18

ER 3201-18



BABY-ADSON



leicht gebogen  
slightly curved



stark gebogen  
strongly curved

14 cm - 5½"

ER 3205-14

18 cm - 7"

ER 3205-18





gerade  
straight



gebogen  
curved

20 cm - 8"

ER 3240-20

ER 3241-20



gerade  
straight



gebogen  
curved

26 cm - 10¼"

ER 3240-26

ER 3241-26

kreuzgerieft  
cross serrated



BENGOLEA



gerade  
straight



gebogen  
curved

24 cm - 9½"

ER 3270-24

ER 3271-24



SAROT



BIRKETT



gerade  
straight



gebogen  
curved

19 cm - 7½"

ER 3210-19

ER 3211-19



CRAFOORD



18 cm - 7"

ER 3275-18



gebogen  
curved

24 cm - 9½"

ER 3275-24



gerade  
straight



gebogen  
curved

22 cm - 8¾"

ER 3250-22

ER 3251-22



gebogen  
curved

Fig.1



gebogen  
curved

Fig.2



gebogen  
curved

Fig.3



gebogen  
curved

Fig.4



gebogen  
curved

Fig.5

|            |            |            |            |            |
|------------|------------|------------|------------|------------|
| ER 3280-01 | ER 3280-02 | ER 3280-03 | ER 3280-04 | ER 3280-05 |
| 23 cm - 9" |            |            |            |            |



RUMEL

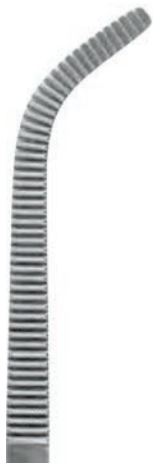

gebogen  
curved

20 cm - 8"

ER 3285-20



JOHNS-HOPKINS



gebogen  
curved

19 cm - 7½"

ER 3279-19



stark gebogen  
strongly curved

24 cm - 9½"

ER 3279-24



stark gebogen  
strongly curved

27,5 cm - 10¾"

ER 3279-26



KANTROWITZ

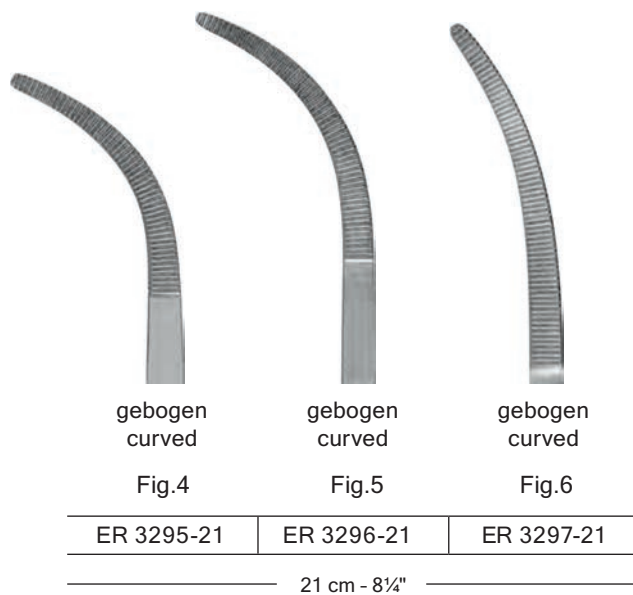
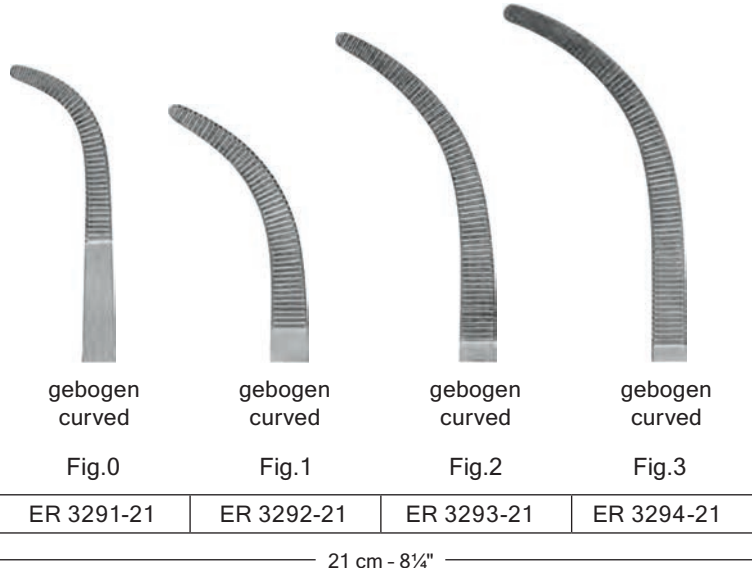

OVERHOLT-GEISSENDÖRFER



1:2



gebogen  
curved

|               |              |             |               |             |
|---------------|--------------|-------------|---------------|-------------|
| 18,5 cm - 7¼" | 20,5 cm - 8" | 21 cm - 8¼" | 21,5 cm - 8½" | 24 cm - 9½" |
| ER 3290-01    | ER 3290-02   | ER 3290-03  | ER 3290-04    | ER 3290-05  |



OVERHOLT-GEISSENDÖRFER

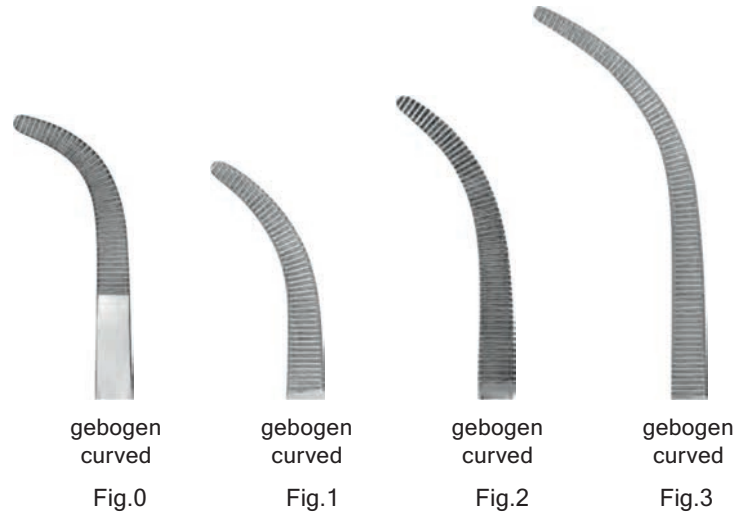

gebogen  
curved  
Fig.0

gebogen  
curved  
Fig.1

gebogen  
curved  
Fig.2

gebogen  
curved  
Fig.3

|            |            |            |            |
|------------|------------|------------|------------|
| ER 3291-27 | ER 3292-27 | ER 3293-27 | ER 3294-27 |
|------------|------------|------------|------------|

27 cm - 10½"

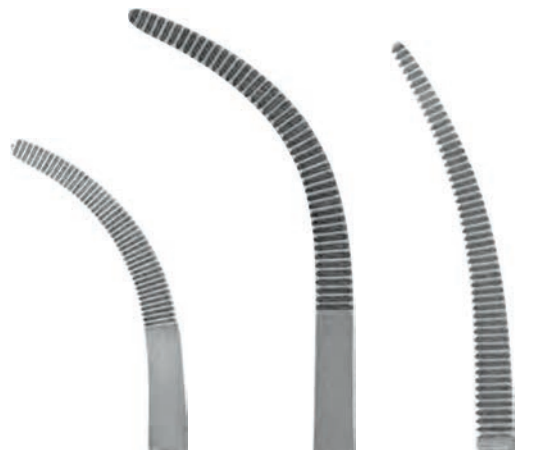

gebogen  
curved  
Fig.4

gebogen  
curved  
Fig.5

gebogen  
curved  
Fig.6

|            |            |            |
|------------|------------|------------|
| ER 3295-27 | ER 3296-27 | ER 3297-27 |
|------------|------------|------------|

27 cm - 10½"

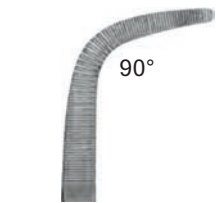

90°

gebogen  
curved

27 cm - 10½"

ER 3308-27



MEEKER

Gallenkanalklemmzange  
Gall duct clamp forceps



gebogen  
curved

18 cm - 7"

ER 3325-18



LOWER



gebogen  
curved

14 cm - 5"

ER 3326-13



gebogen  
curved

18 cm - 7"

ER 3326-18



gebogen  
curved

20 cm - 8"

ER 3326-20



gebogen  
curved

23 cm - 9"

ER 3326-23



gebogen  
curved

25 cm - 10"

ER 3326-25



gebogen  
curved

28 cm - 10½"

ER 3326-27



GEMINI





OVERHOLT-MIXTER



gebogen  
curved

21 cm - 8 1/4"

ER 3298-21



HEISS



gerade  
straight



leicht gebogen  
slightly curved



stark gebogen  
strongly curved

20 cm - 8"

ER 3301-20

ER 3302-20

ER 3303-20



1 : 2 Zähne  
1 : 2 teeth



gerade  
straight



gebogen  
curved

20 cm - 8"

ER 3305-20

ER 3306-20

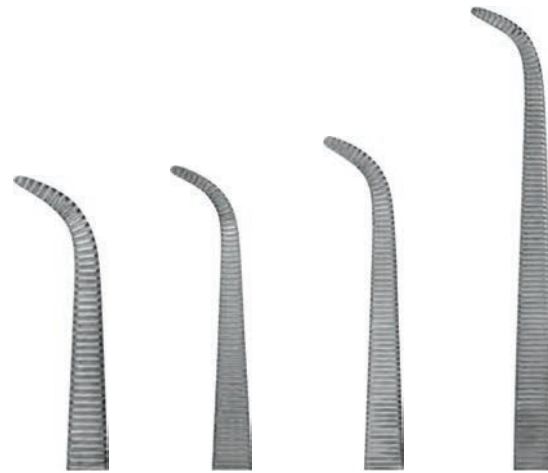

gebogen  
curved

|            |             |             |             |
|------------|-------------|-------------|-------------|
| 18 cm - 7" | 22 cm - 8¾" | 25 cm - 10" | 28 cm - 11" |
| ER 3327-18 | ER 3327-22  | ER 3327-25  | ER 3327-28  |



MINI-GEMINI



gebogen  
curved

|             |             |            |
|-------------|-------------|------------|
| 14 cm - 5½" | 14 cm - 5½" | 18 cm - 7" |
| ER 3328-01  | ER 3328-14  | ER 3328-18 |



BABY-MIXTER



MIXTER

|            |            |
|------------|------------|
| 18 cm - 7" | 18 cm - 7" |
| ER 3330-15 | ER 3330-19 |

gebogen  
curved



MIXTER-O'SHAUGNESSY

|              |             |
|--------------|-------------|
| 15,5 cm - 6" | 19 cm - 7½" |
| ER 3335-15   | ER 3335-19  |

gebogen  
curved



MIXTER

|             |             |             |
|-------------|-------------|-------------|
| 22 cm - 8¾" | 25 cm - 10" | 28 cm - 11" |
| ER 3341-22  | ER 3342-25  | ER 3343-28  |

gebogen  
curved

gebogen  
curved

gebogen  
curved



MIXTER

|            |
|------------|
| 23 cm - 9" |
| ER 3354-23 |



rechts abgewinkelte  
Klemmenbacken mit  
Öse und Längsriefung  
right angled jaws with  
eyelet and longitudinal



gebogen  
curved

24 cm - 9½"

ER 3352-24



gebogen  
curved

|             |            |
|-------------|------------|
| 19 cm - 7½" | 23 cm - 9" |
| ER 3361-19  | ER 3361-23 |





SPENCER-WELLS



gerade  
straight

14 cm - 5½"

ER 3380-14



gerade  
straight

15 cm - 6"

ER 3380-15



gerade  
straight

18 cm - 7"

ER 3380-18



gerade  
straight

20 cm - 8"

ER 3380-20



gebogen  
curved

14 cm - 5½"

ER 3381-14



gebogen  
curved

15 cm - 6"

ER 3381-15



gebogen  
curved

18 cm - 7"

ER 3381-18



gebogen  
curved

20 cm - 8"

ER 3381-20



SCHNIDT

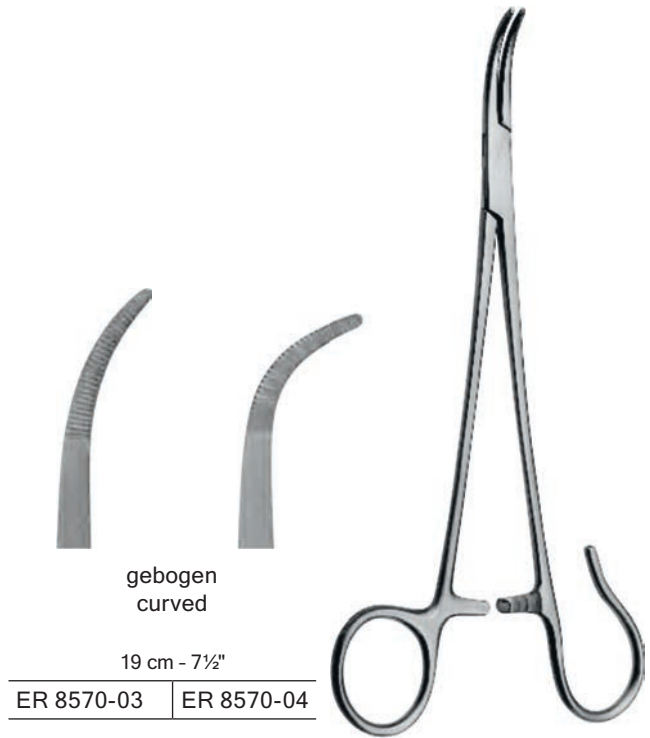

SCHNIDT



BUIE



NEGUS





1 : 2 Zähne  
1 : 2 teeth



BABY-MIKULICZ



gebogen  
curved

14 cm - 5½"

ER 3492-14



1 : 2 Zähne  
1 : 2 teeth



MIKULICZ



gebogen  
curved

20 cm - 8"

ER 3500-20



1 : 2 Zähne  
1 : 2 teeth



MIKULICZ



gebogen  
curved

20 cm - 8"

ER 3501-20



1 : 2 Zähne  
1 : 2 teeth



MIKULICZ



gebogen  
curved

18 cm - 7"

ER 3504-18





gerade  
straight



gebogen  
curved

24 cm - 9½"

ER 3508-24

ER 3509-24



SEGOND-LANDAU



leicht gebogen  
slightly curved

20 cm - 8"

ER 3505-20



1 : 2 Zähne  
1 : 2 teeth



MIKULICZ



leicht gebogen  
slightly curved



gebogen  
curved

20 cm - 8"

ER 3511-20

ER 3512-20



1 : 2 Zähne  
1 : 2 teeth



FAURE



## Tuchklemmen Towel Forceps



gebogen  
curved

9 cm - 3½"

ER 3553-09

1:1

ENGL. MODELL



gebogen  
curved

9 cm - 3½"

ER 3552-09

1:1

JONES



gebogen  
curved

9 cm - 3½"

ER 3550-09

1:1

SCHÄDEL



gebogen  
curved

6 cm - 2½"

ER 3552-05

1:1

JONES



LANE



13 cm - 5"

ER 3622-13



15,5 cm - 6"

ER 3622-15



20 cm - 8"

ER 3622-20



BERNHARD



16,5 cm - 6½"

ER 3620-16



BACKHAUS

|             |            |
|-------------|------------|
| 9 cm - 3½"  | ER 3600-09 |
| 11 cm - 4¼" | ER 3600-11 |
| 13 cm - 5"  | ER 3600-13 |
| 15 cm - 6"  | ER 3600-15 |



TOHOKU



|            |            |
|------------|------------|
| 10 cm - 4" | ER 3605-10 |
| 13 cm - 5" | ER 3605-13 |



Tuchklemme  
mit Schlauch-  
oder Kabelhalter  
Towel forceps  
with clip for tubing  
or cable

|             |            |
|-------------|------------|
| 11 cm - 4¼" | ER 3602-11 |
| 13 cm - 5"  | ER 3602-13 |



ROEDER



|            |            |
|------------|------------|
| 13 cm - 5" | ER 3610-13 |
| 15 cm - 6" | ER 3610-15 |



PEERS-BERTRAM

|               |            |
|---------------|------------|
| 14,5 cm - 5¾" | ER 3604-14 |
|---------------|------------|



LORNA



|            |            |
|------------|------------|
| 10 cm - 4" | ER 3618-10 |
| 13 cm - 5" | ER 3618-13 |



Schlauchklemme  
mit Schutzbügel  
Tubing forceps  
with safety guard

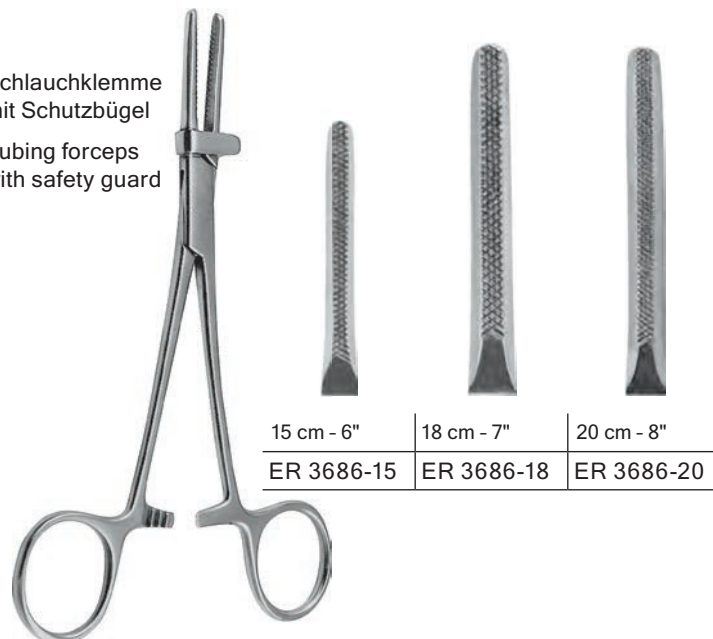



gerade  
straight

gebogen  
curved

gerade  
straight

gebogen  
curved

22 cm - 8¾"

27 cm - 10½"

ER 3800-22

ER 3801-22

ER 3800-27

ER 3801-27



ULRICH

Sinusklemme  
Sinus forceps



gerade  
straight



gerade  
straight



gerade  
straight

12,5 cm - 5"

16 cm - 6¼"

18 cm - 7"

ER 3810-12

ER 3810-16

ER 3810-18



LISTER



gerade  
straight



gebogen  
curved

28 cm - 11"

ER 3874-28

ER 3875-28



SIMS-MAIER





GROSS-MAIER



mit Sperre  
with ratchet



ohne Sperre  
without ratchet

| gerade<br>straight | gebogen<br>curved | gerade<br>straight | gebogen<br>curved |
|--------------------|-------------------|--------------------|-------------------|
| 20 cm - 8"         |                   | 20 cm - 8"         |                   |
| ER 3860-20         | ER 3861-20        | ER 3862-20         | ER 3863-20        |



GROSS-MAIER



mit Sperre  
with ratchet



ohne Sperre  
without ratchet

| gerade<br>straight | gebogen<br>curved | gerade<br>straight | gebogen<br>curved |
|--------------------|-------------------|--------------------|-------------------|
| 25 cm - 10"        |                   | 25 cm - 10"        |                   |
| ER 3860-25         | ER 3861-25        | ER 3862-25         | ER 3863-25        |



gerade  
straight

25 cm - 10"  
ER 3887-25



1:3

COLLIN



gebogen  
curved

25 cm - 10"  
ER 3888-25



1:3

CHERON



gerade  
straight

21 cm - 8¼"  
ER 3889-21



EMMET



gerade  
straight

26 cm - 10¼"  
ER 3890-26



1:3

BOZEMANN





Tupferzangen  
Cotton Swab Forceps



S-gebogen  
S-curved

BOZEMANN



1:3



gebogen  
curved

26 cm - 10 1/4"

ER 3891-26



S-gebogen  
S-curved

BOZEMANN-DOUGLAS



1:3



gebogen  
curved

26 cm - 10 1/4"

ER 3893-26



Zungenzange  
Tongue holding forceps



16 cm - 6 1/4"  
ER 8450-16



COLLIN



gerade, glatt  
straight, smooth

gebogen, glatt  
curved, smooth

|             |            |            |
|-------------|------------|------------|
| 18 cm - 7"  | ER 3900-18 | ER 3901-18 |
| 25 cm - 10" | ER 3900-25 | ER 3901-25 |



FÖRSTER-BALLENGER



## Schwammzangen Sponge Holding Forceps



RAMPLAY



gerade  
straight

|            |             |
|------------|-------------|
| 18 cm - 7" | 25 cm - 10" |
| ER 3896-18 | ER 3896-25  |



FÖRSTER-BALLENGER



gerade, gerieft  
straight, serrated

gebogen, gerieft  
curved, serrated

|             |            |            |
|-------------|------------|------------|
| 18 cm - 7"  | ER 3910-18 | ER 3911-18 |
| 25 cm - 10" | ER 3910-25 | ER 3911-25 |



1:1

DIEFFENBACH

gerade  
straight

gebogen  
curved

|              |            |            |
|--------------|------------|------------|
| 3,5 cm - 1½" | ER 3144-03 | ER 3145-03 |
| 5 cm - 2"    | ER 3144-05 | ER 3145-05 |



1:1

JOHNS-HOPKINS

gerade  
straight

gebogen  
curved

|              |            |            |
|--------------|------------|------------|
| 5 cm - 2"    | ER 3146-12 | ER 3146-02 |
| 5,5 cm - 2¼" | ER 3146-13 | ER 3146-03 |
| 6,5 cm - 2½" | ER 3146-14 | ER 3146-04 |
| 7 cm - 2¾"   | ER 3146-15 | ER 3146-05 |
| 7,5 cm - 3"  | ER 3146-16 | ER 3146-06 |
| 9 cm - 3½"   | ER 3146-17 | ER 3146-07 |

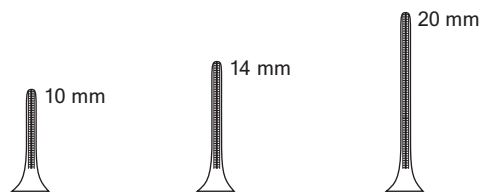

|             |             |              |
|-------------|-------------|--------------|
| 4,7 cm - 2" | 5,1 cm - 2" | 5,7 cm - 2¼" |
| ER 3934-60  | ER 3934-64  | ER 3934-70   |

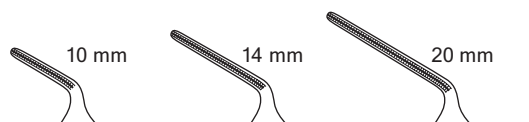

|              |              |             |
|--------------|--------------|-------------|
| 4,4 cm - 1½" | 4,6 cm - 1½" | 4,9 cm - 2" |
| ER 3935-60   | ER 3935-64   | ER 3935-70  |



DE BAKEY Zahnung  
DE BAKEY Serration



1:1  
DIETRICH

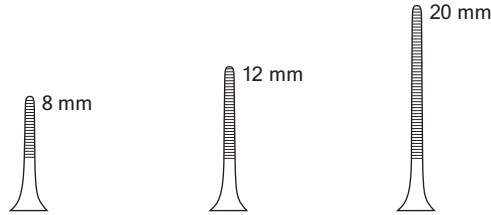

|             |             |              |
|-------------|-------------|--------------|
| 4,9 cm - 2" | 5,3 cm - 2" | 5,6 cm - 2¼" |
| ER 3934-08  | ER 3934-12  | ER 3934-16   |

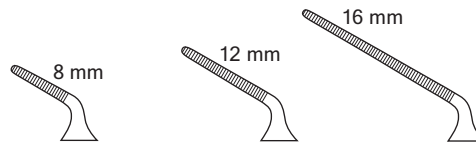

|              |              |              |
|--------------|--------------|--------------|
| 4,3 cm - 1½" | 4,5 cm - 1½" | 5,6 cm - 2¼" |
| ER 3935-08   | ER 3935-12   | ER 3935-16   |



**Retraktoren**  
*Retractors*



**Feine Wundhäkchen** / *Fine Wound Retractors*

**Wund- und Trachealhäkchen** / *Wound and Trachea Retractors*

**Wundhaken** / *Retractors*

**Spatel** / *Spatulas*

**Wundspreizer** / *Self-retaining Retractors*

**Spezialwundspreizer** / *Special Retractors*

**Bauchdeckenhalter** / *Abdominal Retractors*

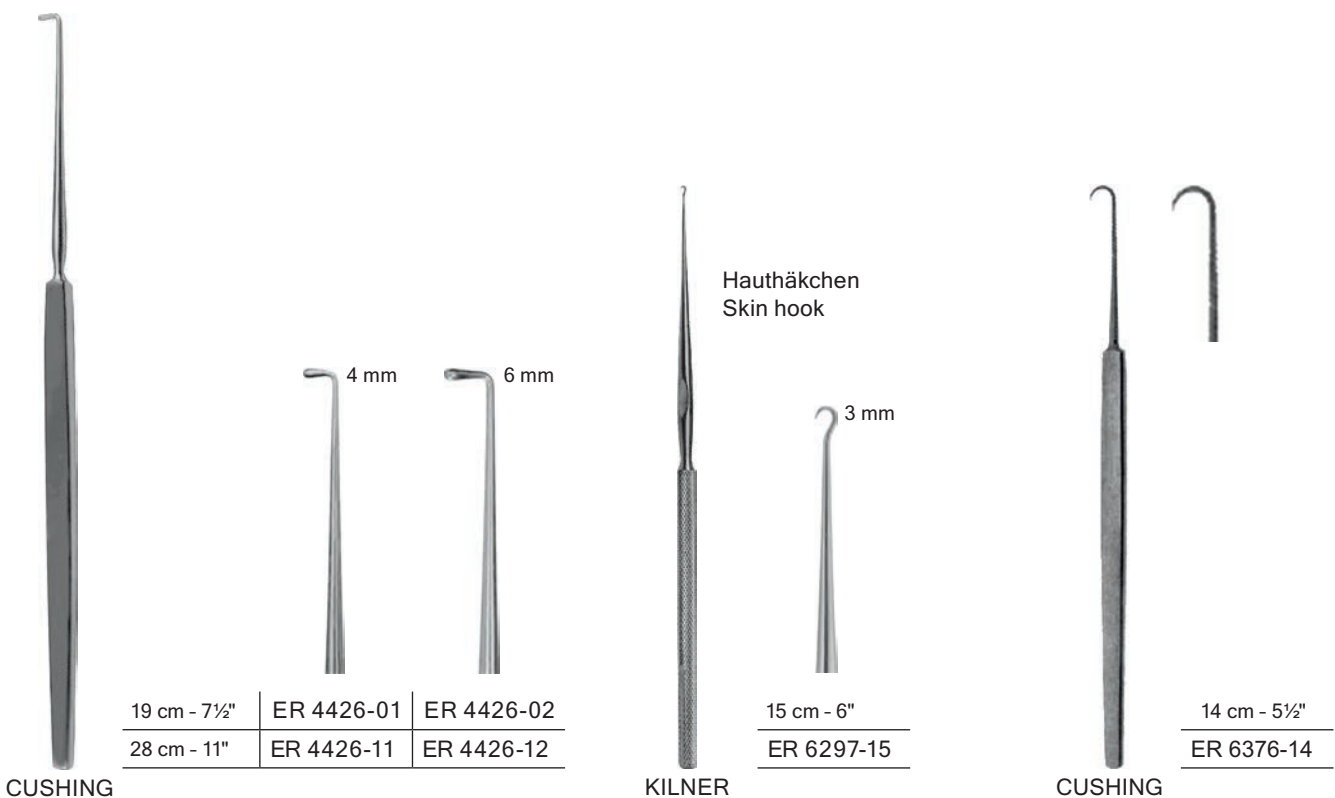
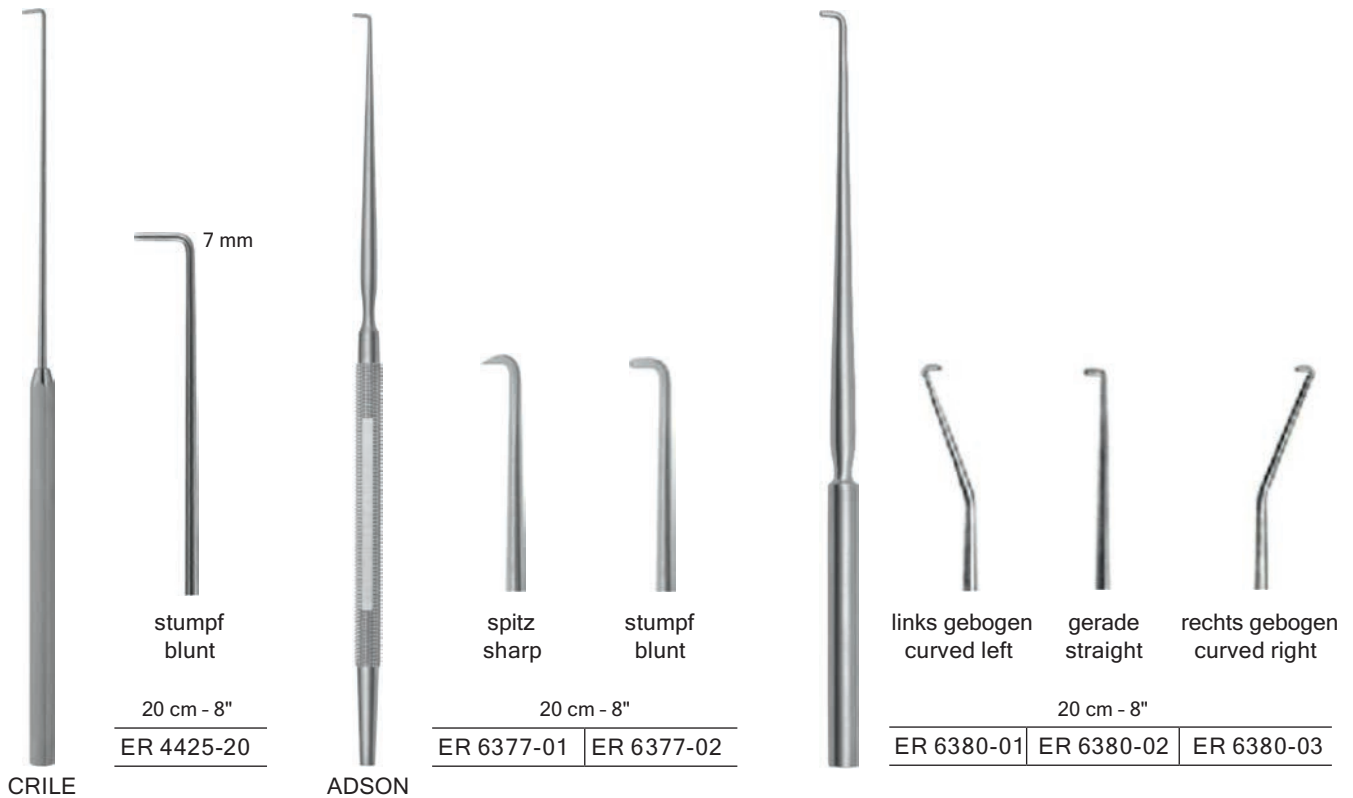





Hauthäkchen  
Skin hook



scharf  
sharp

stumpf  
blunt

12 cm - 4¾"

ER 4430-51

ER 4430-52

GRAEFE



scharf  
sharp

stumpf  
blunt

13,5 cm - 5¼"

ER 4432-04

ER 4432-14



ROLLET



scharf  
sharp

16 cm - 6¼"

ER 4430-53



GUTHRIE

für Endometrie  
for endometrie



1:3  
NOVAK



23 cm - 9"

Ø 1 mm ER 7245-01

Ø 2 mm ER 7245-02

Ø 3 mm ER 7245-03

Ø 4 mm ER 7245-04



scharf  
sharp

12,5 cm - 5"

ER 4430-70



O'CONNOR



scharf  
sharp

13 cm - 5"

ER 4435-03

ER 4435-05

ER 4435-07



KLEINERT-KUTZ



scharf  
sharp

18 cm - 7"

Fig. 1

ER 6296-01

Fig. 2

ER 6296-02



GILLIES



10 x 6 mm

17 x 5 mm



16,5 cm - 6½"

ER 4430-10

ER 4430-17

20 x 6 mm

22 x 8 mm



16,5 cm - 6½"

ER 4430-20

ER 4430-22



MINI-LANGENBECK



JACKSON

17 cm - 6¾"

ER 4439-17



Trachealhäkchen  
Trachea hook

15 cm - 6"

ER 4440-15

NEWS



1:3  
GIL-VERNET



scharf  
sharp

17 cm - 6½"

|            |            |            |            |
|------------|------------|------------|------------|
| ER 4460-01 | ER 4460-02 | ER 4460-03 | ER 4460-04 |
|------------|------------|------------|------------|



stumpf  
blunt

17 cm - 6½"

|            |            |            |            |
|------------|------------|------------|------------|
| ER 4461-01 | ER 4461-02 | ER 4461-03 | ER 4461-04 |
|------------|------------|------------|------------|



Standard  
Standard  
Large curve  
Große Kurve



scharf  
sharp

17 cm - 6¼"

|            |            |            |            |
|------------|------------|------------|------------|
| ER 4462-01 | ER 4462-02 | ER 4462-03 | ER 4462-04 |
|------------|------------|------------|------------|



stumpf  
blunt

17 cm - 6¼"

|            |            |            |            |
|------------|------------|------------|------------|
| ER 4463-01 | ER 4463-02 | ER 4463-03 | ER 4463-04 |
|------------|------------|------------|------------|



fein  
delicate  
Small Curve  
Kleine Kurve



flexibel  
flexible



scharf  
sharp

15,5 cm - 6"

|            |            |            |            |
|------------|------------|------------|------------|
| ER 4464-01 | ER 4464-02 | ER 4464-03 | ER 4464-04 |
|------------|------------|------------|------------|



stumpf  
blunt

15,5 cm - 6"

|            |            |            |            |
|------------|------------|------------|------------|
| ER 4465-01 | ER 4465-02 | ER 4465-03 | ER 4465-04 |
|------------|------------|------------|------------|



scharf  
sharp



stumpf  
blunt

16 cm - 6¼"

|            |            |
|------------|------------|
| ER 4466-01 | ER 4466-02 |
|------------|------------|



JACKSON

13 cm - 5"

ER 4468-13



KNAPP



13,5 cm - 5¼"

ER 9405-13



BERGMANN



14 cm - 5½"

ER 4469-14



scharf  
sharp

stumpf  
blunt

16 cm - 6¼"

|            |            |
|------------|------------|
| Fig. 1     | Fig. 2     |
| ER 4471-01 | ER 4471-02 |



ITERSON



scharf  
sharp

11,5 cm - 4½"

|            |            |            |            |
|------------|------------|------------|------------|
| ER 4472-02 | ER 4472-03 | ER 4472-04 | ER 4472-06 |
|------------|------------|------------|------------|



stumpf  
blunt

11,5 cm - 4½"

|            |            |            |            |
|------------|------------|------------|------------|
| ER 4473-02 | ER 4473-03 | ER 4473-04 | ER 4473-06 |
|------------|------------|------------|------------|



MINI-VOLKMANN



## Wundhaken Retractors



1:3

CUSHING



25 cm - 10"

|            |            |
|------------|------------|
| 11 x 14 mm | ER 4456-81 |
| 13 x 18 mm | ER 4456-82 |
| 15 x 22 mm | ER 4456-83 |



CUSHING



| Breite<br>Width | 20 cm - 8" |
|-----------------|------------|
| 8 mm            | ER 4474-08 |
| 10 mm           | ER 4474-10 |
| 12 mm           | ER 4474-12 |
| 14 mm           | ER 4474-14 |
| 16 mm           | ER 4474-16 |
| 18 mm           | ER 4474-18 |



| Breite<br>Width | 24 cm - 9½" |
|-----------------|-------------|
| 8 mm            | ER 4474-58  |
| 10 mm           | ER 4474-60  |
| 12 mm           | ER 4474-62  |
| 14 mm           | ER 4474-64  |
| 16 mm           | ER 4474-66  |
| 18 mm           | ER 4474-68  |



1:3  
CUSHING



| Breite<br>Width | 16 cm - 6¼" |
|-----------------|-------------|
| 8 mm            | ER 4475-08  |
| 10 mm           | ER 4475-10  |
| 11 mm           | ER 4475-11  |
| 12 mm           | ER 4475-12  |
| 13 mm           | ER 4475-13  |
| 14 mm           | ER 4475-14  |
| 15 mm           | ER 4475-15  |
| 16 mm           | ER 4475-16  |
| 18 mm           | ER 4475-18  |



DESMARRES

12 x 4 mm



11 cm - 4¼"  
ER 4478-11

20 x 6 mm

CRILE

11 x 9 mm



11 cm - 4¼"  
ER 4479-11

13 x 11 mm

LUER





Dekompressionshaken  
Decompression hook

CUSHING



20 cm - 8"

ER 4485-20



7 x 8 mm



scharf  
sharp

stumpf  
blunt

16 cm - 6 1/4"

ER 4486-01

ER 4486-02

18 x 6 mm

SENN-MUELLER



13 x 6 mm

20 cm - 8"

ER 6257-21

CHOENBORN



7 x 3,5 mm



14 x 5 mm

15 cm - 6"

ER 4488-14

RAGNELL-DAVIS

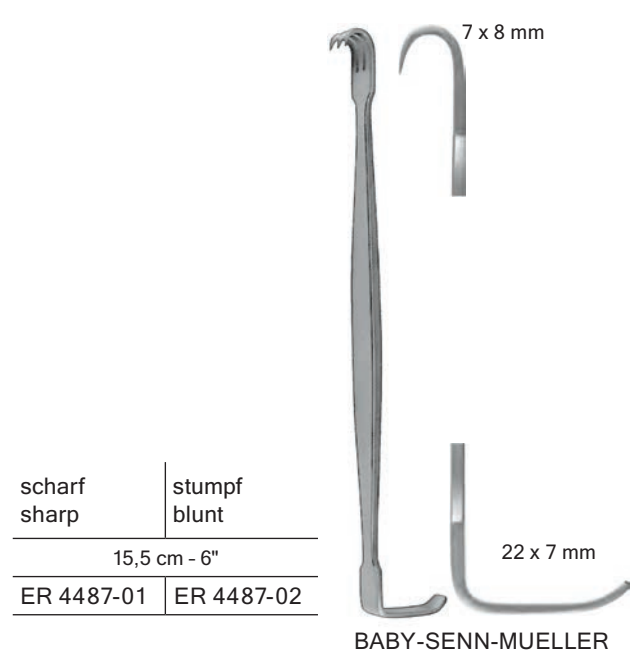
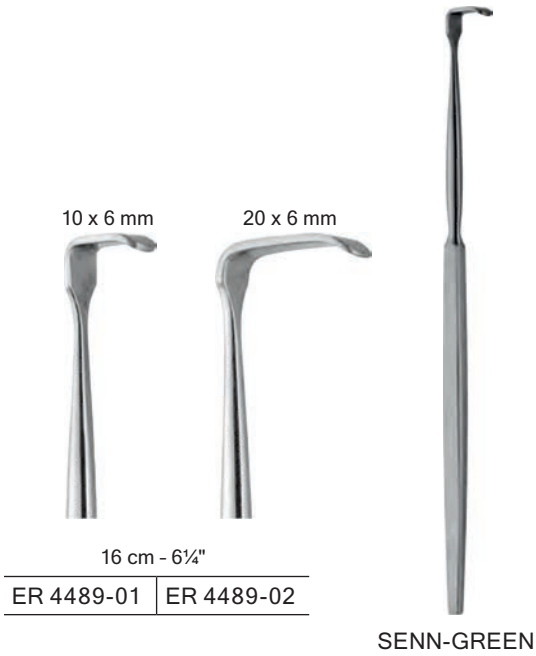

ER 4492-00

---

Satz bestehend aus:  
ER 4492-01, ER 4492-02, ER 4492-03  
Set consisting of:  
ER 4492-01, ER 4492-02, ER 4492-03

---

|                |        |            |
|----------------|--------|------------|
| 14 cm - 5 1/2" | Fig. 1 | ER 4492-01 |
| 15 cm - 6"     | Fig. 2 | ER 4492-02 |
| 17 cm - 6 3/4" | Fig. 3 | ER 4492-03 |

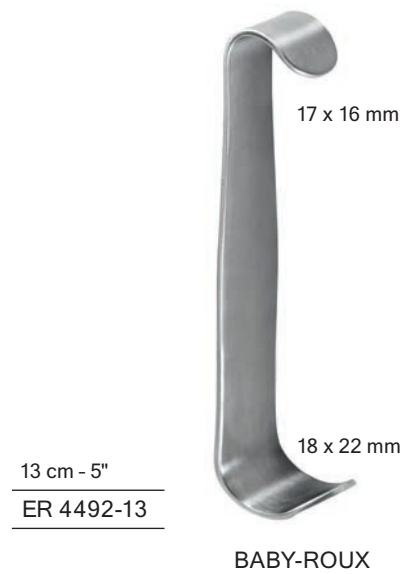

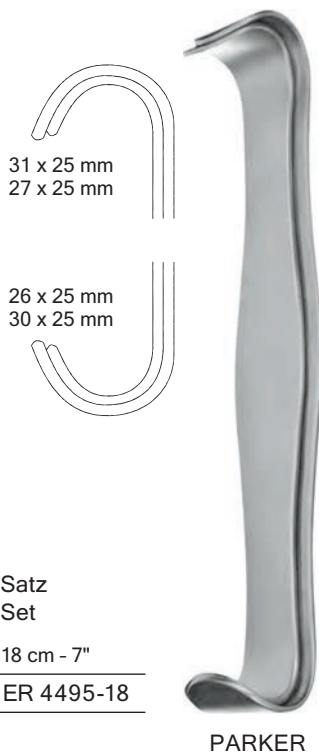
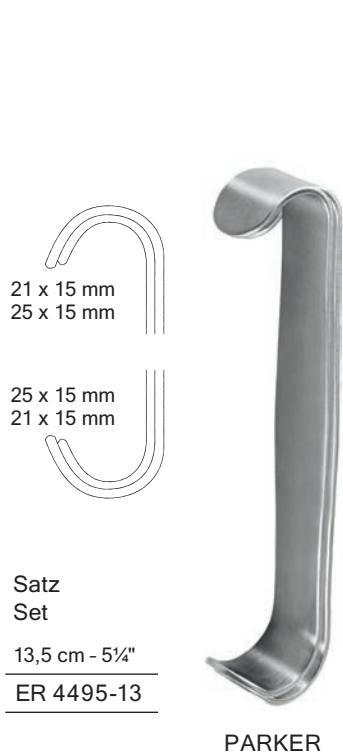



Satz  
Set

12 cm - 4¾"

ER 4497-12



FARABEUF

Satz  
Set

15 cm - 6"

ER 4497-15

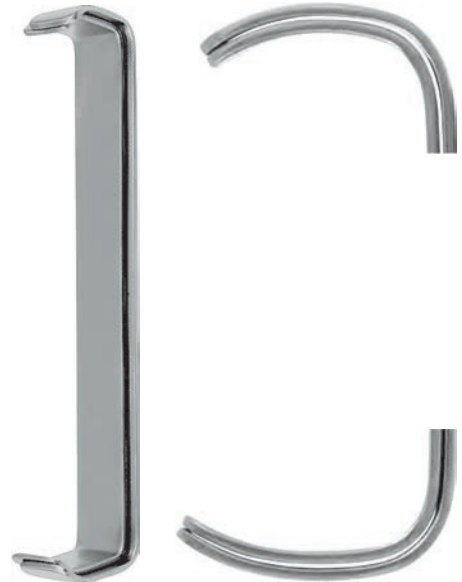

FARABEUF

Satz  
Set

16,5 cm - 6½"

ER 4498-00



COLLIN

Satz  
Set

19 cm - 7½"

ER 4499-00



MATHIEU



**Wundhaken  
Retractors**



1:3  
ISRAEL



40 x 40 mm

1:2

25 cm - 10"

ER 4517-01

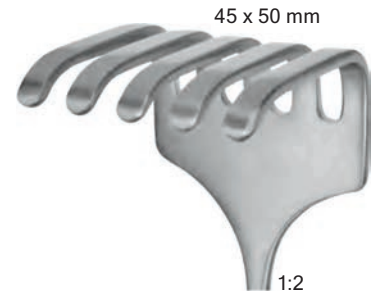

45 x 50 mm

1:2

25 cm - 10"

ER 4517-02

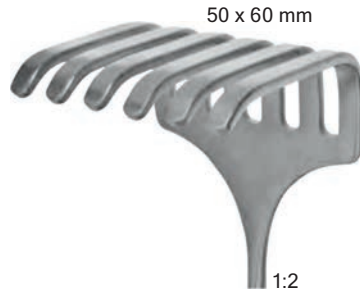

50 x 60 mm

1:2

25 cm - 10"

ER 4517-03

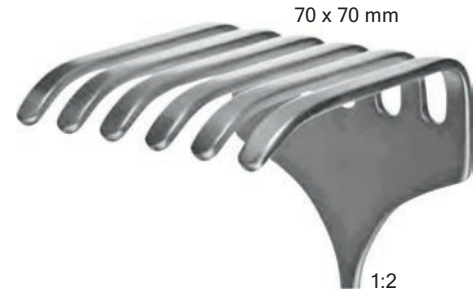

70 x 70 mm

1:2

25 cm - 10"

ER 4517-04



46 x 55 mm

Griff vertikal  
vertical handle

23 cm - 9"

ER 4518-00

KÖRTE



36 x 55 mm

22,5 cm - 8¾"

ER 4510-04



OLLIER

85 x 15 mm

Griff vertikal  
vertical handle

21,5 cm - 8½"

ER 4522-21

LANGENBECK



|            |             |
|------------|-------------|
|            | 21 cm - 8¼" |
| 55 x 20 mm | ER 4522-01  |
| 63 x 20 mm | ER 4522-02  |

LANGENBECK

Hohlheftgriff  
Hollow handle

|            |             |
|------------|-------------|
|            | 22 cm - 8¾" |
| 30 x 11 mm | ER 4531-01  |
| 40 x 11 mm | ER 4531-05  |
| 42 x 13 mm | ER 4531-06  |

LANGENBECK



|            |               |
|------------|---------------|
|            | 22,5 cm - 8¾" |
| 45 x 15 mm | ER 4526-01    |
| 55 x 23 mm | ER 4526-02    |
| 72 x 20 mm | ER 4526-03    |

SAUERBRUCH



28 x 6 mm

|  |             |
|--|-------------|
|  | 19 cm - 7½" |
|  | ER 4525-19  |

LAHEY



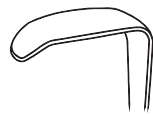

30 x 11 mm

ER 4530-01



30 x 14 mm

ER 4530-02



30 x 16 mm

ER 4530-04



40 x 11 mm

ER 4530-05



50 x 11 mm

ER 4530-07

21 cm - 8 1/4"

LANGENBECK



38 x 20 mm

23 cm - 9"

ER 4535-01

KOCHER



KOCHER



19 cm - 7 1/2"

19 x 12 mm | ER 4536-01

21 x 14 mm | ER 4536-02





|            |               |
|------------|---------------|
|            | 21,5 cm - 8½" |
| 25 x 6 mm  | ER 4538-11    |
| 25 x 8 mm  | ER 4538-12    |
| 35 x 8 mm  | ER 4538-13    |
| 35 x 11 mm | ER 4538-14    |
| 35 x 15 mm | ER 4538-15    |
| 40 x 11 mm | ER 4538-16    |
| 55 x 11 mm | ER 4538-17    |
| 70 x 14 mm | ER 4538-18    |
| 80 x 12 mm | ER 4538-19    |
| 80 x 16 mm | ER 4538-20    |



KOCHER-LANGENBECK

67 x 17 mm



21,5 cm - 8½"  
ER 4537-21

CASPAR

|             |             |
|-------------|-------------|
|             | 25 cm - 10" |
| 60 x 20 mm  | ER 4542-01  |
| 80 x 30 mm  | ER 4542-02  |
| 100 x 30 mm | ER 4542-03  |
| 120 x 30 mm | ER 4542-04  |
| 140 x 30 mm | ER 4542-05  |
| 140 x 40 mm | ER 4542-06  |



HÖSEL

|            |            |
|------------|------------|
|            | 23 cm - 9" |
| 40 x 18 mm | ER 4539-11 |
| 60 x 20 mm | ER 4539-12 |
| 60 x 25 mm | ER 4539-13 |
| 75 x 30 mm | ER 4539-14 |
| 75 x 40 mm | ER 4539-15 |



1:3  
KOCHER



|               |             |            |
|---------------|-------------|------------|
| 30,5 cm - 12" | 75 x 23 mm  | ER 4548-30 |
| 33 cm - 13"   | 175 x 23 mm | ER 4548-33 |

1:3  
WYLLIE



|            |                |
|------------|----------------|
|            | 21 cm - 8 1/4" |
| 70 x 40 mm | ER 4544-40     |
| 70 x 50 mm | ER 4544-50     |
| 70 x 65 mm | ER 4544-65     |

MORRIS



|                  |            |            |
|------------------|------------|------------|
| 21,5 cm - 8 1/2" | 15 x 15 mm | ER 4551-01 |
| 22 cm - 8 3/4"   | 20 x 22 mm | ER 4551-02 |
| 23,5 cm - 9 1/4" | 28 x 28 mm | ER 4551-03 |

MIDDELDORPF



|                |
|----------------|
| 22 cm - 8 3/4" |
| ER 4549-22     |

GREEN



#### ER 4553-00

Satz bestehend aus:  
ER 4553-01, ER 4553-02

Set consisting of:  
ER 4553-01, ER 4553-02

|              |                            |        |            |
|--------------|----------------------------|--------|------------|
| 25 cm - 10"  | 24 x 22 mm /<br>30 x 30 mm | Fig. 1 | ER 4553-01 |
| 27 cm - 10½" | 40 x 37 mm /<br>65 x 43 mm | Fig. 2 | ER 4553-02 |

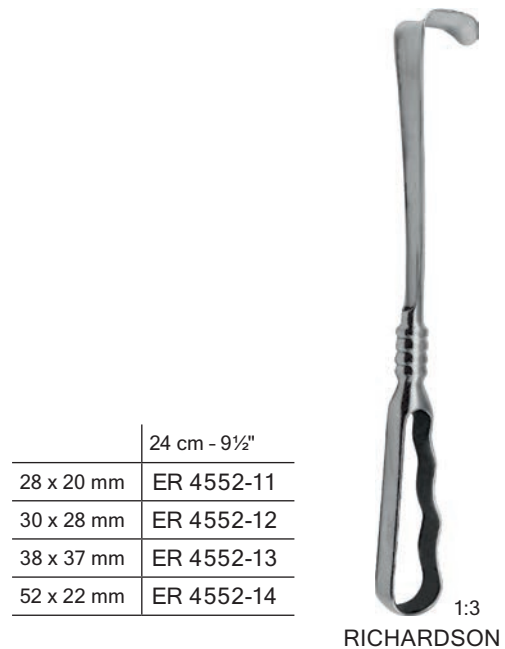
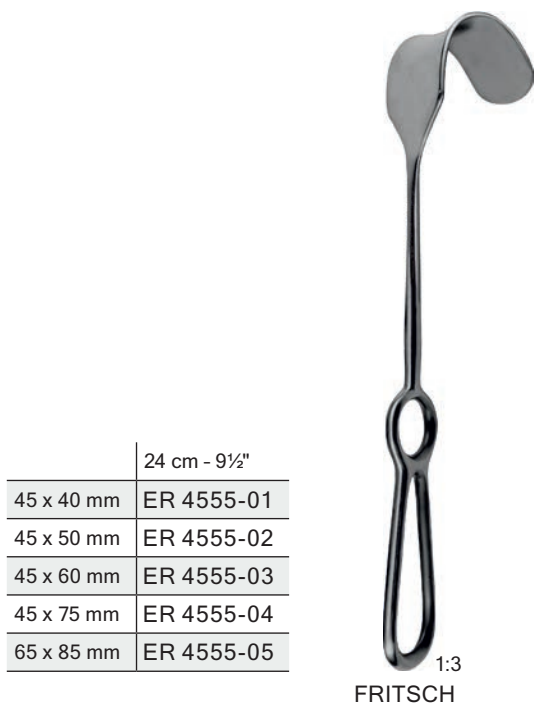



|            |              |
|------------|--------------|
|            | 26 cm - 10¼" |
| 40 x 50 mm | ER 4554-00   |
| 50 x 65 mm | ER 4554-01   |
| 65 x 75 mm | ER 4554-02   |
| 75 x 90 mm | ER 4554-03   |

1:3  
KELLY

70 x 25 mm



|  |               |
|--|---------------|
|  | 22,5 cm - 8¾" |
|  | ER 4557-22    |

KOCHER



|            |             |
|------------|-------------|
|            | 25 cm - 10" |
| 80 x 42 mm | ER 4558-01  |
| 80 x 50 mm | ER 4558-02  |
| 80 x 60 mm | ER 4558-03  |

1:3  
KOCHER



|             |             |
|-------------|-------------|
|             | 28 cm - 11" |
| 115 x 22 mm | ER 4560-01  |
| 115 x 27 mm | ER 4560-02  |

1:3  
SIMON





DEAVER

|              |            |
|--------------|------------|
| 30 cm - 11¼" | ER 4570-04 |
| 33 cm - 13"  | ER 4570-05 |
| 36 cm - 14¼" | ER 4570-06 |



DEAVER



DEAVER

|              |            |
|--------------|------------|
| 30 cm - 11¼" |            |
| 25 mm        | ER 4571-04 |
| 38 mm        | ER 4571-07 |
| 50 mm        | ER 4571-08 |
| 75 mm        | ER 4571-09 |

Hohlgriff  
Hollow handle



DEAVER

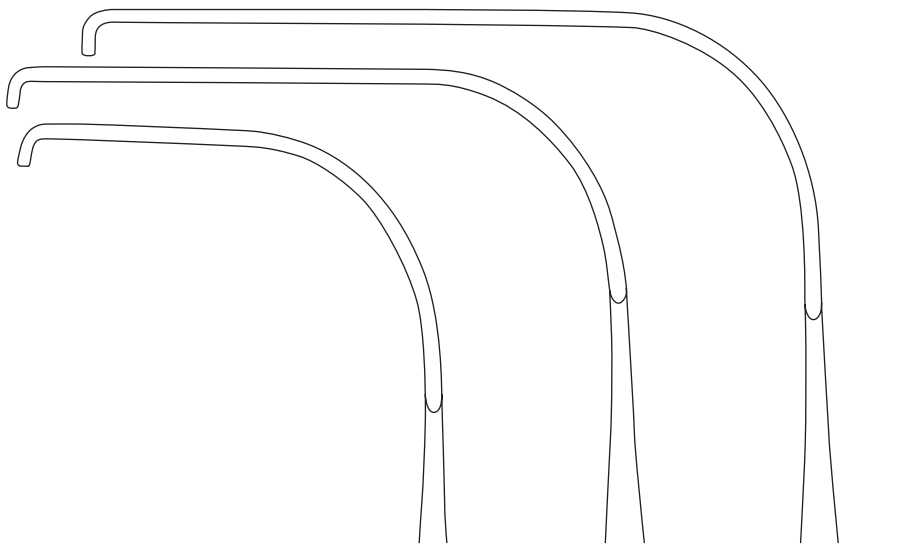

|            |            |               |
|------------|------------|---------------|
| 52 x 16 mm | 76 x 25 mm | 89 x 50 mm    |
| 23 cm - 9" | 23 cm - 9" | 25,5 cm - 10" |
| ER 4573-01 | ER 4573-02 | ER 4573-03    |



MEYERDING



HARRINGTON

|             |              |
|-------------|--------------|
|             | 32 cm - 12½" |
| 40 x 127 mm | ER 4572-01   |
| 62 x 127 mm | ER 4572-02   |

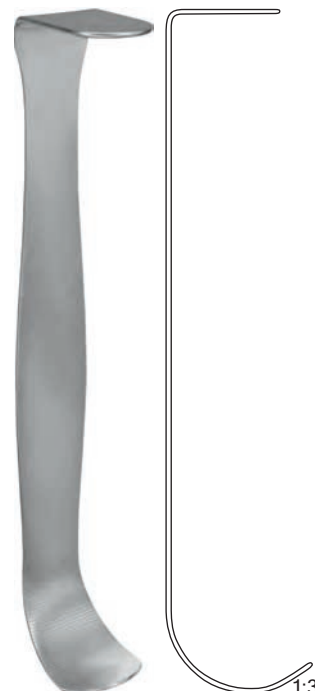

HEANEY

|            |              |
|------------|--------------|
|            | 27 cm - 10½" |
| 45 x 25 mm | ER 4575-51   |
| 73 x 28 mm | ER 4575-52   |
| 82 x 28 mm | ER 4575-53   |





HIBBS

ER 4575-00  
Satz bestehend aus:  
ER 4575-01, ER 4575-02  
Set consisting of:  
ER 4575-01, ER 4575-02

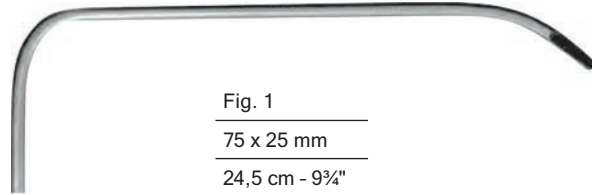

Fig. 1  
75 x 25 mm  
24,5 cm - 9 $\frac{3}{4}$ "  
ER 4575-01

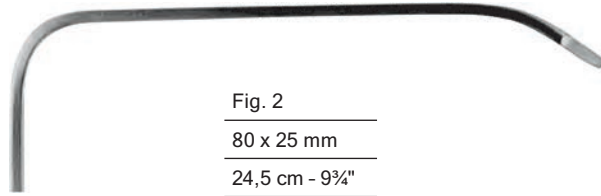

Fig. 2  
80 x 25 mm  
24,5 cm - 9 $\frac{3}{4}$ "  
ER 4575-02



1:3  
BRUNNER

ER 4543-29  
ER 4543-32  
ER 4543-33

|             |               |
|-------------|---------------|
|             | 25,5 cm - 10" |
| 80 x 20 mm  | ER 4564-01    |
| 100 x 20 mm | ER 4564-02    |
| 120 x 25 mm | ER 4564-03    |
| 140 x 25 mm | ER 4564-04    |
| 160 x 30 mm | ER 4564-05    |
| 180 x 30 mm | ER 4564-06    |



1:3  
MIKULICZ

|             |                            |
|-------------|----------------------------|
|             | 26 cm - 10 $\frac{1}{4}$ " |
| 85 x 35 mm  | ER 4565-01                 |
| 120 x 50 mm | ER 4565-02                 |
| 155 x 50 mm | ER 4565-03                 |





## Spatel Spatulas



biegsam  
malleable

|       |             |
|-------|-------------|
|       | 33 cm - 13" |
| 20 mm | ER 4580-20  |
| 25 mm | ER 4580-25  |
| 30 mm | ER 4580-30  |
| 35 mm | ER 4580-35  |
| 40 mm | ER 4580-40  |
| 45 mm | ER 4580-45  |
| 50 mm | ER 4580-50  |

1:3



biegsam  
malleable

|            |
|------------|
| 17 / 25 mm |
| 20 cm - 8" |
| ER 4582-20 |

TUFFIER



biegsam  
malleable

|             |       |            |
|-------------|-------|------------|
| 20 cm - 8"  | 6 mm  | ER 4584-06 |
|             | 8 mm  | ER 4584-08 |
|             | 10 mm | ER 4584-10 |
|             | 12 mm | ER 4584-12 |
|             | 17 mm | ER 4584-17 |
|             | 20 mm | ER 4584-20 |
| 25 cm - 10" | 25 mm | ER 4584-29 |



biegsam  
malleable

|              |            |            |
|--------------|------------|------------|
| 30 cm - 11¼" | 40 / 50 mm | ER 4585-03 |
|--------------|------------|------------|

1:3

HABERER



28,5 cm - 11¼"

ER 4587-28

1:3

REVERDIN



|           | scharf<br>sharp | stumpf<br>blunt |
|-----------|-----------------|-----------------|
| 5 cm - 2" | ER 4640-05      | ER 4641-05      |

2 : 3 Zähne  
2 : 3 teeth



FINSEN

|            | scharf<br>sharp | stumpf<br>blunt |
|------------|-----------------|-----------------|
| 7 cm - 2¾" | ER 4640-07      | ER 4641-07      |

3 : 4 Zähne  
3 : 4 teeth



FINSEN

|            |            |            |
|------------|------------|------------|
| 7 cm - 2¾" | ER 4650-07 | ER 4651-07 |
| 10 cm - 4" | ER 4650-10 | ER 4651-10 |



scharf  
sharp



stumpf  
blunt



ALM

|            |            |
|------------|------------|
| 7 cm - 2¾" | ER 4642-07 |
|------------|------------|

scharf  
sharp



FINSEN

|                                     |            |            |
|-------------------------------------|------------|------------|
| 10 cm - 4"                          |            |            |
| Spreizweite: 45 mm<br>Spread: 45 mm | ER 4680-10 | ER 4681-10 |



scharf  
sharp



stumpf  
blunt

3 : 3 Zähne  
3 : 3 teeth



JANSEN

|            |            |
|------------|------------|
| 10 cm - 4" |            |
| ER 4655-00 | ER 4655-10 |



scharf  
sharp



stumpf  
blunt



HEISS



## Wundspreizer Self-retaining Retractors



PLESTER

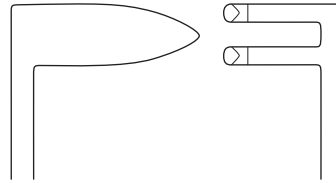
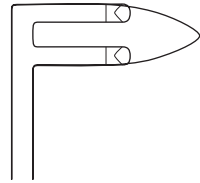

Spreizweite: 55 mm  
Spread: 55 mm

Blatt links voll, scharf  
Blatt rechts 2 Zähne, scharf  
Blade left solid, sharp  
Blade left 2 teeth, sharp

11 cm - 4 1/4"

ER 4690-01



PLESTER

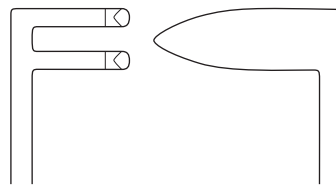
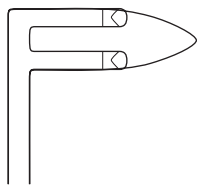

Spreizweite: 55 mm  
Spread: 55 mm

Blatt rechts voll, scharf  
Blatt links 2 Zähne, scharf  
Blade right solid, sharp  
Blade left 2 teeth, sharp

11 cm - 4 1/4"

ER 4690-02



PLESTER

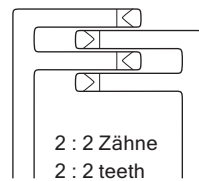

2 : 2 Zähne  
2 : 2 teeth  
scharf sharp      stumpf blunt

Spreizweite: 60 mm  
Spread: 60 mm

13 cm - 5"

ER 4691-01

ER 4691-02

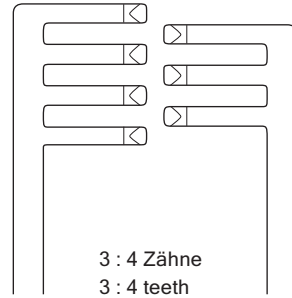

scharf sharp      stumpf blunt      halbscharf semi-sharp

|               |            |            |            |
|---------------|------------|------------|------------|
| 13 cm - 5"    | ER 4700-13 | ER 4701-13 | ER 4702-13 |
| 16,5 cm - 6½" | ER 4700-16 | ER 4701-16 | ER 4702-16 |



WEITLANER

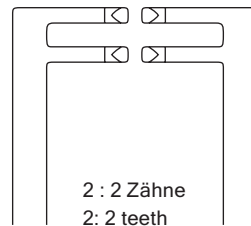

scharf sharp

14 cm - 5½"

ER 4709-20

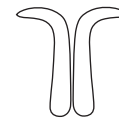

MOLLISON

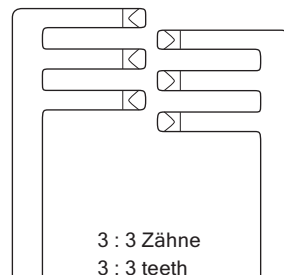

scharf sharp      stumpf blunt

|            |                                     |            |            |
|------------|-------------------------------------|------------|------------|
| 13 cm - 5" | Spreizweite: 45 mm<br>Spread: 45 mm | ER 4710-13 | ER 4711-13 |
|------------|-------------------------------------|------------|------------|



WEITLANER-WULLSTEIN

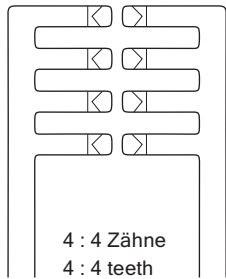

4 : 4 Zähne  
4 : 4 teeth

scharf  
sharp

15 cm - 6"

ER 4714-15



MOLLISON

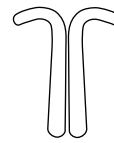

stumpf  
blunt

14 cm - 5½"

ER 4715-14



CLOWARD



2 : 2 Zähne  
2 : 2 teeth

stumpf  
blunt

17 cm - 6¾"

ER 4755-17

MAYO-ADAMS

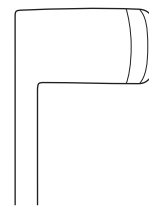

stumpf  
blunt

16 cm - 6¼"

ER 4716-16



TÜBINGER MODELL



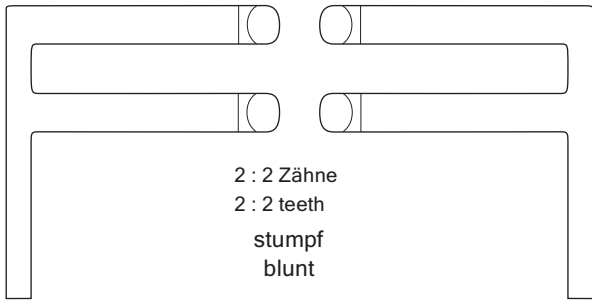

2 : 2 Zähne  
2 : 2 teeth  
stumpf  
blunt

17 cm - 6¾"

ER 4756-17

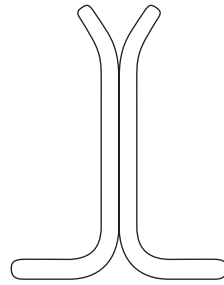

scharf  
sharp

Wundsperrer komplett, bestehend aus:  
Retractor complete, consisting of:

ER 4718-00

Sperrer  
Retractor

3 Mittelvalven (ER 4718-19, -25, -32)  
3 Central blades (ER 4718-19, -25, -32)



MAYO-ADAMS



HENLEY

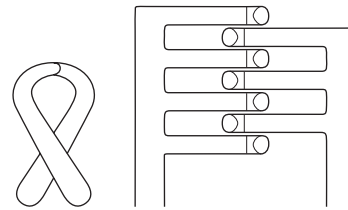

stumpf  
blunt

Wundsperrerr komplett, bestehend aus:  
Retractor complete, consisting of:

ER 4718-01

Sperrer  
Retractor

3 Mittelvalven (ER 4718-19, -25, -32)

3 Central blades (ER 4718-19, -25, -32)



Mittelvalven  
Central blades

|            |            |            |
|------------|------------|------------|
| 19 x 16 mm | 25 x 16 mm | 32 x 16 mm |
| ER 4718-19 | ER 4718-25 | ER 4718-32 |



15 cm - 6"  
ER 6250-15

LABORDE



14 cm - 5½"  
ER 6251-14

TROUSSEAU

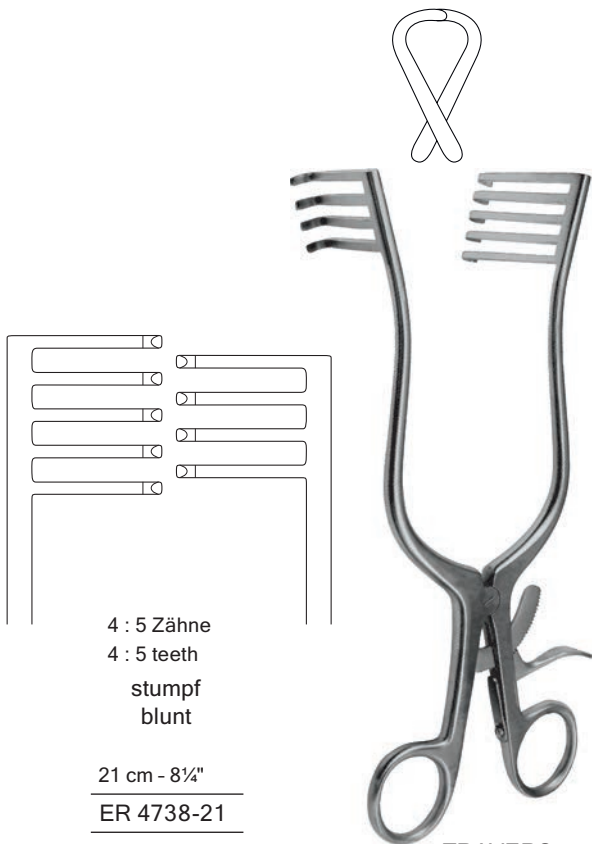

4 : 5 Zähne  
4 : 5 teeth  
stumpf  
blunt

21 cm - 8¼"  
ER 4738-21

TRAVERS

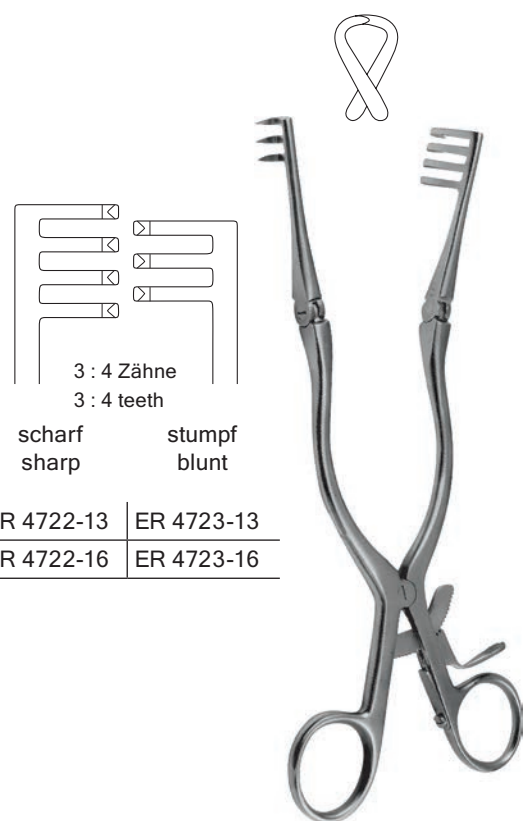

3 : 4 Zähne  
3 : 4 teeth  
scharf  
sharp      stumpf  
blunt

|             |            |            |
|-------------|------------|------------|
| 14 cm - 5½" | ER 4722-13 | ER 4723-13 |
| 16 cm - 6¼" | ER 4722-16 | ER 4723-16 |

CONE (ADSON-BABY)



WEITLANER

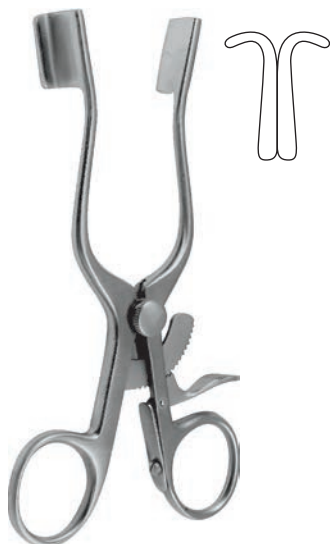
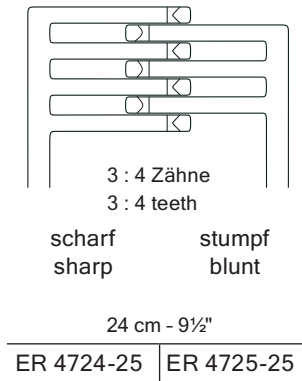
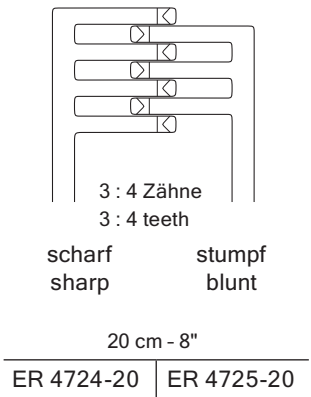

WEITLANER-BABY

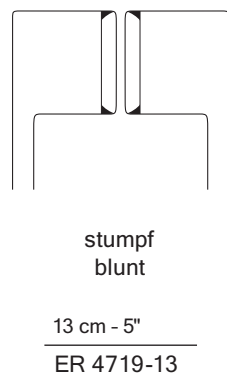

WEITLANER

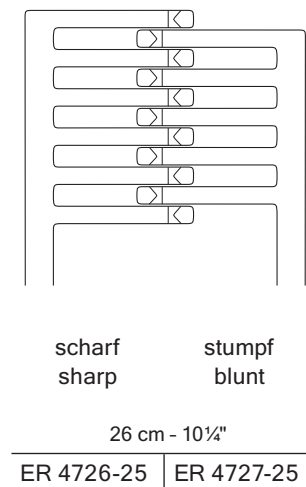

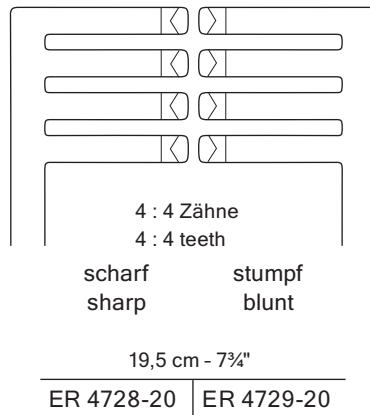

ADSON

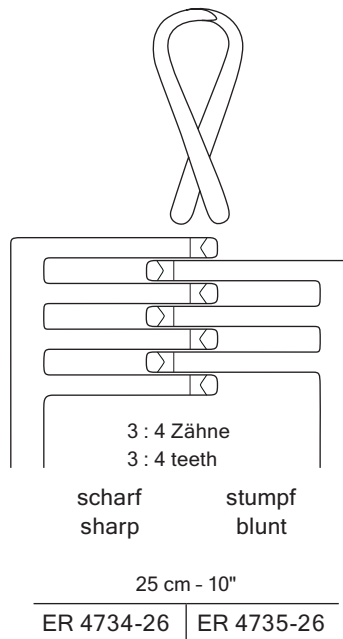
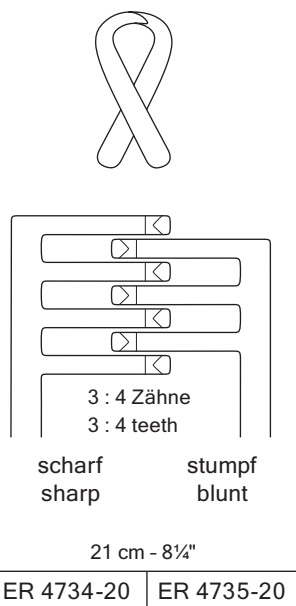

CONE



## Wundspreizer Self-retaining Retractors



NORFOLK AND NORWICH  
22 cm - 8 3/4"  
ER 4744-00

stumpf  
blunt



ADSON

30 cm - 13"  
ER 4739-11



Thyreoid- und Vulvaspreizer  
Thyroid- and vaginal retractor



15,5 cm - 6"  
ER 4761-00

JOLL (FRIEDMANN)

Haut- und Vulvaspreizer  
Skin- and vaginal retractor



GELPI

|                  |            |
|------------------|------------|
| 9,5 cm - 3 3/4"  | ER 4761-09 |
| 12 cm - 4 3/4"   | ER 4761-11 |
| 13,5 cm - 5 1/4" | ER 4761-13 |
| 19 cm - 7 1/2"   | ER 4761-19 |

Haut- und  
Vulvaspreizer  
Skin- and  
vaginal retractor



GELPI

18,5 cm - 7 1/2"  
ER 4763-19





Sperrer allein,  
Spreizweite: 100 mm  
Retractor only,  
spread: 100 mm

23 cm - 9"

Bauchdeckenhalter komplett mit  
einem Paar Blätter ER 4750-51  
Abdominal retractor complete with  
one pair of blades ER 4750-51

ER 4750-00

Blätter seitlich, 1 Paar (38 x 60 mm)  
Blades lateral, 1 pair (38 x 60 mm)

ER 4750-51



18 cm - 7"

Bauchdeckenhalter (Spreizweite: 80 mm) komplett mit  
2 Paar Blätter (35 x 42 mm, 18 x 42 mm)  
Abdominal retractor (spread: 80 mm) complete with  
two pairs of blades (35 x 42 mm, 18 x 42 mm)

ER 4751-00







Fig. 1

|   |            |
|---|------------|
| Sperrer allein,<br>Spreizweite: 110 mm<br>Retractor only,<br>spread: 110 mm   |            |
| Bauchdeckenhalter komplett, bestehend aus:<br>Abdominal retractor complete, consisting of:  | ER 4752-00 |
| Sperrer allein (ER 4752-50)<br>Retractor only (ER 4752-50)<br>1 Paar Blätter seitlich, 38 x 60 mm (ER 4752-51)<br>1 pair of blades lateral, 38 x 60 mm (ER 4752-51)<br>1 Mittelblatt, 38 x 55 mm (ER 4752-55)<br>1 Central blade, 38 x 55 mm (ER 4752-55) |            |

Fig. 2

|   |            |
|---|------------|
| Sperrer allein,<br>Spreizweite: 110 mm<br>Retractor only,<br>spread: 110 mm   | ER 4754-50 |
| Bauchdeckenhalter komplett, bestehend aus:<br>Abdominal retractor complete, consisting of:  | ER 4754-00 |
| Sperrer allein (ER 4754-50)<br>Retractor only (ER 4754-50)<br>1 Paar Blätter seitlich, 38 x 80 mm (ER 4754-51)<br>1 pair of blades lateral, 38 x 80 mm (ER 4754-51)<br>1 Mittelblatt, 50 x 75 mm (ER 4754-65)<br>1 Central blade, 50 x 75 mm (ER 4754-65) |            |



|   |            |
|---|------------|
| Sperrer allein<br>Retractor only  | ER 4754-76 |
| Bauchdeckenhalter komplett, bestehend aus:<br>Abdominal retractor complete, consisting of:            | ER 4754-70 |
| Sperrer allein (ER 4754-76)<br>Retractor only (ER 4754-76)  |            |
| 1 Paar Blätter seitlich, 60 x 80 mm (ER 4754-71)<br>1 pair of blades lateral, 60 x 80 mm (ER 4754-71) |            |
| 1 Mittelblatt, 62 x 67 mm (ER 4754-75)<br>1 Central blade, 62 x 67 mm (ER 4754-75)                    |            |



Fig. 1

|   |            |
|---|------------|
| Sperrer allein<br>Retractor only  | ER 4758-11 |
| Bauchdeckenhalter komplett, bestehend aus:<br>Abdominal retractor complete, consisting of:            | ER 4758-01 |
| Sperrer allein (ER 4758-11)<br>Retractor only (ER 4758-11)  |            |
| 1 Paar Blätter seitlich, 60 x 80 mm (ER 4758-21)<br>1 pair of blades lateral, 60 x 80 mm (ER 4758-21) |            |
| 1 Mittelblatt, 53 x 70 mm (ER 4758-31)<br>1 Central blade, 53 x 70 mm (ER 4758-31)                    |            |

Fig. 2

|   |            |
|---|------------|
| Sperrer allein<br>Retractor only  | ER 4758-11 |
| Bauchdeckenhalter komplett, bestehend aus:<br>Abdominal retractor complete, consisting of:            | ER 4758-02 |
| Sperrer allein (ER 4758-11)<br>Retractor only (ER 4758-11)  |            |
| 1 Paar Blätter seitlich, 72 x 85 mm (ER 4758-22)<br>1 pair of blades lateral, 72 x 85 mm (ER 4758-22) |            |
| 1 Mittelblatt, 80 x 90 mm (ER 4758-32)<br>1 Central blade, 80 x 90 mm (ER 4758-32)                    |            |



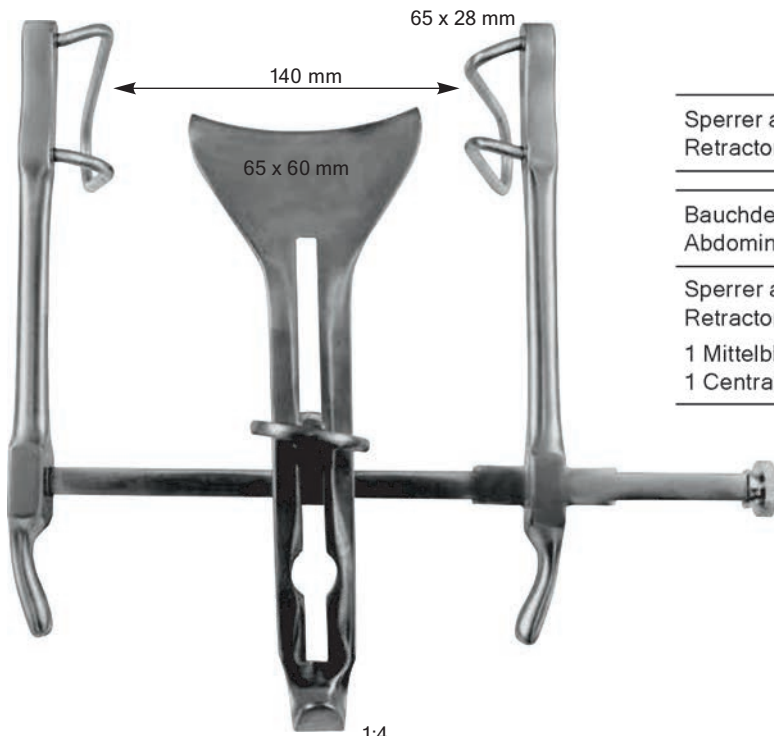

1:4  
GOSSET

|                                  |            |
|----------------------------------|------------|
| Sperrer allein<br>Retractor only | ER 4771-11 |
|----------------------------------|------------|

|  |            |
|--|------------|
| Bauchdeckenhalter komplett, bestehend aus:<br>Abdominal retractor complete, consisting of: | ER 4771-00 |
|--|------------|

|  |
|--|
| Sperrer allein (ER 4771-11)<br>Retractor only (ER 4771-11)                         |
| 1 Mittelblatt, 65 x 57 mm (ER 4771-21)<br>1 Central blade, 65 x 57 mm (ER 4771-21) |

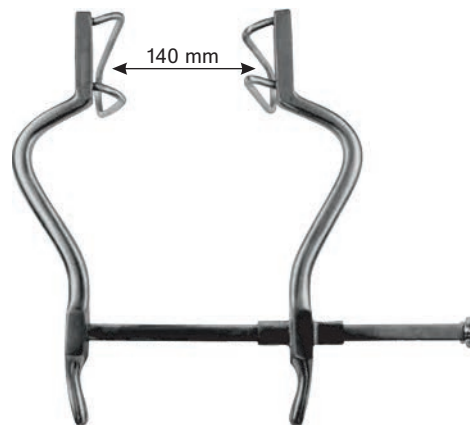

1:4  
GOSSET  
ER 4770-02



1:4  
GOSSET  
ER 4769-00



#### BABY-BALFOUR

|  |            |
|--|------------|
| Sperrer allein,<br>Spreizweite: 95 mm<br>Retractor only,<br>Spread: 95 mm  | ER 4798-11 |
| Sperrer komplett, bestehend aus:<br>Retractor complete, consisting of:   | ER 4798-00 |
| Sperrer allein (ER 4798-11)<br>Retractor only (ER 4798-11)<br>Mittelblatt (ER 4798-21)<br>Central blade (ER 4798-21) |            |



#### BALFOUR

|  |            |
|--|------------|
| Sperrer allein,<br>Spreizweite: 180 mm<br>Retractor only,<br>Spread: 180 mm  | ER 4800-11 |
| Sperrer komplett, bestehend aus:<br>Retractor complete, consisting of:   | ER 4800-00 |
| Sperrer allein (ER 4800-11)<br>Retractor only (ER 4800-11)<br>Mittelblatt (ER 4800-21)<br>Central blade (ER 4800-21) |            |

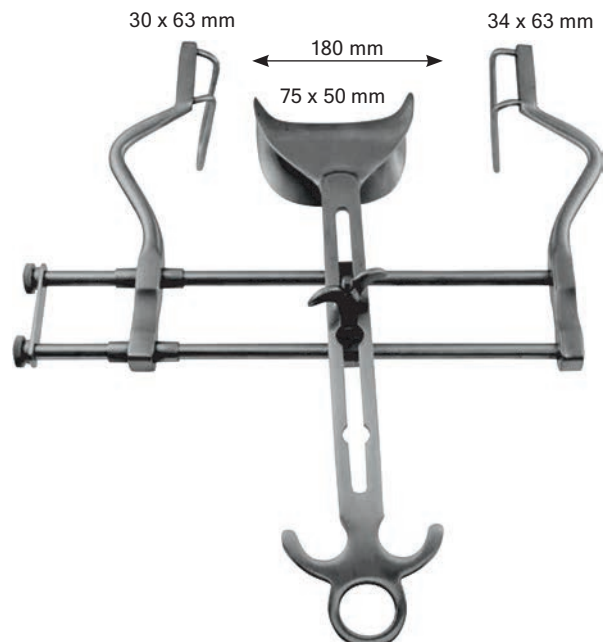



### BALFOUR

Sperrer allein,  
Spreizweite: 180 mm  
Retractor only,  
spread: 180 mm

ER 4802-11

Sperrer komplett, bestehend aus:  
Retractor complete, consisting of:

ER 4802-00

Sperrer allein (ER 4802-11)  
Retractor only (ER 4802-11)  
Mittelblatt (ER 4802-21)  
Central blade (ER 4802-21)



### BALFOUR

Sperrer allein,  
Spreizweite: 250 mm  
Retractor only,  
spread: 250 mm

ER 4804-11

Sperrer komplett, bestehend aus:  
Retractor complete, consisting of:

ER 4804-00

Sperrer allein (ER 4804-11)  
Retractor only (ER 4804-11)  
Mittelblatt (ER 4804-21)  
Central blade (ER 4804-21)





#### BALFOUR

|   |            |
|---|------------|
| Sperrer allein,<br>Spreizweite: 180 mm<br>Retractor only,<br>Spread: 180 mm | ER 4806-11 |
|---|------------|

|  |            |
|--|------------|
| Sperrer komplett, bestehend aus:<br>Retractor complete, consisting of: | ER 4806-00 |
|--|------------|

Sperrer allein (ER 4806-11)  
Retractor only (ER 4806-11)  
Mittelblatt (ER 4806-21)  
Central blade (ER 4806-21)



#### BALFOUR USA-MODELL

|                                  |            |
|----------------------------------|------------|
| Sperrer allein<br>Retractor only | ER 4807-11 |
|----------------------------------|------------|

|  |            |
|--|------------|
| Sperrer komplett, bestehend aus:<br>Retractor complete, consisting of: | ER 4807-00 |
|--|------------|

Sperrer allein (ER 4807-11)  
Retractor only (ER 4807-11)  
2 Blätter seitlich, 57 mm (ER 4807-31)  
2 Blades lateral, 57 mm (ER 4807-31)  
2 Blätter seitlich, 90 mm (ER 4807-32)  
2 Blades lateral, 90 mm (ER 4807-32)  
1 Mittelblatt, 68 x 40 mm (ER 4807-21)  
1 Central blade, 68 x 40 mm (ER 4807-21)  
1 Mittelblatt, 85 x 70 mm (ER 4807-22)  
1 Central blade, 85 x 70 mm (ER 4807-22)





### SEMM

|  |            |
|--|------------|
| Bauchdeckenhalter komplett,<br>bestehend aus:<br>Abdominal retractor complete,<br>consisting of: | ER 4810-00 |
|--|------------|

- Rahmen (ER 4810-10)
- Frame (ER 4810-10)
- 2 Blätter (ER 4810-01)
- 2 Blades (ER 4810-01)
- 1 Blätter (ER 4810-02)
- 1 Blades (ER 4810-02)
- 1 Blätter (ER 4810-03)
- 1 Blades (ER 4810-03)
- 1 Blätter (ER 4810-04)
- 1 Blades (ER 4810-04)
- 1 Blätter (ER 4810-05)
- 1 Blades (ER 4810-05)



Rahmen fest  
Solid frame  
255 x 220 mm  
ER 4810-10

1:3



47 x 65 mm  
ER 4810-01

1:3



56 x 56 mm  
ER 4810-02

1:3



80 x 98 mm  
ER 4810-03

1:3



97 x 52 mm  
ER 4810-04

1:3



105 x 36 mm  
ER 4810-05

1:3



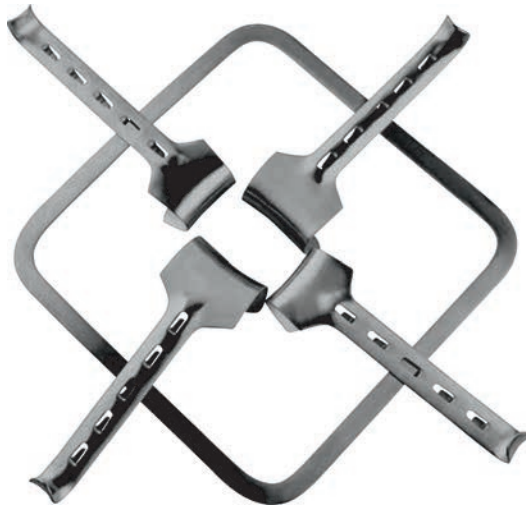

1:4

#### KIRSCHNER

Bauchdeckenhalter komplett, bestehend aus:  
Abdominal retractor complete, consisting of:

ER 4820-00

Rahmen fest (ER 4820-10)  
Solid frame (ER 4820-10)

2 Blätter, 40 x 55 mm (ER 4822-01)  
2 Blades, 40 x 55 mm (ER 4822-01)

2 Blätter, 50 x 65 mm (ER 4822-02)  
2 Blades, 50 x 65 mm (ER 4822-02)

#### KIRSCHNER

Bauchdeckenhalter komplett, bestehend aus:  
Abdominal retractor complete, consisting of:

ER 4821-00

Rahmen zusammenlegbar (ER 4821-10)  
Foldable frame (ER 4821-10)

2 Blätter, 40 x 55 mm (ER 4822-01)  
2 Blades, 40 x 55 mm (ER 4822-01)

2 Blätter, 50 x 65 mm (ER 4822-02)  
2 Blades, 50 x 65 mm (ER 4822-02)



1:4



1:3



|             | Blätter<br>Blades |
|-------------|-------------------|
| 40 x 55 mm  | ER 4822-01        |
| 50 x 65 mm  | ER 4822-02        |
| 80 x 90 mm  | ER 4822-04        |
| 98 x 50 mm  | ER 4822-05        |
| 105 x 35 mm | ER 4822-06        |



Rahmen  
Frame

178 x 140 mm

ER 4826-10

### DENIS-BROWN

|  |            |
|--|------------|
| Bauchdeckenhalter komplett, bestehend aus:<br>Abdominal retractor complete, consisting of: | ER 4826-00 |
|--|------------|

|  |
|--|
| Rahmen 178 x 140 mm (ER 4826-10)<br>Frame 178 x 140 mm (ER 4826-10)                    |
| 2 Blätter, Fig. 1, 40 x 40 mm (ER 4828-01)<br>2 Blades, ig. 1, 40 x 40 mm (ER 4828-01) |
| 2 Blätter, Fig. 2, 40 x 30 mm (ER 4828-02)<br>2 Blades, ig. 2, 40 x 30 mm (ER 4828-02) |



Blatt, Fig. 2  
Blade, ig. 2

1:3 40 x 30 mm

ER 4828-02



Blatt, Fig. 1  
Blade, ig. 1

1:3 40 x 40 mm

ER 4828-01



Rahmen  
Frame

255 x 178 mm

ER 4827-10

### DENIS-BROWN

|  |            |
|--|------------|
| Bauchdeckenhalter komplett, bestehend aus:<br>Abdominal retractor complete, consisting of: | ER 4827-00 |
|--|------------|

|  |
|--|
| Rahmen 255 x 178 mm (ER 4827-10)<br>Frame 255 x 178 mm (ER 4827-10)                    |
| 2 Blätter, Fig. 1, 40 x 40 mm (ER 4828-01)<br>2 Blades, ig. 1, 40 x 40 mm (ER 4828-01) |
| 2 Blätter, Fig. 2, 40 x 30 mm (ER 4828-02)<br>2 Blades, ig. 2, 40 x 30 mm (ER 4828-02) |



Blatt, Fig. 1  
Blade, ig. 1

1:3 40 x 40 mm

ER 4828-01



Blatt, Fig. 2  
Blade, ig. 2

1:3 40 x 30 mm

ER 4828-02



#### O'SULLIVAN-O'CONNOR

Bauchdeckenhalter komplett, bestehend aus:  
Abdominal retractor complete, consisting of: **ER 4829-00**

2 Mittelblätter, 90 x 45 mm (ER 4829-22)  
2 Central blades, 90 x 45 mm (ER 4829-22)

1 Mittelblatt, 90 x 70 mm (ER 4829-23)  
1 Central blade, 90 x 70 mm (ER 4829-23)

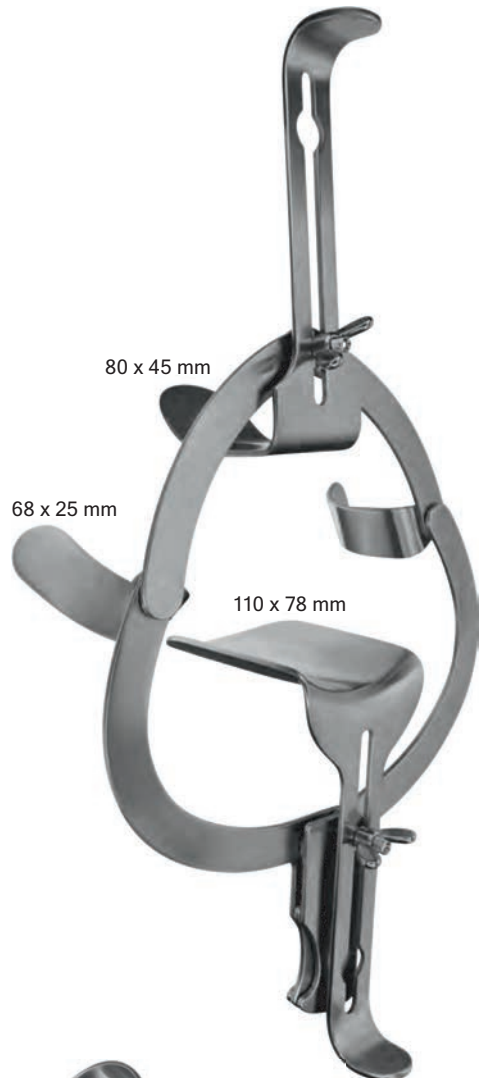

90 x 45 mm  
**ER 4829-22**

100 x 70 mm  
**ER 4829-23**

|             |            |
|-------------|------------|
| 50 x 90 mm  | ER 4834-01 |
| 50 x 105 mm | ER 4834-02 |
| 50 x 120 mm | ER 4834-03 |
| 50 x 135 mm | ER 4834-04 |



Bauchdeckenhalter  
Abdominal retractor

1:3  
**DOYEN**

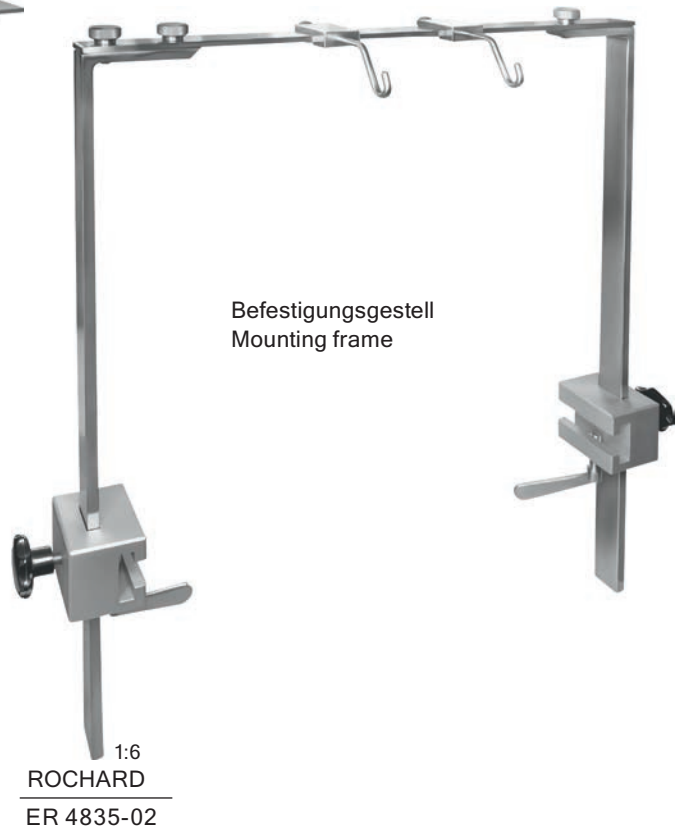

|             | Blätter<br>Blades |
|-------------|-------------------|
| 50 x 90 mm  | ER 4835-09        |
| 50 x 105 mm | ER 4835-10        |
| 50 x 120 mm | ER 4835-12        |
| 55 x 135 mm | ER 4835-13        |
| 50 x 155 mm | ER 4835-15        |



**Trokare, Saug- und Spülinstrumente,  
Sonden, Watteträger**  
*Trocars, Suction and Irrigation Instruments,  
Probes, Cotton Applicators*



**Trokare / Trocars**

**Kanülen / Cannulas**

**Saug-Raspatorien, Saug-Dissektoren / Suction Raspatories, Suction Dissectors**

**Mikro-Saugkanülen / Micro Suction Tubes**

**Katheterzangen / Catheter Forceps**

**Spritzen / Syringes**

**Luer-Lock Adapter / Luer-Lock Adapter**

**Führungsnadeln / Guide Needles**

**Sonden / Probes**

**Watteträger / Cotton Applicators**

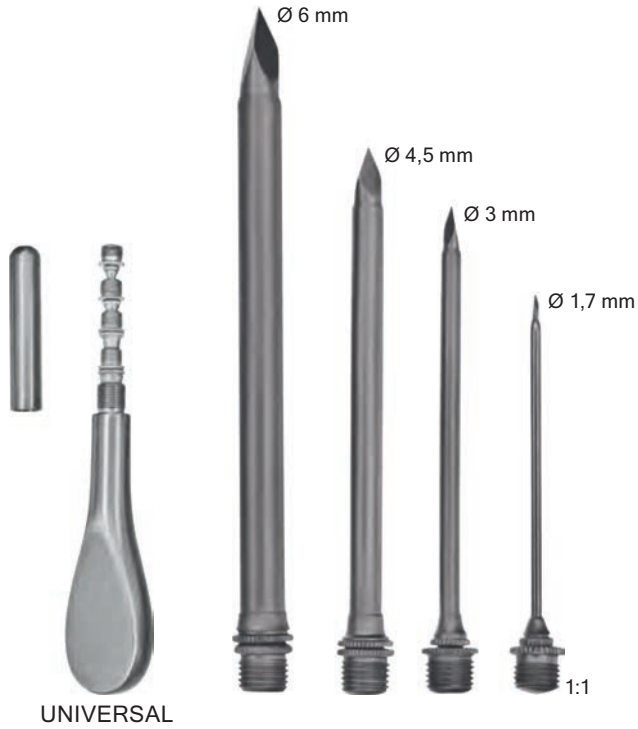

|                                     |            |
|-------------------------------------|------------|
| Trokar-Set komplett, bestehend aus: | ER 5212-04 |
| Trocar set complete, consisting of: |            |

- 1 Griff, lach
- 1 Handle, lat
- 1 Trokar Ø 1,7 mm
- 1 Trocar Ø 1.7 mm
- 1 Trokar Ø 3 mm
- 1 Trocar Ø 3 mm
- 1 Trokar Ø 4,5 mm
- 1 Trocar Ø 4.5 mm
- 1 Trokar Ø 6 mm
- 1 Trocar Ø 6 mm



Ø 10 mm mit zentraler Bohrung Ø 2 mm  
 Ø 10 mm with central bore Ø 2 mm



27 cm - 10½"  
 ER 5260-27

1:3  
 YANKAUER-STANDARD

Ø 5 mm



22,5 cm - 8¾"  
 ER 5265-00

ANDREW-PYNCHON

Ø 1,8 x 35 mm



1:1  
 KLIMA-ROSEGGER

Ø 10 mm

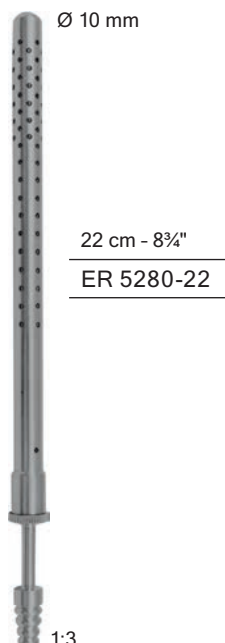

22 cm - 8¾"  
 ER 5280-22

1:3  
 POOLE

Ø 8 mm



22 cm - 8¾"  
 ER 5281-22

1:3  
 POOLE

| FRAZIER<br>(FERGUSSON) |            | Arbeitslänge<br>Working length |
|------------------------|------------|--------------------------------|
| Ø mm                   | Charr./Fr. | 110 mm - 4¼"                   |
| 1,5                    | 5          | ER 6420-16                     |
| 2                      | 6          | ER 6420-17                     |
| 2,3                    | 7          | ER 6420-18                     |
| 2,5                    | 8          | ER 6420-19                     |
| 3                      | 9          | ER 6420-20                     |
| 3,3                    | 10         | ER 6420-21                     |
| 3,5                    | 11         | ER 6420-22                     |
| 4                      | 12         | ER 6420-23                     |
| 5                      | 15         | ER 6420-24                     |



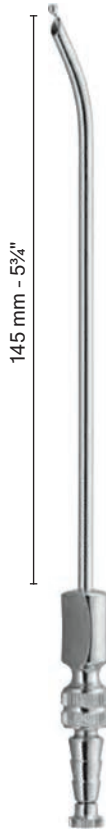

|      |            | Arbeitslänge<br>Working length |
|------|------------|--------------------------------|
| Ø mm | Charr./Fr. | 145 mm - 5 3/4"                |
| 4    | 12         | ER 6426-21                     |

ADSON



|      |            | Arbeitslänge<br>Working length |
|------|------------|--------------------------------|
| Ø mm | Charr./Fr. | 120 mm - 4"                    |
| 2,3  | 7          | ER 6424-20                     |
| 3    | 9          | ER 6424-21                     |
| 3,5  | 11         | ER 6424-22                     |

FRAZIER



Olive  
Olive  
Ø 8 mm

|      |            | Arbeitslänge<br>Working length |
|------|------------|--------------------------------|
| Ø mm | Charr./Fr. | 70 mm - 2 3/4"                 |
| 1    | 3          | ER 7845-03                     |
| 1,5  | 5          | ER 7845-05                     |
| 2,3  | 7          | ER 7845-07                     |

BARON



Nadelsauger  
Suction needle

Olive  
Olive  
Ø 8 mm

|      |        | Arbeitslänge<br>Working length |
|------|--------|--------------------------------|
| Ø mm | Gauges | 80 mm - 3 1/4"                 |
| 0,9  | 20     | ER 7845-20                     |
| 0,7  | 22     | ER 7845-22                     |
| 0,5  | 24     | ER 7845-24                     |

SCHUKNECHT



MAGILL



für Kleinkinder  
for infants

15 cm - 6"

ER 5295-15



für Kinder  
for children

20 cm - 8"

ER 5295-20



für Erwachsene  
for adults

25 cm - 10"

ER 5295-25

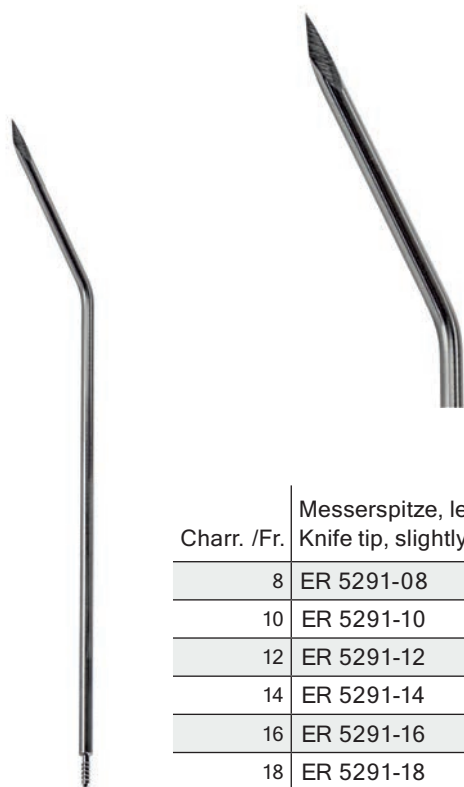

REDON

| Charr. /Fr. | Messerspitze, leicht gebogen<br>Knife tip, slightly curved |
|-------------|--|
| 8           | ER 5291-08   |
| 10          | ER 5291-10   |
| 12          | ER 5291-12   |
| 14          | ER 5291-14   |
| 16          | ER 5291-16   |
| 18          | ER 5291-18   |

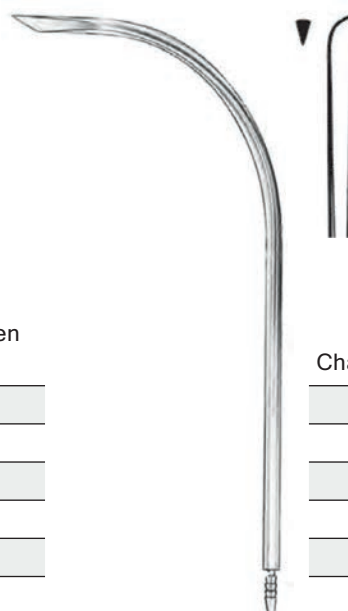

REDON

| Charr. /Fr. | Messerspitze, gebogen<br>Knife tip, curved |
|-------------|--|
| 8           | ER 5291-28                                 |
| 10          | ER 5291-30                                 |
| 12          | ER 5291-32                                 |
| 14          | ER 5291-34                                 |
| 16          | ER 5291-36                                 |
| 18          | ER 5291-38                                 |



REDON

| Charr. /Fr. | Lanzettenspitze, leicht gebogen<br>Lancet tip, slightly curved |
|-------------|--|
| 8           | ER 5291-48   |
| 10          | ER 5291-50   |
| 12          | ER 5291-52   |
| 14          | ER 5291-54   |
| 16          | ER 5291-56   |
| 18          | ER 5291-58   |



Doppelknopfsonde  
Double-ended Probe

|               | Ø 1 mm     | Ø 1,5 mm   | Ø 2 mm     |
|---------------|------------|------------|------------|
| 11,5 cm - 4½" | ER 4900-11 |            |            |
| 13 cm - 5"    | ER 4900-13 | ER 4901-13 | ER 4902-13 |
| 14,5 cm - 5¾" | ER 4900-14 | ER 4901-14 | ER 4902-14 |
| 16 cm - 6¼"   | ER 4900-16 | ER 4901-16 | ER 4902-16 |
| 18 cm - 7"    | ER 4900-18 | ER 4901-18 | ER 4902-18 |
| 20 cm - 8"    | ER 4900-20 | ER 4901-20 | ER 4902-20 |
| 25 cm - 10"   |            | ER 4901-25 | ER 4902-25 |



| Ø 2 mm        | Öhrsonde<br>Probe with eye |
|---------------|----------------------------|
| 11,5 cm - 4½" | ER 4906-11                 |
| 13 cm - 5"    | ER 4906-13                 |
| 14,5 cm - 5¾" | ER 4906-14                 |
| 16 cm - 6¼"   | ER 4906-16                 |
| 18 cm - 7"    | ER 4906-18                 |
| 20 cm - 8"    | ER 4906-20                 |



|               | Hohlsonde<br>Director |
|---------------|-----------------------|
| 11,5 cm - 4½" | ER 4910-11            |
| 13 cm - 5"    | ER 4910-13            |
| 14,5 cm - 5¾" | ER 4910-14            |
| 16 cm - 6¼"   | ER 4910-16            |
| 18 cm - 7"    | ER 4910-18            |
| 20 cm - 8"    | ER 4910-20            |



Sonde, gebogen  
Probe, curved

|               |
|---------------|
| 14,5 cm - 5¾" |
| ER 4911-14    |



DOYEN



|               | Hohlsonde<br>Director |
|---------------|-----------------------|
| 13 cm - 5"    | ER 4912-13            |
| 14,5 cm - 5¾" | ER 4912-14            |
| 16 cm - 6¼"   | ER 4912-16            |
| 18 cm - 7"    | ER 4912-18            |

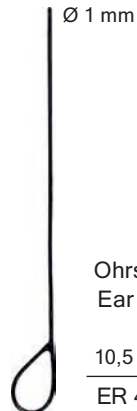

|               |            |
|---------------|------------|
| 10,5 cm - 4¼" | ER 4916-10 |
|---------------|------------|

STACKE



|               | Myrtenblattsonde<br>Myrtle leaf probe |
|---------------|---------------------------------------|
| 13 cm - 5"    | ER 4914-13                            |
| 14,5 cm - 5¾" | ER 4914-14                            |
| 16 cm - 6¼"   | ER 4914-16                            |
| 20 cm - 8"    | ER 4914-20                            |



|             |            |
|-------------|------------|
| 16 cm - 6¼" | ER 4915-16 |
|-------------|------------|

NELATON



|            |            |
|------------|------------|
| 20 cm - 8" | ER 4917-18 |
|------------|------------|

BRODIE

Rektal-Hohlsonde  
Rectal probe

geknöpfte Spitze  
ball end



Fistelsonde  
Fistula probe

gerade  
straight

gebogen 45°  
curved 45°

stark gebogen 90°  
strongly curved 90°

retrograd gebogen  
retrograde curved

17 cm - 6¾"

|            |            |            |            |
|------------|------------|------------|------------|
| Fig. 1     | Fig. 2     | Fig. 3     | Fig. 4     |
| ER 4925-01 | ER 4925-02 | ER 4925-03 | ER 4925-04 |

LOCKART-MUMMARY

Fistelsonde  
Fistula probe

enge Biegung  
narrow hook

kurzer Haken  
short hook

langer Haken  
long hook

21 cm - 8¼"

|            |            |            |
|------------|------------|------------|
| ER 4926-01 | ER 4926-02 | ER 4926-03 |
|------------|------------|------------|

PRATT



spiralförmig gerieft  
spiral threads



28 cm - 11"  
ER 4922-28

FEIN

doppelendig  
double-ended



18 cm - 7"  
ER 4933-02

JOBSON-HORNE



FARRELL



|               | Ø mm<br>Ø mm | rund gerieft<br>round serrated | dreikant gerieft<br>triangular serrated |
|---------------|--------------|--------------------------------|---|
| 14 cm - 5½"   | 0,9          | ER 4935-14                     | ER 4936-14                              |
| 16,5 cm - 6½" | 1,1          | ER 4935-16                     | ER 4936-16                              |





## Wundverschluß Woundclosure



**Nadelhalter-Proil** / *Suture Forceps Tread*

**Mikro-Nadelhalter** / *Micro Suture Forceps*

**Nadelhalter** / *Suture Forceps*

**Unterbindungsnadeln** / *Ligature Needles*

**Reverdinnadeln** / *Reverdin Needles*

**Führungshohlsonden** / *Guiding Probes*

**Wundklammern** / *Suture Clips*

**Klammeranlegepinzetten** / *Clip Applying Forceps*

**Chirurgisches Taschenbesteck** / *Pocket Instrument Set*

**Venae Sectio Besteck** / *Venae Secito Set*

**Verband** / *Cast*



## Nadelhalter-Profil Suture Forceps Tread

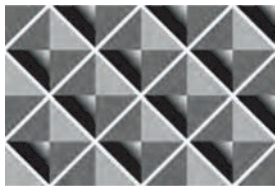

0,5 mm  
für Nadeln und Nahtmaterial  
bis Stärke 3/0  
  
2500 tpsi (teeth per square inch)  
for needles and suturing material  
with thickness up to 3/0

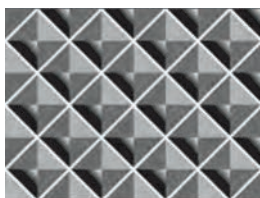

0,4 mm  
für feine Nadeln und Nahtmaterial,  
Stärke 4/0 – 6/0  
  
3600 tpsi (teeth per square inch)  
for delicate needles and suturing  
material with thickness up to 4/0 - 6/0

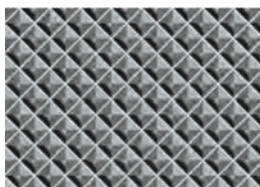

0,3 mm  
für feine Nadeln und Nahtmaterial  
bis Stärke 8/0  
  
7000 tpsi (teeth per square inch)  
for delicate needles and suturing  
material with thickness up to 8/0

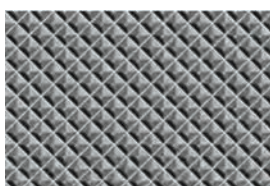

0,2 mm  
für feinste Nadeln und Nahtmaterial,  
Stärke 6/0 – 10/0  
  
14400 tpsi (teeth per square inch)  
for delicate needles and suturing  
material, thickness 6/0 – 10/0



**MICROGRIP**  
für extrem feines Nahtmaterial,  
Stärke 6/0 – 11/0  
  
for extremely delicate suturing material,  
thickness 6/0 – 11/0



Glatt,  
für extrem feines Nahtmaterial,  
Stärke 6/0 – 11/0  
  
Smooth,  
for extremely delicate suturing material,  
thickness 6/0 – 11/0



gerade  
straight

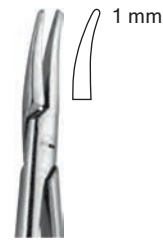

gebogen  
curved

|            | mit Sperre<br>with ratchet | ohne Sperre<br>without ratchet | mit Sperre<br>with ratchet | ohne Sperre<br>without ratchet |
|------------|----------------------------|--------------------------------|----------------------------|--------------------------------|
| 15 cm - 6" | ER 5852-15                 | ER 5850-15                     | ER 5853-15                 | ER 5851-15                     |



gerade  
straight



gebogen  
curved

diamantbeschichtet  
diamond coated

|        |               | mit Sperre<br>with ratchet | ohne Sperre<br>without ratchet | mit Sperre<br>with ratchet | ohne Sperre<br>without ratchet |
|--------|---------------|----------------------------|--------------------------------|----------------------------|--------------------------------|
| 1 mm   | 12 cm - 4¾"   | ER 5864-12                 | ER 5860-12                     | ER 5865-12                 | ER 5861-12                     |
| 1 mm   | 14,5 cm - 5¾" | ER 5864-15                 | ER 5860-15                     | ER 5865-15                 | ER 5861-15                     |
| 1 mm   | 18 cm - 7"    | ER 5864-18                 | ER 5860-18                     | ER 5865-18                 | ER 5861-18                     |
| 1,2 mm | 21 cm - 8¼"   | ER 5864-21                 | ER 5860-21                     | ER 5865-21                 | ER 5861-21                     |
| 1,2 mm | 23 cm - 9"    | ER 5864-23                 | ER 5860-23                     | ER 5865-23                 | ER 5861-23                     |





## Mikro-Nadelhalter Micro Suture Forceps



diamantbeschichtet  
diamond coated

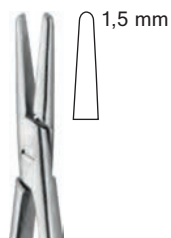

1,5 mm

gerade  
straight

|             | mit Sperre<br>with ratchet | ohne Sperre<br>without ratchet |
|-------------|----------------------------|--------------------------------|
| 18 cm - 7"  | ER 5854-36                 | ER 5854-39                     |
| 21 cm - 8¼" | ER 5854-46                 | ER 5854-49                     |

JACOBSON



Körnung 0,4 mm  
Grit 3600 tpsi

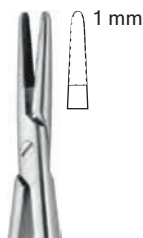

1 mm

gerade  
straight

|               | Typ<br>Type | mit Sperre<br>with ratchet |
|---------------|-------------|----------------------------|
| 18 cm - 7"    | TC          | ER 5930-32                 |
| 20 cm - 8"    | TC          | ER 5930-42                 |
| 22,5 cm - 8¾" | TC          | ER 5930-52                 |

JACOBSON

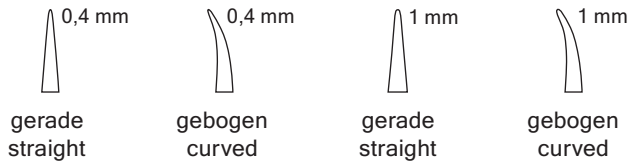

|             | Typ<br>Type | mit Sperre<br>with ratchet |             | mit Sperre<br>with ratchet |             |
|-------------|-------------|----------------------------|-------------|----------------------------|-------------|
| 18 cm - 7"  | TI          | ER 5862-34T                | ER 5862-35T | ER 5862-38T                | ER 5862-39T |
| 21 cm - 8¼" | TI          | ER 5862-44T                | ER 5862-45T | ER 5862-48T                | ER 5862-49T |



Körnung 0,3 mm  
Grit 7000 tpsi

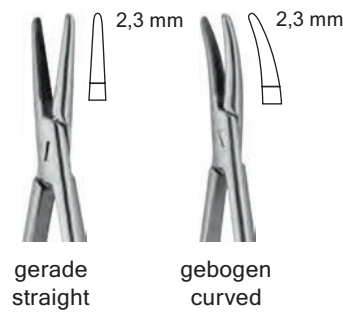

|             | Typ<br>Type | mit Sperre<br>with ratchet |                 |
|-------------|-------------|----------------------------|-----------------|
|             |             | Körnung<br>Grit            | Körnung<br>Grit |
| 14 cm - 5½" | TC          | ER 5931-12                 | ER 5931-13      |
| 18 cm - 7"  | TC          | ER 5931-32                 | ER 5931-33      |
| 21 cm - 8¼" | TC          | ER 5931-42                 | ER 5931-43      |



CASTROVIEJO



## Mikro-Nadelhalter Micro Suture Forceps



Körnung 0,2 mm  
Grit 14400 tpsi



gerade  
straight

2,0 mm



gebogen  
curved

2,0 mm

|               | Typ<br>Type | mit Sperre<br>with ratchet | ohne Sperre<br>without ratchet | mit Sperre<br>with ratchet | ohne Sperre<br>without ratchet |
|---------------|-------------|----------------------------|--------------------------------|----------------------------|--------------------------------|
| 14,5 cm - 5¾" | TC          | ER 5866-12                 | ER 5866-14                     | ER 5866-13                 | ER 5866-15                     |
| 18 cm - 7"    | TC          | ER 5866-32                 | ER 5866-34                     | ER 5866-33                 | ER 5866-35                     |
| 21 cm - 8¼"   | TC          | ER 5866-42                 | ER 5866-44                     | ER 5866-43                 | ER 5866-45                     |
| 23 cm - 9"    | TC          | ER 5866-52                 | ER 5866-54                     | ER 5866-53                 | ER 5866-55                     |

CASTROVIEJO/BARRAQUER



CASTROVIEJO



gerade  
straight

0,75 mm



gebogen  
curved

0,75 mm

|            | mit Sperre<br>with ratchet | ohne Sperre<br>without ratchet | mit Sperre<br>with ratchet | ohne Sperre<br>without ratchet |
|------------|----------------------------|--------------------------------|----------------------------|--------------------------------|
| 9 cm - 3½" | ER 5958-09                 | ER 5956-09                     | ER 5959-09                 | ER 5957-09                     |



gerade  
straight



gebogen  
curved

|             | mit Sperre<br>with ratchet | ohne Sperre<br>without ratchet | mit Sperre<br>with ratchet | ohne Sperre<br>without ratchet |
|-------------|----------------------------|--------------------------------|----------------------------|--------------------------------|
| 14 cm - 5½" | ER 5958-14                 | ER 5956-14                     | ER 5959-14                 | ER 5957-14                     |



CASTROVIEJO

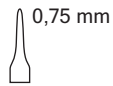

gerade  
straight



gebogen  
curved

|            | mit Sperre<br>with ratchet | ohne Sperre<br>without ratchet | mit Sperre<br>with ratchet | ohne Sperre<br>without ratchet |
|------------|----------------------------|--------------------------------|----------------------------|--------------------------------|
| 13 cm - 5" | ER 5976-10                 | ER 5974-10                     | ER 5977-10                 | ER 5975-10                     |



BARRAQUER-TROUTMAN



gerade,  
mit Sperre  
straight,  
with ratchet

14 cm - 5½"  
ER 5986-14



KALT



gerade,  
mit Sperre  
straight,  
with ratchet

13,5 cm - 5¼"  
ER 5987-14



CASTROVIEJO-KALT





## Nadelhalter Suture Forceps



HALSEY

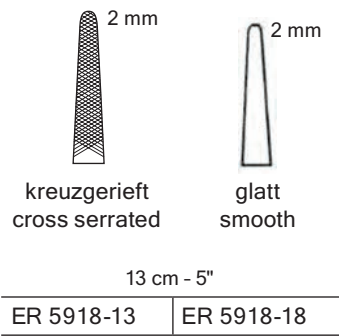

WEBSTER



DERF



NEW ORLEANS



HEGAR-BAUMGARTNER

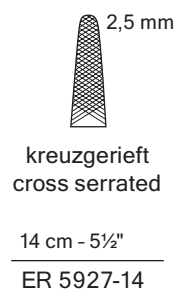

BROWN

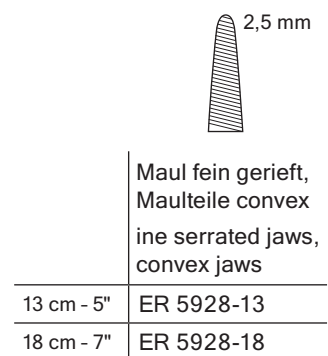

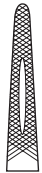

gekerbt  
slotted

|               |            |
|---------------|------------|
| 18,5 cm - 7¼" | ER 6006-18 |
| 26 cm - 10¼"  | ER 6006-26 |



HEANEY



gekerbt  
slotted

gerade  
straight

|              |            |
|--------------|------------|
| 14 cm - 5½"  | ER 6000-14 |
| 16 cm - 6¼"  | ER 6000-16 |
| 18 cm - 7"   | ER 6000-18 |
| 20 cm - 8"   | ER 6000-20 |
| 24 cm - 9½"  | ER 6000-24 |
| 26 cm - 10¼" | ER 6000-26 |
| 30 cm - 11¼" | ER 6000-30 |



MAYO-HEGAR



3 mm

gebogen  
curved

|             |            |
|-------------|------------|
| 21 cm - 8¼" | ER 6002-21 |
|-------------|------------|



HEANEY



2,5 mm

gekerbt  
slotted

|             |            |
|-------------|------------|
| 16 cm - 6¼" | ER 6003-16 |
| 18 cm - 7"  | ER 6003-18 |
| 20 cm - 8"  | ER 6003-20 |

schlankes Modell  
delicate pattern



MAYO-HEGAR



## Nadelhalter Suture Forceps



kräftiges Modell  
heavy pattern

HEGAR

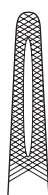

gekerbt  
slotted



kreuzgerieft  
cross serrated

|             |            |            |
|-------------|------------|------------|
| 16 cm - 6¼" | ER 6004-16 | -          |
| 18 cm - 7"  | ER 6004-18 | -          |
| 20 cm - 8"  | ER 6004-20 | ER 6004-21 |



CRILE-WOOD

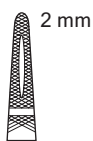

gekerbt  
slotted

15 cm - 6"  
ER 6012-15



CRILE-MURRAY

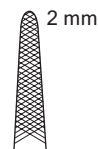

15 cm - 6"  
ER 6014-15

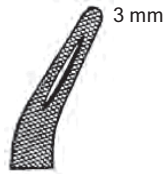

3 mm

gekerbt  
slotted

27 cm - 10½"

ER 6007-27



FINOCCHIETTO 1:3



3,5 mm

gekerbt  
slotted

26,5 cm - 10½"

ER 6008-27



MASSON 1:3



2,5 mm

23,5 cm - 9¼"

ER 6009-23



JAMESON 1:3

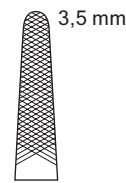

3,5 mm

27 cm - 10½"

ER 6010-27



WAGENSTEEN 1:3



Nadelhalter  
Suture Forceps



ADSON

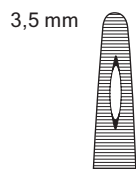

3,5 mm  
gefenestert  
fenestrated

18 cm - 7"

ER 6016-18



OLSEN-HEGAR



3 mm  
gekerbt  
slotted

14 cm - 5½"

ER 6030-14

18 cm - 7"

ER 6030-18



OLSEN-HEGAR

Körnung 0,5 mm  
Grit 2500 tpsi



GILLIES

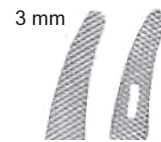

3 mm  
gefenestert  
fenestrated

16 cm - 6¼"

ER 6032-16

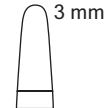

|            |             |             |               |
|------------|-------------|-------------|---------------|
| Typ / Type | 14 cm - 5½" | 17 cm - 6¾" | 18,5 cm - 7¼" |
| TC         | ER 6080-14  | ER 6080-17  | ER 6080-18    |



Körnung 0,4 mm  
Grit 3600 tpsi

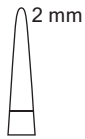

|            |            |
|------------|------------|
| Typ / Type | 13 cm - 5" |
| TC         | ER 6045-13 |



NEIVERT

Körnung 0,5 mm  
Grit 2500 tpsi

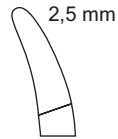

|            |             |
|------------|-------------|
| Typ / Type | 16 cm - 6¼" |
| TC         | ER 6081-16  |



GILLIES

Körnung 0,4 mm  
Grit 3600 tpsi

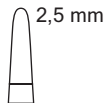

|            |              |
|------------|--------------|
| Typ / Type | 12,5 cm - 5" |
| TC         | ER 6047-12   |



DERF



glatt  
smooth

|            |            |
|------------|------------|
| Typ / Type | 13 cm - 5" |
| TC         | ER 6046-13 |



WEBSTER

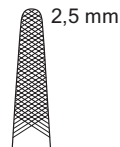

kreuzgerieft  
cross serrated

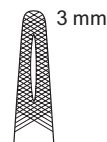

gekerbt  
with groove

|             |            |            |
|-------------|------------|------------|
| 14 cm - 5½" | ER 6040-14 | ER 6042-14 |
| 17 cm - 6¾" | ER 6040-17 | ER 6042-17 |
| 20 cm - 8"  | ER 6040-20 | ER 6042-20 |



MATHIEU





## Nadelhalter Suture Forceps

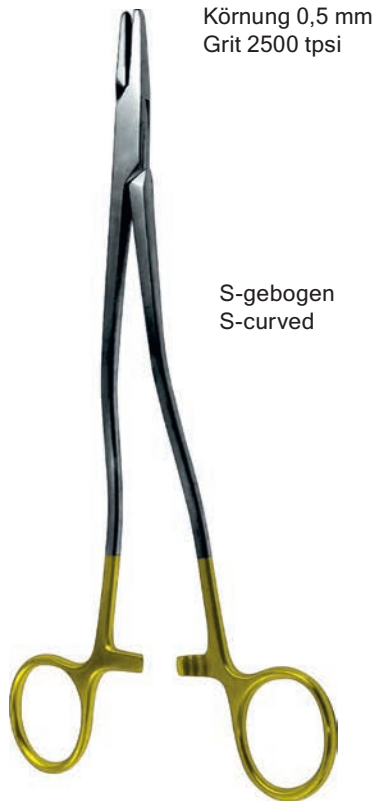

Körnung 0,5 mm  
Grit 2500 tpsi

S-gebogen  
S-curved

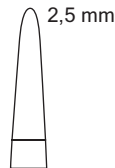

| Typ / Type |              |            |
|------------|--------------|------------|
| TC         | 20 cm - 8"   | ER 6049-20 |
| TC         | 24 cm - 9½"  | ER 6049-24 |
| TC         | 26 cm - 10¼" | ER 6049-26 |

BOZEMANN



Körnung 0,5 mm  
Grit 2500 tpsi

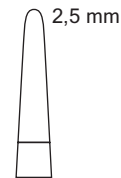
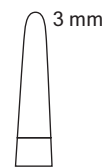
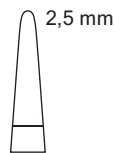

| Typ / Type | 16 cm - 6¼" | 18 cm - 7" | 20 cm - 8" |
|------------|-------------|------------|------------|
| TC         | ER 6050-16  | ER 6050-18 | ER 6050-20 |

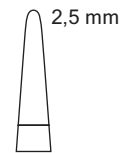

Linkshänder  
Left-handed

| Typ / Type | 16 cm - 6¼" |
|------------|-------------|
| TC         | ER 6050-16L |

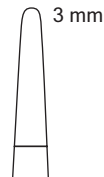
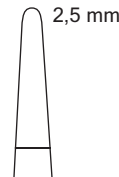
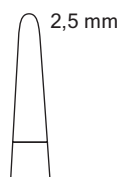

| Typ / Type | 24 cm - 9½" | 26 cm - 10¼" | 30 cm - 11¼" |
|------------|-------------|--------------|--------------|
| TC         | ER 6050-24  | ER 6050-26   | ER 6050-30   |

MAYO-HEGAR





Körnung 0,5 mm  
Grit 2500 tpsi

kräftiges Modell  
heavy pattern

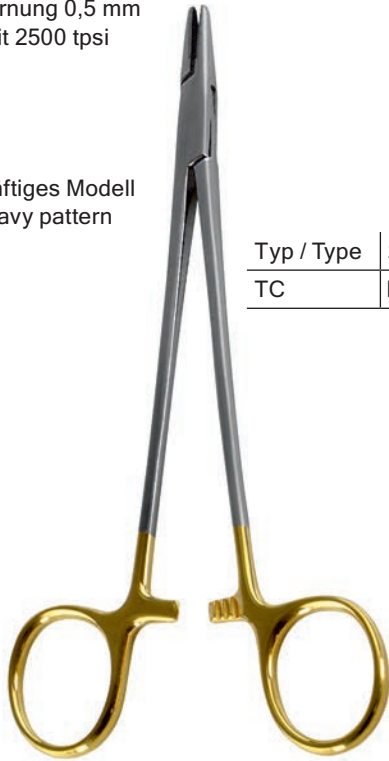

MAYO-HEGAR

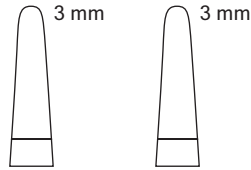

|            |            |             |
|------------|------------|-------------|
| Typ / Type | 20 cm - 8" | 24 cm - 9½" |
| TC         | ER 6053-20 | ER 6053-24  |

Körnung 0,5 mm  
Grit 2500 tpsi



HEGAR-BAUMGARTNER

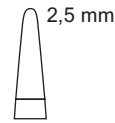

|            |             |
|------------|-------------|
| Typ / Type | 14 cm - 5½" |
| TC         | ER 6052-14  |

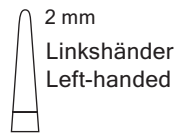
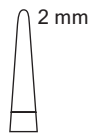

|            |            |             |
|------------|------------|-------------|
| Typ / Type | 15 cm - 6" |             |
| TC         | ER 6055-15 | ER 6055-15L |

Körnung 0,4 mm  
Grit 3600 tpsi



CRILE-WOOD



|            |            |
|------------|------------|
| Typ / Type | 15 cm - 6" |
| TC         | ER 6055-35 |



## Nadelhalter Suture Forceps



DE BAKEY

Körnung 0,3 mm  
Grit 7000 tpsi

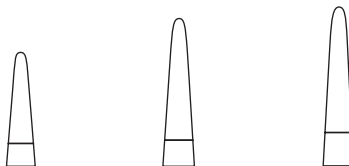

|            |            |            |            |
|------------|------------|------------|------------|
| Typ / Type | 15 cm - 6" | 18 cm - 7" | 20 cm - 8" |
| TC         | ER 6054-40 | ER 6054-18 | ER 6054-20 |

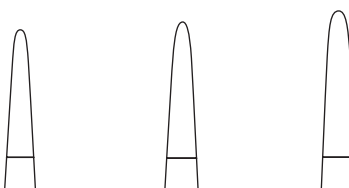

|            |            |                |               |
|------------|------------|----------------|---------------|
| Typ / Type | 23 cm - 9" | 26,5 cm - 10½" | 30,5 cm - 12" |
| TC         | ER 6054-23 | ER 6054-26     | ER 6054-31    |



CRILE-WOOD

Körnung 0,4 mm  
Grit 3600 tpsi



|            |            |
|------------|------------|
| Typ / Type | 18 cm - 7" |
| TC         | ER 6055-18 |

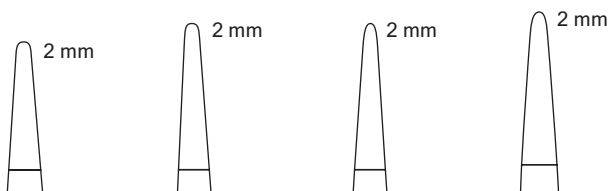

|            |            |            |              |              |
|------------|------------|------------|--------------|--------------|
| Typ / Type | 20 cm - 8" | 23 cm - 9" | 26 cm - 10¼" | 31 cm - 12¼" |
| TC         | ER 6055-20 | ER 6055-23 | ER 6055-26   | ER 6055-31   |



Körnung 0,2 mm  
Grit 14400 tpsi

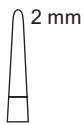

|            |              |
|------------|--------------|
| Typ / Type | 12,5 cm - 5" |
| TC         | ER 6057-12   |

CONVERSE

Körnung 0,4 mm  
Grit 3600 tpsi

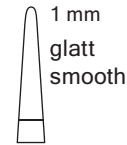

|            |            |
|------------|------------|
| Typ / Type | 13 cm - 5" |
| TC         | ER 6056-33 |

HALSEY

Körnung 0,2 mm  
Grit 14400 tpsi

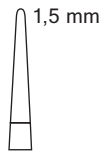

|             | Typ | Type       | gerade<br>straight |
|-------------|-----|------------|--------------------|
| 14 cm - 5½" | TC  | ER 6059-39 |                    |
| 18 cm - 7"  | TC  | ER 6059-40 |                    |
| 20 cm - 8"  | TC  | ER 6059-41 |                    |
| 23 cm - 9"  | TC  | ER 6059-42 |                    |

HEGAR-VASCULAR

Körnung 0,4 mm  
Grit 3600 tpsi

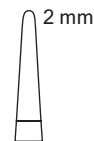

|            |               |
|------------|---------------|
| Typ / Type | 13,5 cm - 5¼" |
| TC         | ER 6058-13    |

KILNER



Nadelhalter  
Suture Forceps



Körnung 0,4 mm  
Grit 3600 tpsi

RYDER

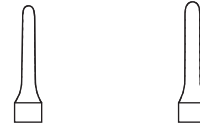

| Typ / Type | 13 cm - 5" | 15 cm - 6" |
|------------|------------|------------|
| TC         | ER 6059-13 | ER 6059-16 |



| Typ / Type | 18 cm - 7" |
|------------|------------|
| TC         | ER 6059-18 |

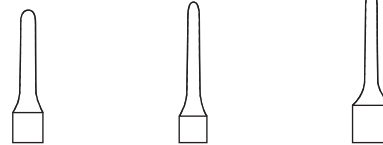

| Typ / Type | 20 cm - 8" | 23 cm - 9" | 25 cm - 10" |
|------------|------------|------------|-------------|
| TC         | ER 6059-20 | ER 6059-23 | ER 6059-26  |



Körnung 0,2 mm  
Grit 14400 tpsi

MICRO-RYDER

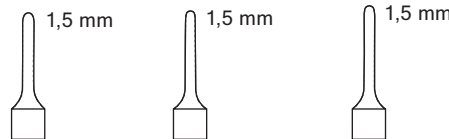

| Typ / Type | 13 cm - 5" | 15 cm - 6" | 18 cm - 7" |
|------------|------------|------------|------------|
| TC         | ER 6059-63 | ER 6059-65 | ER 6059-68 |

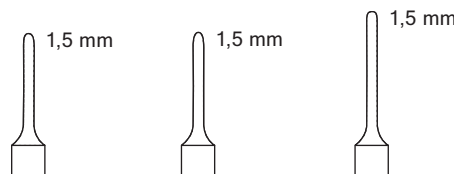

| Typ / Type | 20 cm - 8" | 23 cm - 9" | 26 cm - 10¼" |
|------------|------------|------------|--------------|
| TC         | ER 6059-70 | ER 6059-73 | ER 6059-76   |



Körnung 0,4 mm  
Grit 3600 tpsi



3 mm

|            |            |
|------------|------------|
| Typ / Type | 23 cm - 9" |
| TC         | ER 6061-23 |

STRATTE

Körnung 0,5 mm  
Grit 2500 tpsi

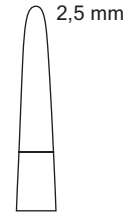

2,5 mm

|            |              |
|------------|--------------|
| Typ / Type | 27 cm - 10½" |
| TC         | ER 6063-27   |

WAGENSTEEN 1:3

Körnung 0,5 mm  
Grit 2500 tpsi

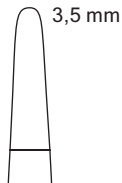

3,5 mm

|            |              |
|------------|--------------|
| Typ / Type | 27 cm - 10½" |
| TC         | ER 6062-27   |

MASSON 1:3

Körnung 0,5 mm  
Grit 2500 tpsi

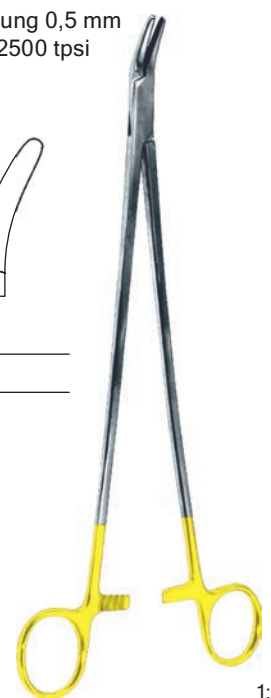

3,5 mm

|            |              |
|------------|--------------|
| Typ / Type | 27 cm - 10½" |
| TC         | ER 6064-27   |

FINOCCHIETTO 1:3



## Nadelhalter Suture Forceps



Körnung 0,4 mm  
Grit 3600 tpsi

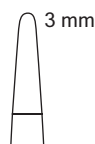

| Typ / Type | 18 cm - 7" | 26 cm - 10¼" |
|------------|------------|--------------|
| TC         | ER 6060-18 | ER 6060-26   |

SAROT



Körnung 0,4 mm  
Grit 3600 tpsi

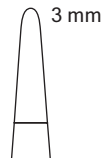
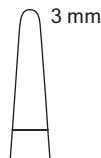
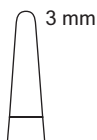

| Typ / Type | 14 cm - 5½" | 17 cm - 6¾" | 20 cm - 8" |
|------------|-------------|-------------|------------|
| TC         | ER 6065-14  | ER 6065-17  | ER 6065-20 |

MATHIEU



rechts  
right

13 cm - 5"

ER 6118-15



KRONECKER

links  
left

13 cm - 5"

ER 6119-15



KRONECKER

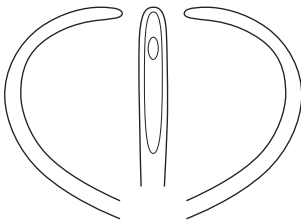

rechts  
right

links  
left

rechts, stumpf  
right, blunt

links, stumpf  
left, blunt

20 cm - 8"

ER 6100-20 | ER 6102-20

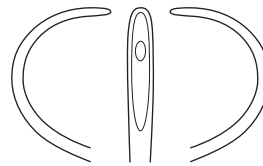

rechts  
right

links  
left

rechts, stumpf  
right, blunt

links, stumpf  
left, blunt

20 cm - 8"

ER 6108-01 | ER 6108-02

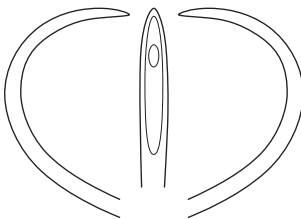

rechts, scharf  
right, sharp

links, scharf  
left, sharp

20 cm - 8"

ER 6104-20 | ER 6106-20

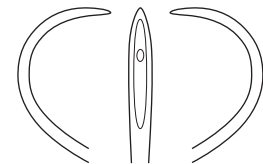

rechts, scharf  
right, sharp

links, scharf  
left, sharp

20 cm - 8"

ER 6108-03 | ER 6108-04



DESCHAMPS-STANDARD



DESCHAMPS-STANDARD





## Unterbindungsnadeln Ligature Needles

rechts right      links left

rechts, scharf      links, scharf  
right, sharp      left, sharp

21 cm - 8 1/4"

|            |            |
|------------|------------|
| ER 6114-21 | ER 6116-21 |
|------------|------------|

rechts, stumpf      links, stumpf  
right, blunt      left, blunt

21 cm - 8 1/4"

|            |            |
|------------|------------|
| ER 6110-21 | ER 6112-21 |
|------------|------------|

DESCHAMPS

rechts right      links left

rechts, stumpf, steile Biegung      links, stumpf, steile Biegung  
right, blunt, steep turn      left, blunt, steep turn

22,5 cm - 8 3/4"

|            |            |
|------------|------------|
| ER 6105-01 | ER 6105-02 |
|------------|------------|

DESCHAMPS

rechts right      links left

rechts, stumpf, steile Biegung      links, stumpf, steile Biegung  
right, blunt, steep turn      left, blunt, steep turn

28 cm - 11"

|            |            |
|------------|------------|
| ER 6110-24 | ER 6112-24 |
|------------|------------|

DESCHAMPS

rechts right      links left

rechts, stumpf, steile Biegung      links, stumpf, steile Biegung  
right, blunt, steep turn      left, blunt, steep turn

22,5 cm - 8 3/4"

|            |            |
|------------|------------|
| ER 6105-03 | ER 6105-04 |
|------------|------------|

DESCHAMPS



biegsam  
malleable

21 cm - 8 1/4"

ER 6123-20



18,5 cm - 7 1/4"

ER 6124-19



COOPER

### Reverdin Nadeln Reverdin Needles



Fig. 3



Fig. 4

22,5 cm - 8 3/4"

ER 6128-03

ER 6128-04



Fig. 1



Fig. 2

22,5 cm - 8 3/4"

ER 6128-01

ER 6128-02



REVERDIN

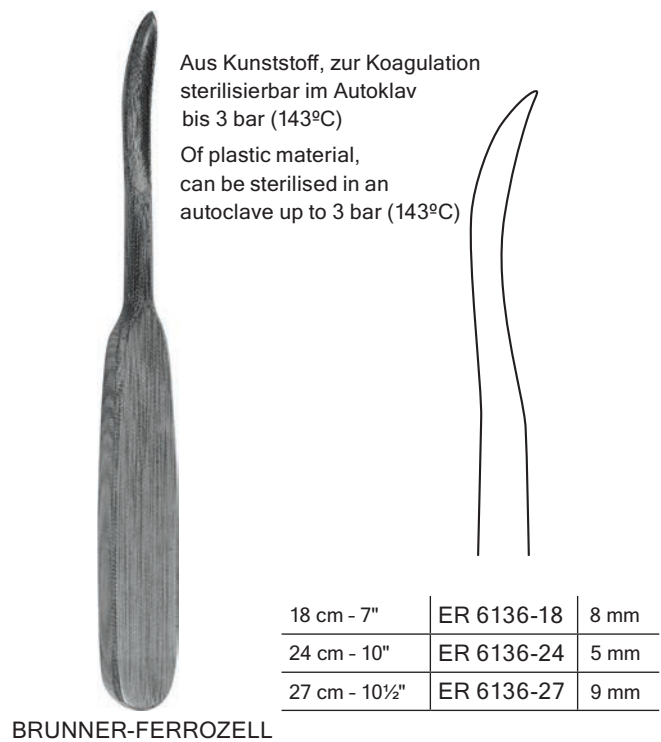
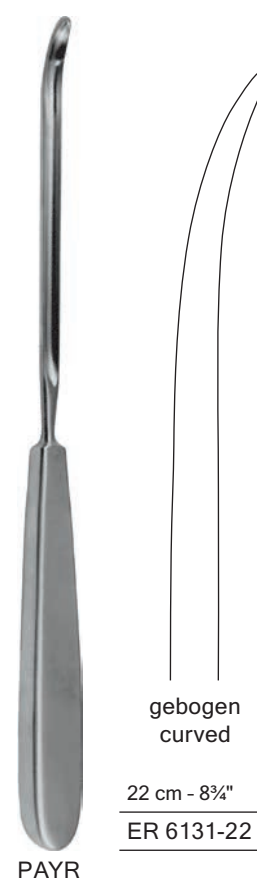
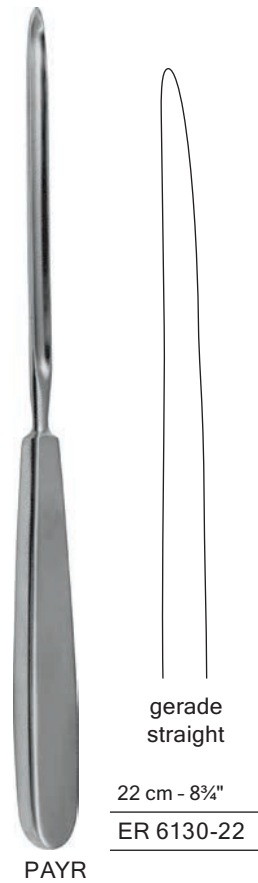
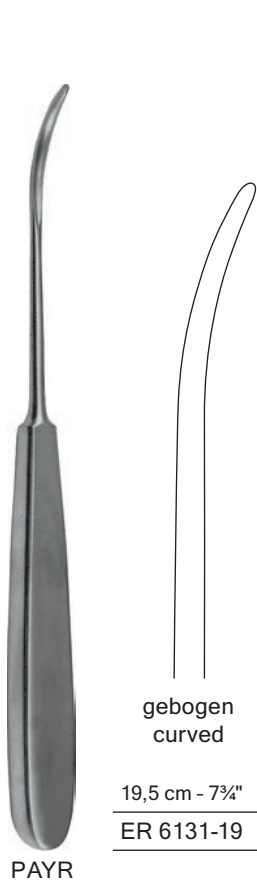



3 mm



19,5 cm - 7 3/4"  
ER 6141-19



KÖNIG

5 mm



19,5 cm - 7 3/4"  
ER 6142-19



KÖNIG



20 cm - 8"  
ER 6143-20



KÖNIG

Fadengabel  
Knottier



23 cm - 9"  
ER 6147-23

Fadenfänger  
Suture hook



1:3  
MOD. WIEN

8 mm



23,5 cm - 9 1/4"  
ER 6145-23



## Wundklammern Suture Clips



MICHEL

Klammeranlege- und  
Entfernungszange  
Clip applying and  
removing forceps

12 cm - 4¾"

ER 6150-12



MICHEL MOD.

Klammeranlege- und  
Entfernungszange  
Clip applying and  
removing forceps

12,5 cm - 5"

ER 6151-12



COLLIN

Klammeranlege- und  
Entfernungszange  
Clip applying and  
removing forceps

13 cm - 5"

ER 6152-13



RICHTER-HEATH

14 cm - 5½"

ER 6153-14

## Klammeranlegepinzetten Clip Applying Forceps



MICHEL

12 cm - 4¾"

ER 6164-12



HEGENBARTH

12,5 cm - 5"

ER 6168-12

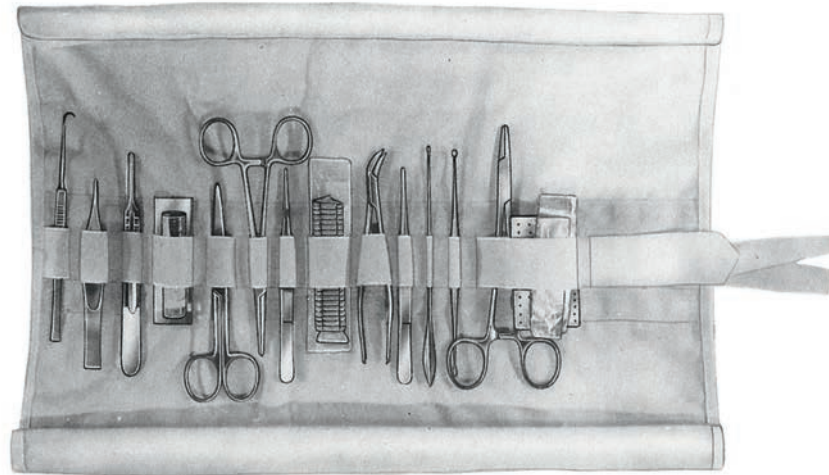

Chirurgisches Taschenbesteck komplett, bestehend aus:  
Pocket instrument set complete, consisting of:

- 1 Arterienklemme Crile, 14 cm - 5½", gerade (ER 3074-14)
- 1 Hemostatic forceps, 14 cm - 5½", straight (ER 3074-14)
- 1 Häkchen Bergmann, 14 cm - 5½", scharf (ER 4469-14)
- 1 Hook Bergmann, 14 cm - 5½", sharp (ER 4469-14)
- 1 Skalpellgriff No. 4, 13,5 cm - 5¼" (ER 4850-04)
- 1 Scalpel handle No. 4, 13.5 cm - 5¼" (ER 4850-04)
- 1 Myrtenblattsonde, 13 cm - 5" (ER 4914-13)
- 1 Myrtle blade probe, 13 cm - 5" (ER 4914-13)
- 1 Doppellöffel Williger, 13,5 cm - 5¼", Ø 4,2/3,5 mm, scharf (ER 5368-12)
- 1 Double curette Williger, 13.5 cm - 5¼", Ø 4.2/3.5 mm, sharp (ER 5368-12)
- 1 Nadelhalter Mayo-Hegar, 16 cm - 6¼", gerade (ER 6000-16)
- 1 Needle holder Mayo-Hegar, 16 cm - 6¼", straight (ER 6000-16)
- 1 Nadeldose gelocht, 50 x 25 x 4,5 mm (ER 8910-50)
- 1 Needle case perforated, 50 x 25 x 4.5 mm (ER 8910-50)
- 1 Nadeldose gelocht, 75 x 25 x 4,5 mm (ER 8910-75)
- 1 Needle case perforated, 75 x 25 x 4.5 mm (ER 8910-75)
- 1 Chirurgische Schere, 13 cm - 5", spitz/stumpf, gerade (ER 1002-13)
- 1 Surgical scissors, 13 cm - 5", sharp/blunt, straight (ER 1002-13)
- 1 Anatomische Pinzette Standard, 13 cm - 5", gerade (ER 4000-13)
- 1 Dressing forceps Standard, 13 cm - 5", straight (ER 4000-13)
- 1 Chirurgische Pinzette Standard, 13 cm - 5", 1:2 Zähne, gerade (ER 4100-13)
- 1 Tissue forceps Standard, 13 cm - 5", 1:2 teeth, straight (ER 4100-13)
- 1 Splitterpinzette Feilchenfeld, 11,5 cm - 4½", gerade (ER 4320-11)
- 1 Splinter forceps Feilchenfeld, 11.5 cm - 4½", straight (ER 4320-11)
- 1 Wundklammerzängchen Michel modif., 12,5 cm - 5" (ER 6151-12)
- 1 Clip applying forceps Michel modif., 12,5 cm - 5" (ER 6151-12)
- 1 Rolltasche allein, im Autoklav sterilisierbar (ER 6180-00/01)
- 1 Pocket bag, only, autoclavable (ER 6180-00/01)
- 1 Metalletui (ER 8979-00)
- 1 Metal case, only, (ER 8979-00)



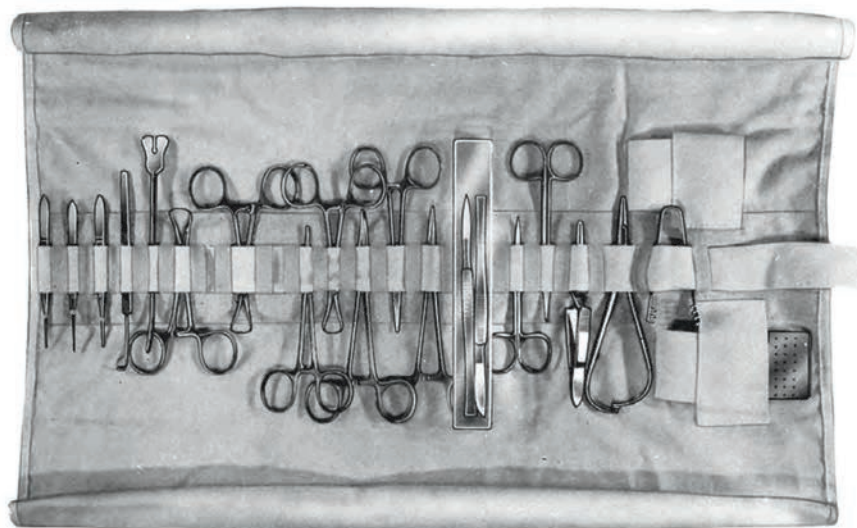

Venae Sectio Besteck komplett, bestehend aus:  
Venae sectio set complete, consisting of:

ER 6185-00

- 1 Schere, 10,5 cm - 4¼", fein, gebogen (ER 1631-10)
- 1 Scissors, 10.5 cm - 4¼", delicate, curved (ER 1631-10)
- 1 Gefäßschere mit Knopf, 11,5 cm - 4½", gerade (ER 1705-11)
- 1 Coronary scissors with ball-end, 11.5 cm - 4½", straight (ER 1705-11)
- 1 Anatomische Pinzette, 10 cm - 4", fein, gerade (ER 4250-10)
- 1 Dressing forceps, 10 cm - 4", delicate, straight (ER 4250-10)
- 1 Chirurgische Pinzette, 10,5 cm - 4¼", fein, gerade, 1:2 Zähne (ER 4260-10)
- 1 Tissue forceps, 10.5 cm - 4¼", delicate, straight, 1:2 teeth (ER 4260-10)
- 1 Wundsperrer Finsen, 7 cm - 2¾", feststellbar, scharf (ER 4642-07)
- 1 Retractor Finsen, 7 cm - 2¾", lockable, sharp (ER 4642-07)
- 1 Hohlsonde Doyen, 14,5 cm - 5¾", gebogen (ER 4911-14)
- 1 Probe Doyen, 14.5 cm - 5¾", curved (ER 4911-14)
- 1 Nadelhalter Mathieu, 14 cm - 5½", gerade (ER 6040-14)
- 1 Needle holder Mathieu, 14 cm - 5½", straight (ER 6040-14)
- 1 Unterbindungsnadel Kronecker, 13 cm - 5", links (ER 6118-15)
- 1 Ligature needle Kronecker, 13 cm - 5", left (ER 6118-15)
- 1 Klammeranlegezange Hegenbarth, 12,5 cm - 5", 2:3 Zähne (ER 6168-12)
- 1 Clip applying forceps Hegenbarth, 12.5 cm - 5", 2:3 teeth (ER 6168-12)
- 1 Chirurgische Pinzette Micro-Adson-Bierner, 12 cm - 4¾", fein, gerade, 1:2 Zähne (ER 4131-12)
- 1 Tissue forceps Micro-Adson-Bierner, 12 cm - 4¾", delicate, straight, 1:2 teeth (ER 4131-12)
- 2 Arterienklemme Halstead-Mosquito, 12,5 cm - 5", gebogen (ER 3101-12)
- 2 Hemostatic forceps Halstead-Mosquito, 12.5 cm - 5", curved (ER 3101-12)
- 2 Arterienklemme Halstead-Mosquito, 12,5 cm - 5", gerade, 1:2 Zähne (ER 3110-12)
- 2 Hemostatic forceps Halstead-Mosquito, 12.5 cm - 5", straight, 1:2 teeth (ER 3110-12)
- 3 Tuchklemme Backhaus, 9 cm - 3½" (ER 3600-09)
- 3 Towel forceps Backhaus, 9 cm - 3½" (ER 3600-09)
- 1 Anatomisches Skalpell, Fig. 1, spitz (ER 4858-01)
- 1 Dissecting Scalpel, Fig. 1, pointed (ER 4858-01)
- 1 Anatomisches Skalpell, Fig. 6, spitz (ER 4858-06)
- 1 Dissecting Scalpel, Fig. 6, pointed (ER 4858-06)
- 1 Nadeldose gelocht, 50 x 25 x 4,5 mm (ER 8910-50)
- 1 Needle case perforated, 50 x 25 x 4.5 mm (ER 8910-50)
- 1 Rolltasche allein, im Autoklav sterilisierbar (ER 6180-00/01)
- 1 Pocket bag, only, autoclavable (ER 6180-00/01)
- 1 Metalletui allein (ER 8979-00)
- 1 Metal case, only, (ER 8979-00)





20 cm - 8"  
ER 6210-20

HOPKINS



18 cm - 7"  
ER 6212-18

ESMARCH



18,5 cm - 7¼"  
ER 6214-18

REINER

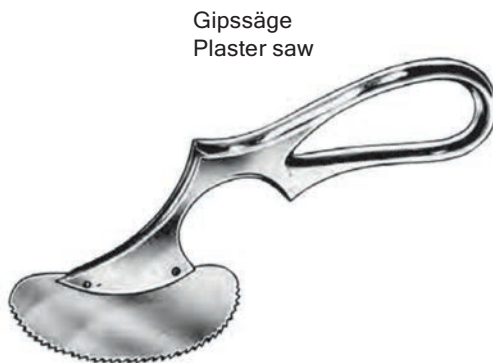

Gipssäge  
Plaster saw

15 cm - 6"  
ER 6225-14

ENGEL



Gipsspreizer  
Plaster spreader

28 cm - 11"  
ER 6230-28

HENNING 1:3



Gipsspreizer  
Plaster spreader

23 cm - 9"  
ER 6234-23

MOD. USA

1:3



Gipsabreißzange  
Plaster breaker

|             |            |
|-------------|------------|
| 18 cm - 7"  | ER 6240-18 |
| 24 cm - 9½" | ER 6240-24 |

WOLFF



Gipsschere  
Plaster shears

24 cm - 9½"  
ER 2835-24

STILLE

1:3



Gipsschere  
Plaster shears

Messer mit verstärktem Rücken  
Blade with reinforced back

|              |            |
|--------------|------------|
| 23 cm - 9"   | ER 2840-23 |
| 26 cm - 10¼" | ER 2840-26 |
| 37 cm - 14½" | ER 2840-37 |

STILLE

1:3



## Abdominale Chirurgie *Abdominal Surgery*

**Darm- und Gewebefasszangen** / *Intestinal and Tissue Grasping Forceps*

**Darmklemmen** / *Intestinal Clamps*

**Magenklemmen** / *Stomach Clamps*

**Magen- und Darmquetschklemmen** / *Intestinal and Pylorus Clamps*

**Magen- und Darm-Zwillingsklemmen** / *Stomach and Intestinal Twin Clamps*

**Anastomosenklemmen** / *Anastomosis Clamps*

**Rektum-Anastomosenklemmen** / *Sigmoid Anastomosis Clamps*

**Rektum-Spekula** / *Rectal Specula*

**Rektoskope** / *Rectoscopes*

**Analspreizer** / *Rectal Spreader*

**Rektum-Biopsiefasszange** / *Rectal Biopsy Forceps*

**Hämorrhoidalzangen** / *Haemorrhoidal Forceps*

**Hämorrhoidal-Ligatoren** / *Haemorrhoidal Ligators*

**Gallenkanal-Klemmzangen** / *Gall Duct Forceps*

**Gallenkanal Instrumente** / *Gall Duct Instruments*

**Nierenklemmen** / *Kidney Clamps*

**Nierensteinzangen** / *Kidney Stone Forceps*

**Blasenwundspreizer** / *Bladder Retractors*

**Urologie-Instrumente** / *Urology Instruments*







Darm- und Gewebefasszangen  
Intestinal and Tissue Grasping Forceps



ALLIS

|             |  4 : 5 Zähne<br>4 : 5 teeth |  5 : 6 Zähne<br>5 : 6 teeth |
|-------------|--|--|
| 15 cm - 6"  | ER 6500-15   | ER 6502-15   |
| 19 cm - 7½" | -  | ER 6502-19   |
| 23 cm - 9"  | -  | ER 6502-23   |
| 25 cm - 10" | -  | ER 6502-25   |



BABY-ALLIS

|             |  4 : 5 Zähne<br>4 : 5 teeth |
|-------------|--|
| 12 cm - 4¾" | ER 6504-12   |
| 14 cm - 5½" | ER 6504-14   |



DE BAKEY Zahnung  
DE BAKEY Serration



|              |            |
|--------------|------------|
| 16 cm – 6¼"  | ER 6505-16 |
| 20 cm – 8"   | ER 6505-20 |
| 22 cm – 8¾"  | ER 6505-22 |
| 25 cm – 10"  | ER 6505-25 |
| 30 cm – 11¾" | ER 6505-30 |



ALLIS-ATRAUMA

10:11 Zähne  
10:11 teeth

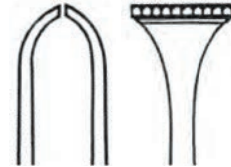

|            |
|------------|
| 15 cm – 6" |
| ER 6506-15 |



ALLIS-ADAIR

5:6 Zähne  
5:6 teeth



|            |
|------------|
| 15 cm – 6" |
| ER 6508-15 |



BOYS-ALLIS

12 mm



|    |             |            |
|----|-------------|------------|
|    | 16 cm – 6¼" | 20 cm – 8" |
| TC | ER 6519-16  | ER 6519-20 |



BABCOCK



JUDD-ALLIS



|             |                            |
|-------------|----------------------------|
|             | 3 : 4 Zähne<br>3 : 4 teeth |
| 15 cm – 6"  | ER 6512-15                 |
| 19 cm – 7½" | ER 6512-19                 |



THOMS-ALLIS

6 : 7 Zähne  
6 : 7 teeth

|            |            |
|------------|------------|
| 20 cm – 8" | ER 6510-20 |
|------------|------------|



LITTLEWOOD



|               |                            |
|---------------|----------------------------|
|               | 2 : 3 Zähne<br>2 : 3 teeth |
| 18,5 cm – 7¼" | ER 6513-18                 |



LOCKWOOD



gefenstert  
fenestrated

|            |            |
|------------|------------|
| 20 cm – 8" | ER 6515-20 |
|------------|------------|





DE BAKEY Zahnung  
DE BAKEY Serration

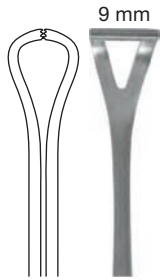

9 mm

|             |            |
|-------------|------------|
| 16 cm - 6¼" | ER 6517-16 |
| 20 cm - 8"  | ER 6517-20 |



BABCOCK-ATRAUMA

Standardmodell  
Standard pattern



9 mm

|             |            |
|-------------|------------|
| 16 cm - 6¼" | ER 6518-16 |
| 14 cm - 5½" | ER 6518-14 |
| 18 cm - 7"  | ER 6518-18 |
| 20 cm - 8"  | ER 6518-20 |
| 24 cm - 9½" | ER 6518-24 |



BABCOCK



25 cm - 10"

ER 6525-25

26 cm - 10¼"

ER 6525-26



DUVAL

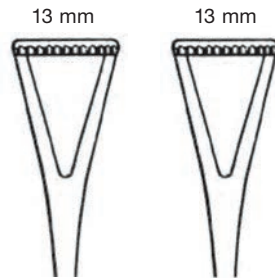

13 mm

13 mm

|            |            |
|------------|------------|
| 18 cm - 7" | 20 cm - 8" |
| ER 6520-18 | ER 6520-20 |



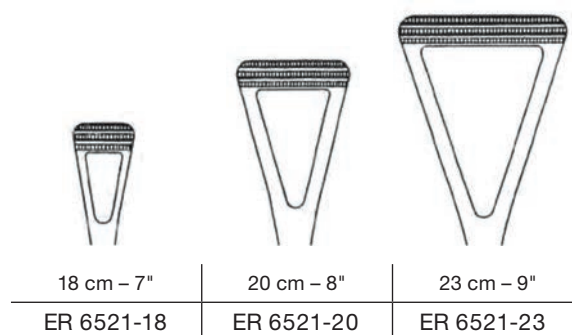

COLLIN

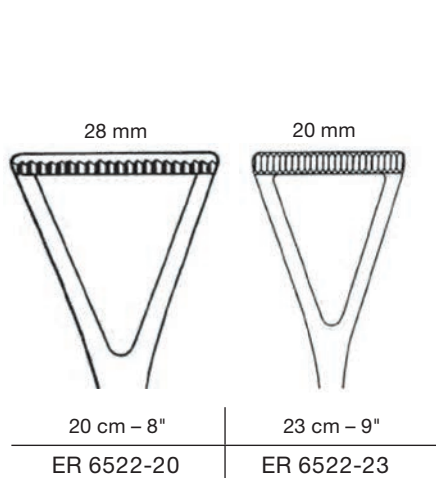

DUVAL

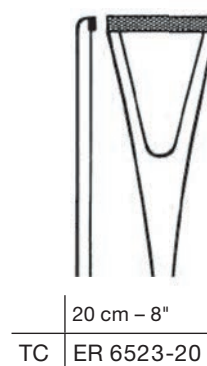

DUVAL

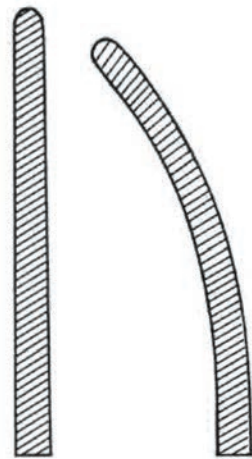

gerade  
straight

gebogen  
curved

18 cm - 7"

ER 6530-18

ER 6531-18



BABY-DOYEN

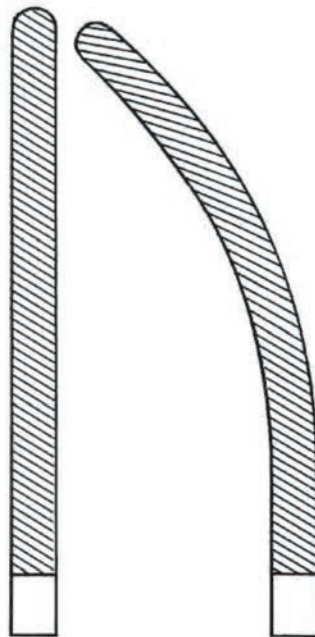

gerade  
straight

gebogen  
curved

21 cm - 8¼"

ER 6530-21

ER 6531-21

23 cm - 9"

ER 6530-23

ER 6531-23



DOYEN



DOYEN-ATRAUMA



DE BAKEY Zahnung  
DE BAKEY Serration

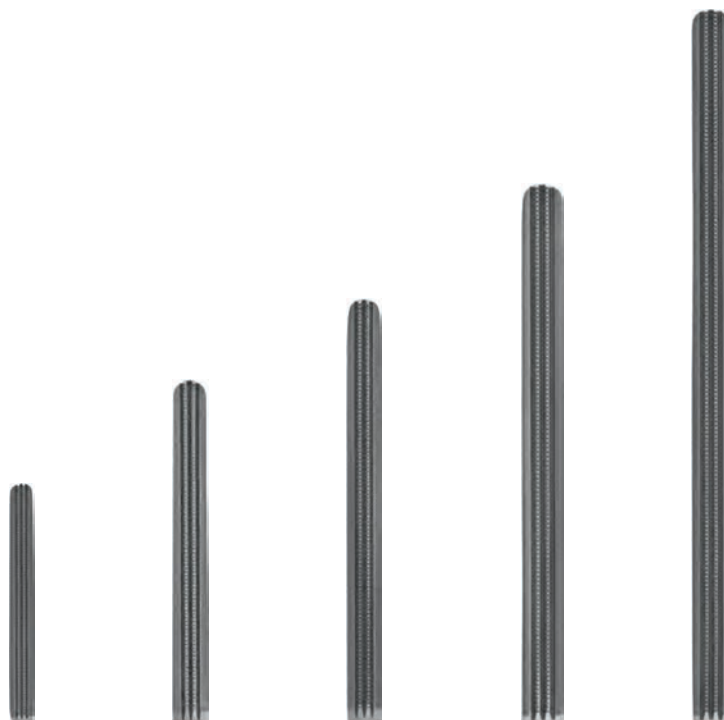

gerade  
straight

|            |             |            |             |            |
|------------|-------------|------------|-------------|------------|
| 13 cm – 5" | 16 cm – 6¼" | 18 cm – 7" | 21 cm – 8¼" | 23 cm – 9" |
| ER 6534-13 | ER 6534-16  | ER 6534-18 | ER 6534-21  | ER 6534-23 |



DOYEN-ATRAUMA



DE BAKEY Zahnung  
DE BAKEY Serration



gebogen  
curved

|            |             |            |             |            |
|------------|-------------|------------|-------------|------------|
| 13 cm – 5" | 16 cm – 6¼" | 18 cm – 7" | 21 cm – 8¼" | 23 cm – 9" |
| ER 6535-13 | ER 6535-16  | ER 6535-18 | ER 6535-21  | ER 6535-23 |

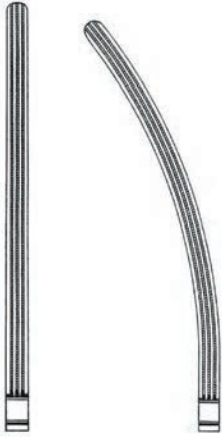

DE BAKEY Zahnung  
DE BAKEY Serration

gerade  
straight

gebogen  
curved

25 cm – 10"

ER 6542-25

ER 6543-25



MAYO-ROBSON ATRAUMA

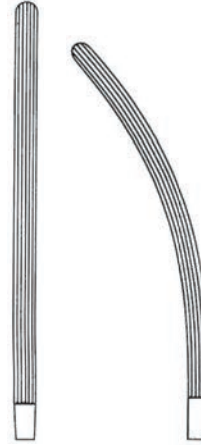

gerade  
straight

gebogen  
curved

25 cm – 10"

ER 6540-25

ER 6541-25



MAYO-ROBSON



gerade, sehr elastisch  
straight, very elastic blades

gebogen, sehr elastisch  
curved, very elastic blades

13 cm – 5"

ER 6550-13

ER 6551-13



BABY-KOCHER



KOCHER



gerade  
straight

gebogen  
curved

|             |             |             |             |             |             |
|-------------|-------------|-------------|-------------|-------------|-------------|
| 22 cm – 8¾" | 25 cm – 10" | 28 cm – 11" | 22 cm – 8¾" | 25 cm – 10" | 28 cm – 11" |
| ER 6550-22  | ER 6550-25  | ER 6550-28  | ER 6551-22  | ER 6551-25  | ER 6551-28  |



KOCHER-ATRAUMA



DE BAKEY Zahnung  
DE BAKEY Serration

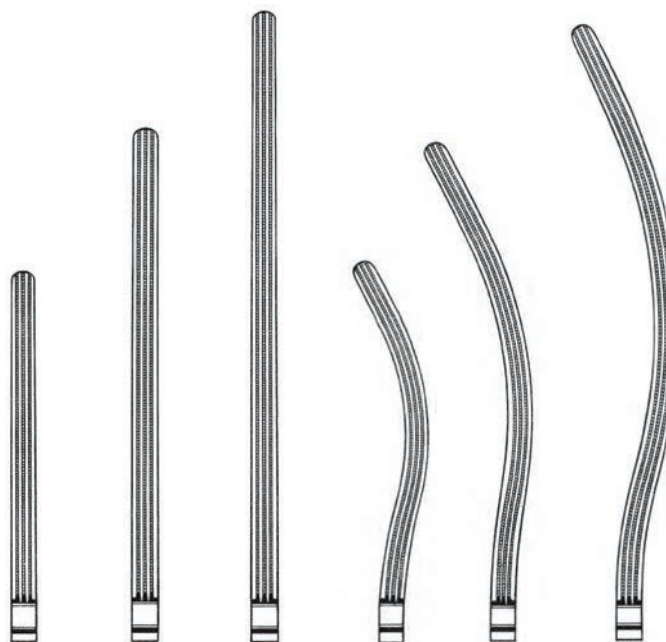

gerade  
straight

gebogen  
curved

|             |             |             |             |             |             |
|-------------|-------------|-------------|-------------|-------------|-------------|
| 22 cm – 8¾" | 25 cm – 10" | 28 cm – 11" | 22 cm – 8¾" | 25 cm – 10" | 28 cm – 11" |
| ER 6552-22  | ER 6552-25  | ER 6552-28  | ER 6553-22  | ER 6553-25  | ER 6553-28  |



Pylorusspreizer  
Pylorus spreader



gebogen, gerieft  
curved, serrated

15,5 cm - 6"

ER 6557-15



BENSON



gerade  
straight

15,5 cm - 6"

ER 6558-15

20 cm - 8"

ER 6558-20



1 : 2 Zähne  
1 : 2 teeth



ALLEN



gebogen  
curved

13 cm - 5"

ER 6559-12

Blinddarmklemme  
Appendectomy clamp



1 : 2 Zähne  
1 : 2 teeth



KLEINSCHMIDT





Magen- und Darm-Zwillingsklemmen  
Stomach and Intestinal Twin Clamps



PAYR

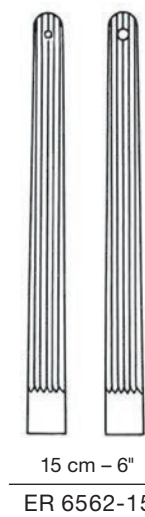
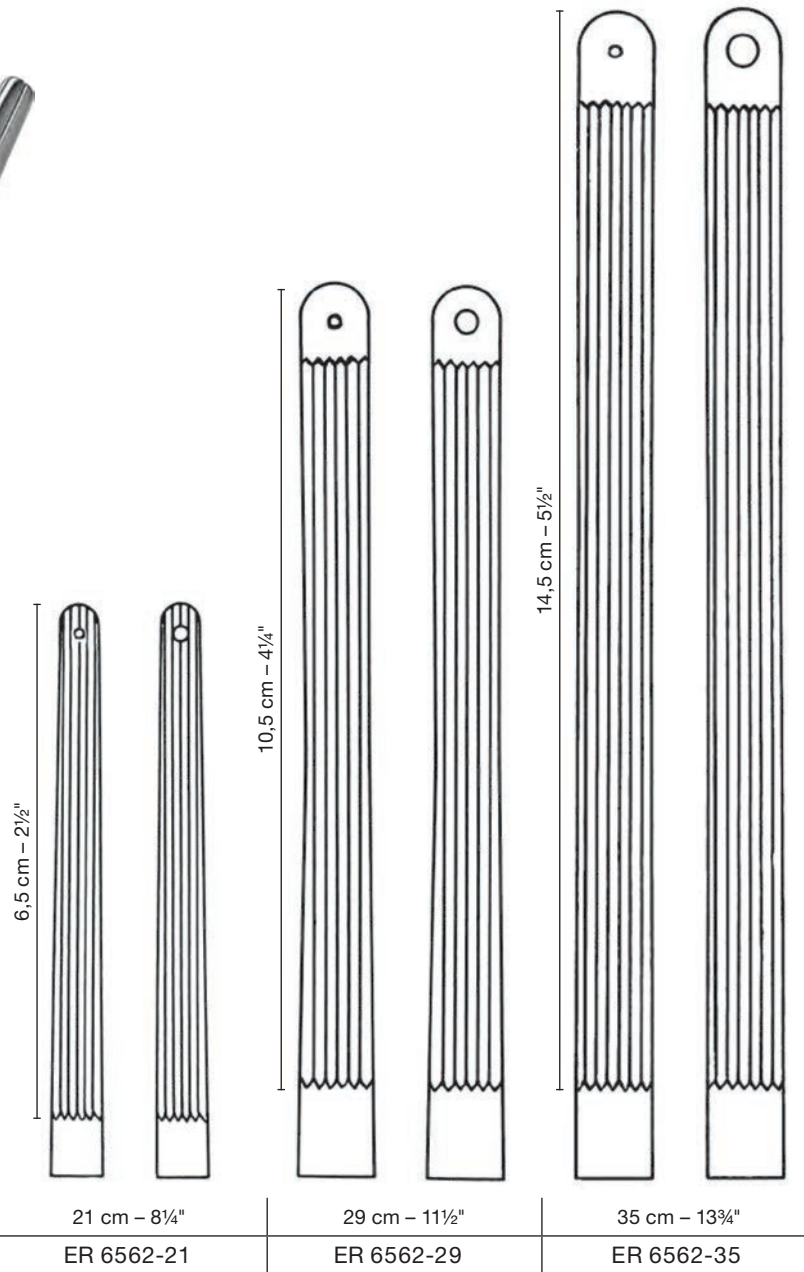





gerade  
straight

30 cm – 11¾"

ER 6570-30

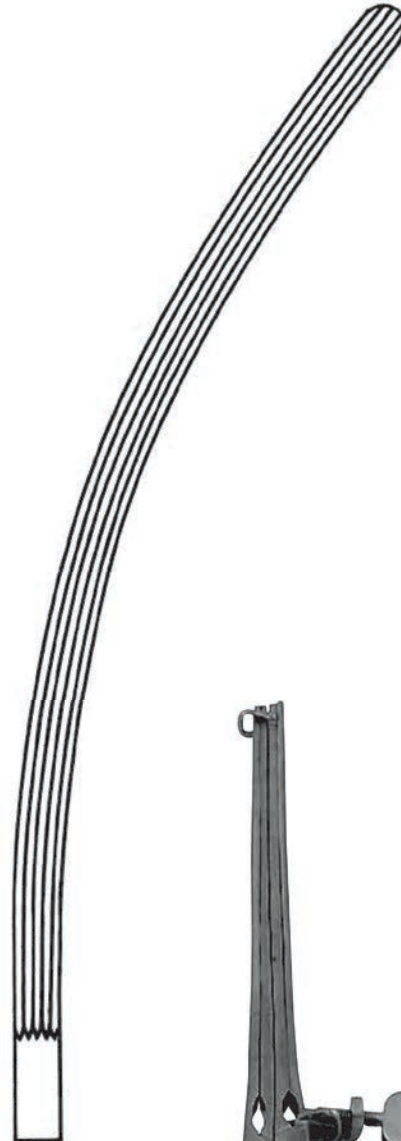

gebogen  
curved

30 cm – 11¾"

ER 6571-30



LANE



Rektum-Anastomosenklemmen  
Sigmoid Anastomosis Clamps

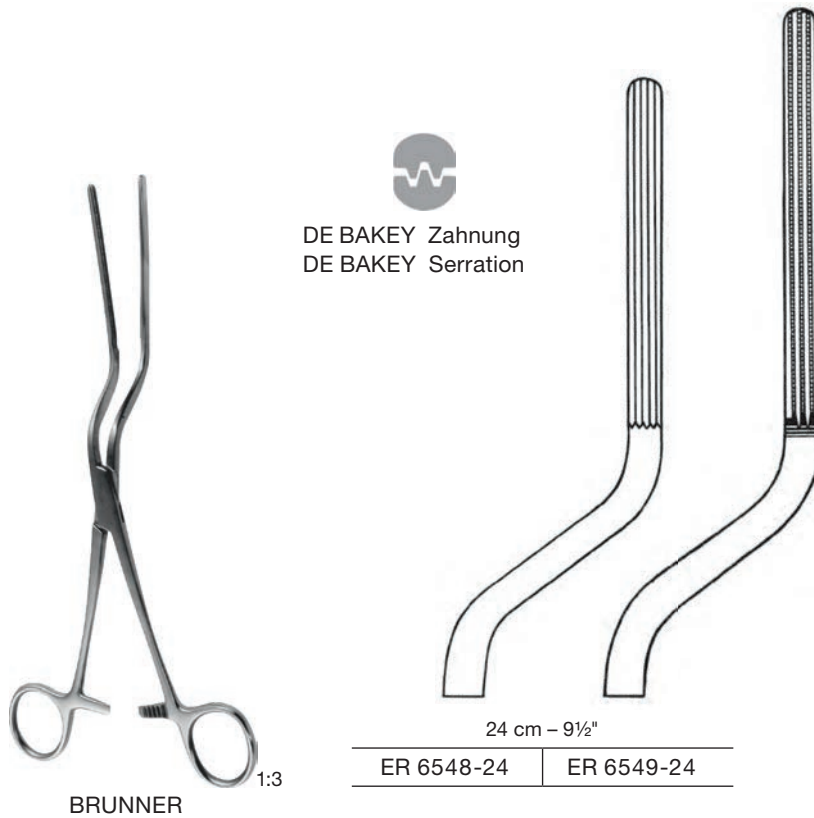





Rektum-Spekula  
Rectal Specula

20 mm



SIMS

| Gesamtlänge<br>Total length | Blattlänge<br>Length of blade |            |
|-----------------------------|-------------------------------|------------|
| 22 cm – 8¾"                 | 80 x 20 mm                    | ER 6595-08 |
|                             | 60 x 20 mm                    | ER 6595-06 |
|                             | 125 x 20 mm                   | ER 6595-12 |



MATHIEU

19,5 cm – 7¾"  
ER 6596-19



BARR

17 cm – 6¾"  
ER 6597-17



Anuskope  
Anuscopes

|        |                 |            |
|--------|-----------------|------------|
| Fig. 1 | Ø 16 mm x 65 mm | ER 6600-01 |
| Fig. 2 | Ø 19 mm x 65 mm | ER 6600-02 |
| Fig. 3 | Ø 22 mm x 70 mm | ER 6600-03 |

HIRSCHMANN

Anal spreizer  
Anal retractor

15 cm – 6"  
ER 6598-15



SMITH-BUIE

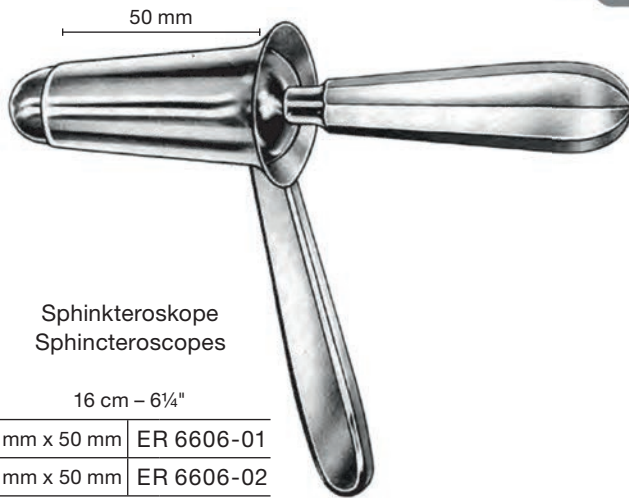

Sphinkterskope  
Sphincteroscopes

16 cm – 6¼"

|        |                 |            |
|--------|-----------------|------------|
| Fig. 1 | Ø 21 mm x 50 mm | ER 6606-01 |
| Fig. 2 | Ø 27 mm x 50 mm | ER 6606-02 |

KELLY



Anoskop  
Anuscope

14,5 cm – 5¾"  
ER 6604-00

IVES-FANSLER

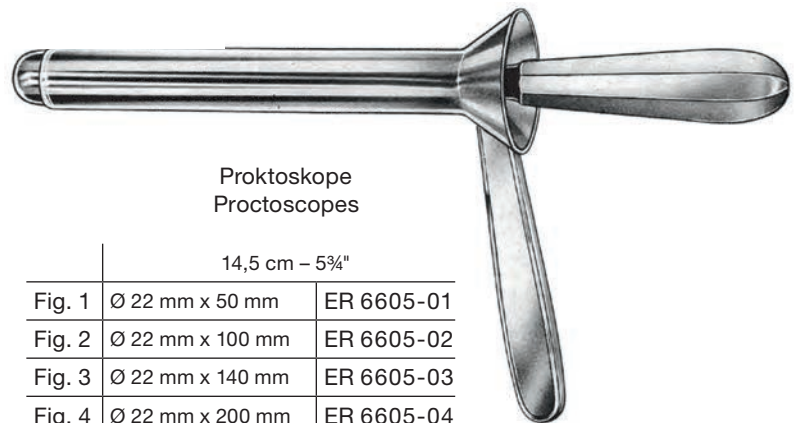

Proktoskope  
Proctoscopes

14,5 cm – 5¾"

|        |                  |            |
|--------|------------------|------------|
| Fig. 1 | Ø 22 mm x 50 mm  | ER 6605-01 |
| Fig. 2 | Ø 22 mm x 100 mm | ER 6605-02 |
| Fig. 3 | Ø 22 mm x 140 mm | ER 6605-03 |
| Fig. 4 | Ø 22 mm x 200 mm | ER 6605-04 |

KELLY





Analspreizer  
Rectal Spreader

Maßangaben für Mittelblätter  
und Blätter

- 1. Zahl = Länge
- 2. Zahl = Breite

Dimensions for central blades  
and blades

- 1st number = length
- 2nd number = width

Mittelblatt  
Beispiel: 95 x 22 mm  
Central blade  
Example: 95 x 22 mm



Blätter  
Beispiel: 60 x 25 mm  
Blades  
Example: 60 x 25 mm

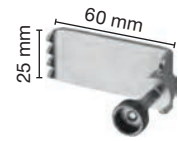

ALAN PARKS

|                                  |            |
|----------------------------------|------------|
| Sperrer allein<br>Retractor only | ER 6608-01 |
|----------------------------------|------------|

|   |            |
|---|------------|
| Satz komplett, bestehend aus:<br>Set complete, consisting of: | ER 6608-00 |
|---|------------|

- Sperrer allein, 14,5 cm – 5¾" (ER 6608-01)
- Retractor only, 14,5 cm – 5¾" (ER 6608-01)
- 1 Mittelblatt 95 x 22 mm (ER 6608-20)
- 1 Central blade 95 x 22 mm (ER 6608-20)
- 1 Paar Blätter seitlich, 70 x 20 mm (ER 6608-27)
- 1 pair of blades lateral, 70 x 20 mm (ER 6608-27)
- 1 Paar Blätter seitlich, 90 x 20 mm (ER 6608-29)
- 1 pair of blades lateral, 90 x 20 mm (ER 6608-29)



1 Paar  
1 pair

70 x 20 mm  
ER 6608-27



1 Paar  
1 pair

90 x 20 mm  
ER 6608-29



Mittelblatt  
Central blade

95 x 22 mm  
ER 6608-20



15 cm - 6"  
ER 3150-15



PRATT



gerade  
straight



gebogen  
curved

16 cm - 6 1/4"

ER 3390-16 | ER 3391-16



FERGUSSON



gerade  
straight

21 cm - 8 1/4"  
ER 6616-20

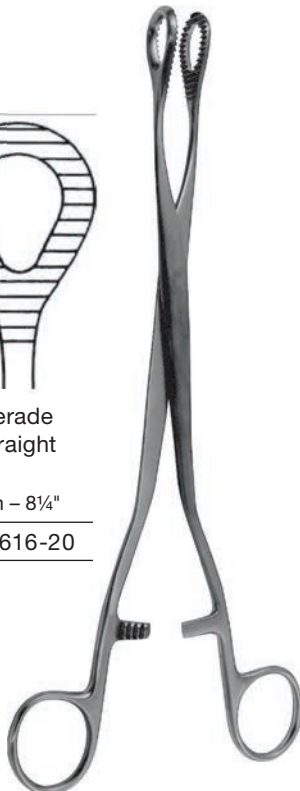

HEYWOOD-SMITH

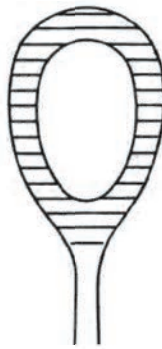

gerade  
straight

21 cm - 8 1/4"  
ER 6617-21



HEYWOOD-SMITH



MC GIVNEY



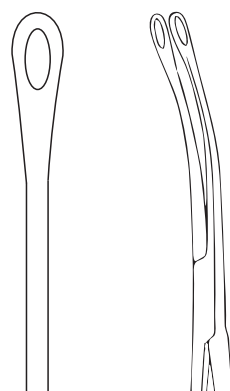

gerade  
straight

gebogen  
curved

20 cm - 8"

ER 6650-20

ER 6651-20



BLAKE

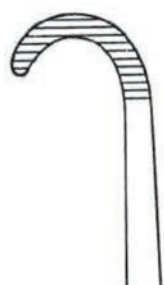

gebogen  
curved

21 cm - 8 1/4"

ER 6644-21



DESJARDINS



seitlich gebogen  
curved sideways

23 cm - 9"

Fig. 1

Fig. 2

ER 6657-23

ER 6658-23

Gallensteinzange  
Gall stone forceps



DESJARDINS

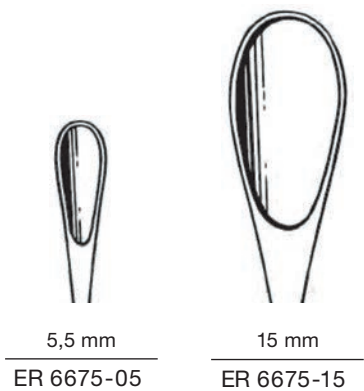
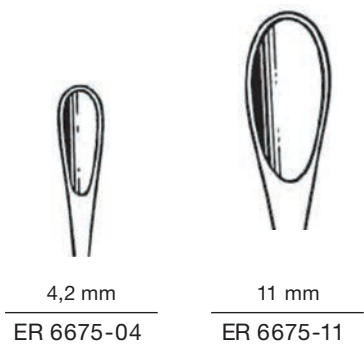
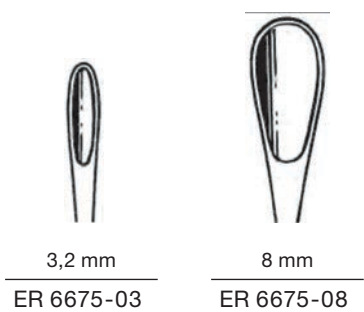
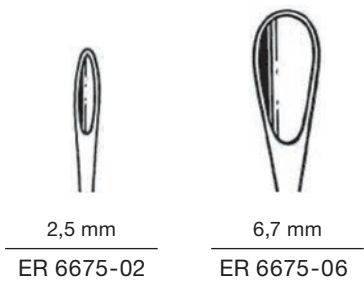

biegsam  
malleable

LUER-KOERTE  
32 cm – 12½"

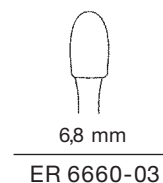
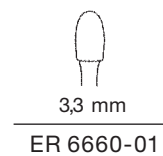

Gallengangsonden,  
federnd  
Gall duct probes,  
flexible



ER 6665-02  
ER 6665-03

DESJARDINS

Gallengangdilatoren,  
biegsam  
Bile duct dilators,  
malleable

| mm | 30 cm – 11¾" |
|----|--------------|
| 1  | ER 6665-01   |
| 2  | ER 6665-02   |
| 3  | ER 6665-03   |
| 4  | ER 6665-04   |
| 5  | ER 6665-05   |
| 6  | ER 6665-06   |
| 7  | ER 6665-07   |
| 8  | ER 6665-08   |
| 9  | ER 6665-09   |
| 10 | ER 6665-10   |
| 11 | ER 6665-11   |
| 12 | ER 6665-12   |
| 13 | ER 6665-13   |

Satz à 9 Stück  
ER 6665-03 – ER 6665-11  
in Leinentuchtasche  
Set of 9 pieces  
ER 6665-03 – ER 6665-11  
in canvas pocket  
ER 6665-50

BAKES

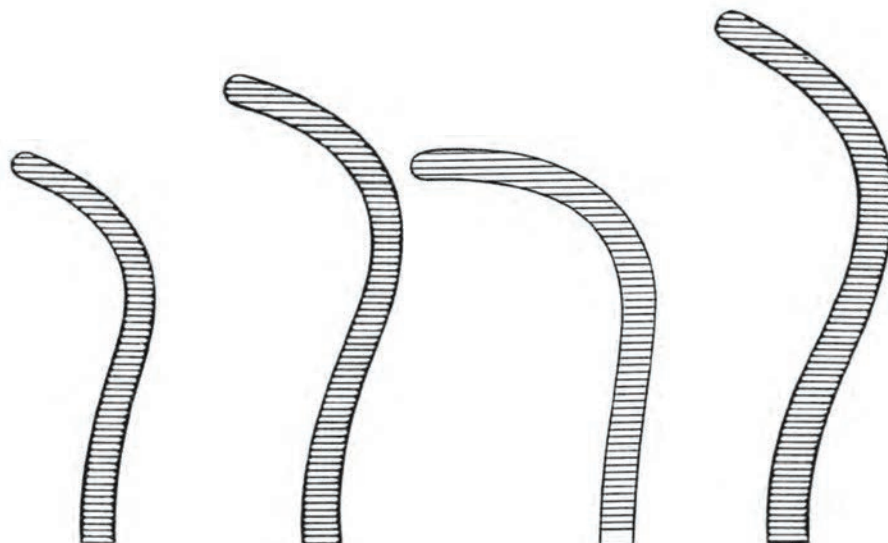

GUYON

|            |             |            |             |
|------------|-------------|------------|-------------|
| 20 cm – 8" | 22 cm – 8¾" | 23 cm – 9" | 24 cm – 9½" |
| ER 6630-20 | ER 6630-22  | ER 6632-23 | ER 6630-24  |



DE BAKEY Zahnung  
DE BAKEY Serration

HERRICK

23,5 cm – 9¼"  
ER 6635-23

GUYON / GUYON-ATRAUMA

GUYON-ATRAUMA  
23 cm – 9" | 24 cm – 9½"  
ER 6631-23 | ER 6631-24

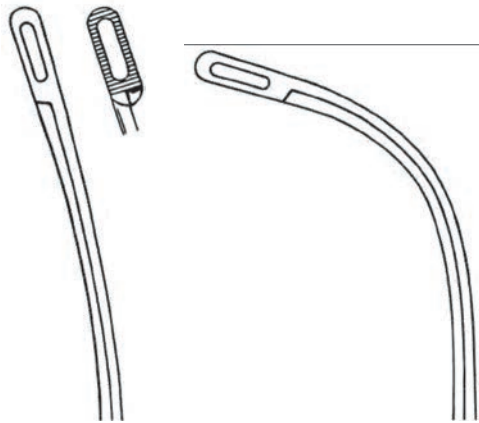

seitlich gebogen  
curved sideways

Fig. 1

24 cm – 9½"

ER 6640-01

Fig. 2

21 cm – 8¼"

ER 6640-02

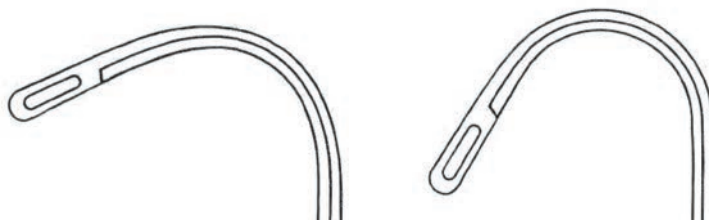

seitlich gebogen  
curved sideways

Fig. 3

20 cm – 8"

ER 6640-03

Fig. 4

20 cm – 8"

ER 6640-04



RANDALL

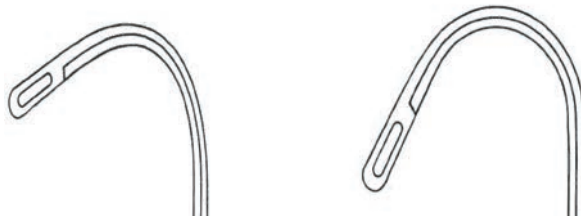

seitlich gebogen  
curved sideways

Fig. 3

19 cm – 7½"

ER 6640-05

Fig. 4

19 cm – 7½"

ER 6640-06



JUDD-MASSON

Satz komplett, bestehend aus:  
Set complete, consisting of:

ER 6706-00

Sperrer allein  
Retractor only

1 Paar Blätter seitlich, 67 x 25 mm, (max. Spreizweite 120mm)

1 pair of blades lateral, 67 x 25 mm, (max. spread 120mm)

1 Mittelblatt 75 x 25 mm

1 Central blade 75 x 25 mm





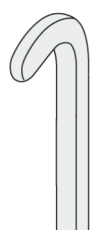

Blasenhalsspreizer  
Bladder neck spreader

29 cm – 11½"  
ER 6700-00

MILLIN

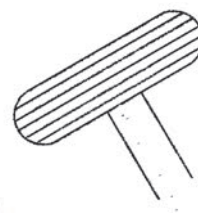

23 cm – 9"  
ER 6696-23

MILLIN



23 cm – 9"  
ER 6697-23

MILLIN

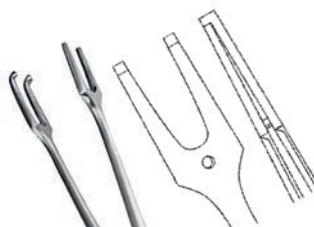

24 cm – 9½"  
ER 6698-23

MILLIN





Metalkatheter für Männer,  
gebogen  
Metal catheters for men,  
curved

| Fr. / Charr. | Ø mm | 29 cm – 11½" |
|--------------|------|--------------|
| 8            | 2⅔   | ER 6715-08   |
| 10           | 3⅓   | ER 6715-10   |
| 12           | 4    | ER 6715-12   |
| 14           | 4⅔   | ER 6715-14   |



Urethrale Bougies, gebogen  
Urethral bougies, curved

| Fr. / Charr. | Ø mm | 27 cm – 10½" |
|--------------|------|--------------|
| 8            | 2⅔   | ER 6710-08   |
| 10           | 3⅓   | ER 6710-10   |
| 12           | 4    | ER 6710-12   |
| 14           | 4⅔   | ER 6710-14   |
| 16           | 5⅓   | ER 6710-16   |
| 18           | 6    | ER 6710-18   |
| 20           | 6⅔   | ER 6710-20   |
| 22           | 7⅓   | ER 6710-22   |
| 24           | 8    | ER 6710-24   |
| 26           | 8⅔   | ER 6710-26   |
| 28           | 9⅓   | ER 6710-28   |
| 30           | 10   | ER 6710-30   |
| 32           | 10⅔  | ER 6710-32   |
| 34           | 10⅔  | ER 6710-34   |
| 36           | 12   | ER 6710-36   |



Katheter-Einführungsinstrument  
Catheter guide

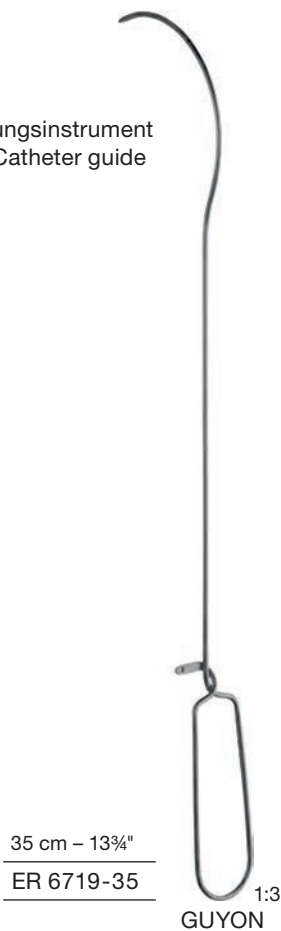

35 cm – 13¾"  
ER 6719-35

Metalkatheter für Frauen,  
gebogen  
Metal catheters for women,  
curved

| Fr. / Charr. | Ø mm | 16 cm – 6¼" |
|--------------|------|-------------|
| 8            | 3¼   | ER 6716-08  |
| 10           | 3⅓   | ER 6716-10  |
| 12           | 4    | ER 6716-12  |
| 14           | 4⅔   | ER 6716-14  |
| 16           | 5⅓   | ER 6716-16  |
| 18           | 6    | ER 6716-18  |



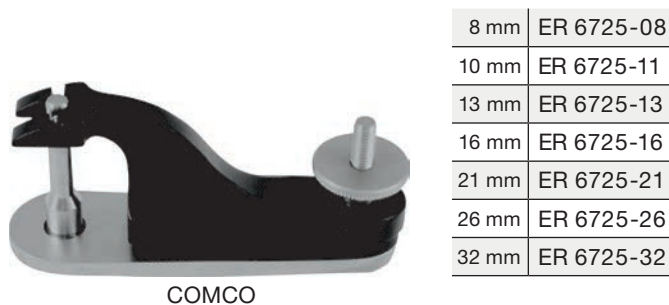
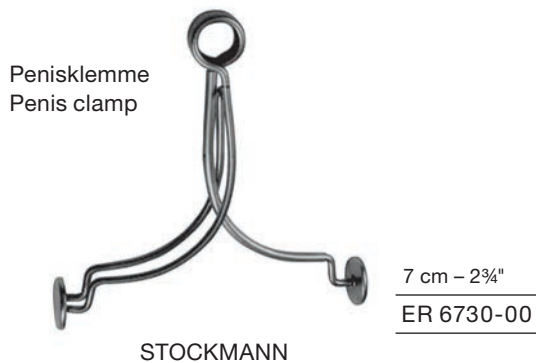
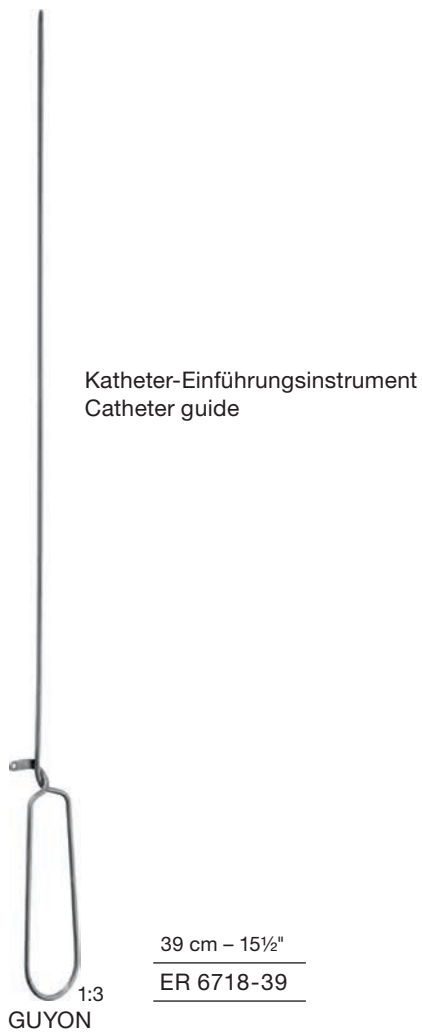



- Scheidenspekula** / *Vaginal Specula*
- Scheidenhalter** / *Vaginal Retractors*
- Uterusdilatatoren** / *Uterine Dilators*
- Endospekula für Cervix** / *Endospecula for Cervix*
- Uterussonden** / *Uterine Probes*
- Fasszangen** / *Grasping Forceps*
- Hakenzangen** / *Uterine Tenaculum Forceps*
- Polypen- und Ovarienzangen** / *Polypus- and Ovary Forceps*
- Uterusfasszangen** / *Uterine Elevating Forceps*
- Biopsie Instrumente** / *Biopsy Instruments*
- Parametriumklemmen** / *Parametrium Forceps*
- Hysterektomieklemmen** / *Hysterectomy Forceps*
- Vaginalklemmen** / *Vaginal Forceps*
- Biopsie Küretten** / *Biopsy Curettes*
- Biopsie Zangen** / *Biopsy Forceps*
- Uterus Biopsie Zangen** / *Uterine Biopsy Forceps*
- Uteruslöffel** / *Uterine Scoops*
- Uterusküretten** / *Uterine Curettes*
- Biopsie- und Absaugküretten** / *Biopsy and Aspirating Curettes*
- Salpingograph** / *Salpingograph*
- Geburtshilfe** / *Obstetrics*
- Geburtszangen** / *Obstetrical Forceps*
- Abortuszangen** / *Ovum Forceps*
- Plazentanzangen** / *Placenta Forceps*
- Uterusklemmzangen** / *Uterine Forceps*

## **Gynäkologie** *Gynecology*



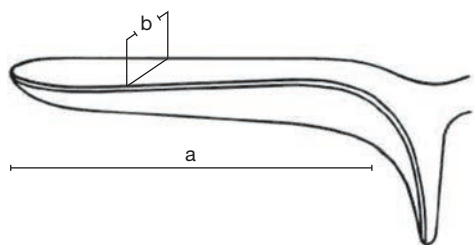

Maßschema für Spekulum  
Scheme of dimensions for specula

|   |                               |
|---|-------------------------------|
| a | Blattlänge<br>Length of blade |
| b | Blattbreite<br>Width of blade |



COLLIN

| a mm | b mm | für Jungfrauen<br>for virgins |
|------|------|-------------------------------|
| 90   | 32   | ER 7020-01                    |
| 115  | 35   | ER 7020-02                    |
| 115  | 40   | ER 7020-03                    |



CUSCO

| a mm | b mm |            |
|------|------|------------|
| 75   | 32   | ER 7000-01 |
| 85   | 36   | ER 7000-02 |
| 100  | 37   | ER 7000-03 |



CUSCO

| a mm | b mm | für Jungfrauen<br>for virgins |
|------|------|-------------------------------|
| 75   | 17   | ER 7002-00                    |



Maßschema für Spekulum  
Scheme of dimensions for specula

|   |                               |
|---|-------------------------------|
| a | Blattlänge<br>Length of blade |
| b | Blattbreite<br>Width of blade |

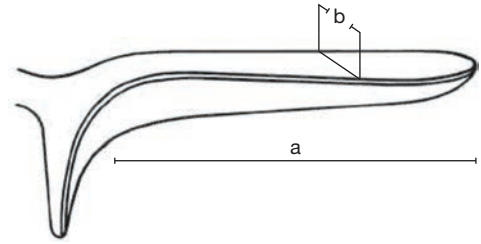

lang und schmal  
long and narrow

CUSCO

| a mm | b mm  | Schweizer Modell<br>Swiss pattern |
|------|-------|-----------------------------------|
| 90   | 23-25 | ER 7004-01                        |
| 100  | 25-27 | ER 7004-02                        |
| 110  | 27-30 | ER 7004-03                        |

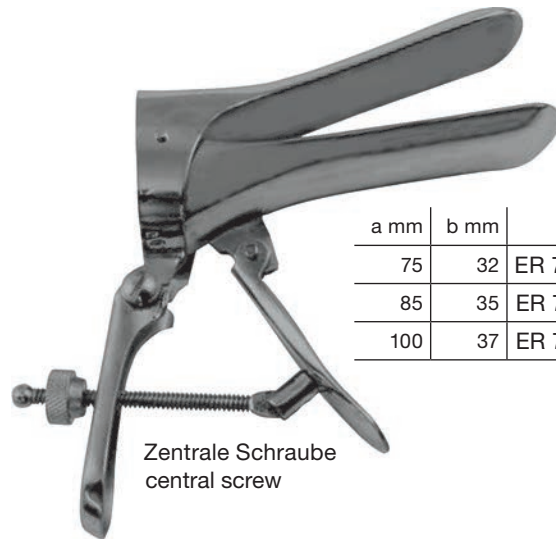

Zentrale Schraube  
central screw

CUSCO

| a mm | b mm |            |
|------|------|------------|
| 75   | 32   | ER 7001-01 |
| 85   | 35   | ER 7001-02 |
| 100  | 37   | ER 7001-03 |



TRÉLAT

| a mm | b mm |            |
|------|------|------------|
| 85   | 33   | ER 7022-01 |
| 95   | 35   | ER 7022-02 |
| 115  | 43   | ER 7022-03 |

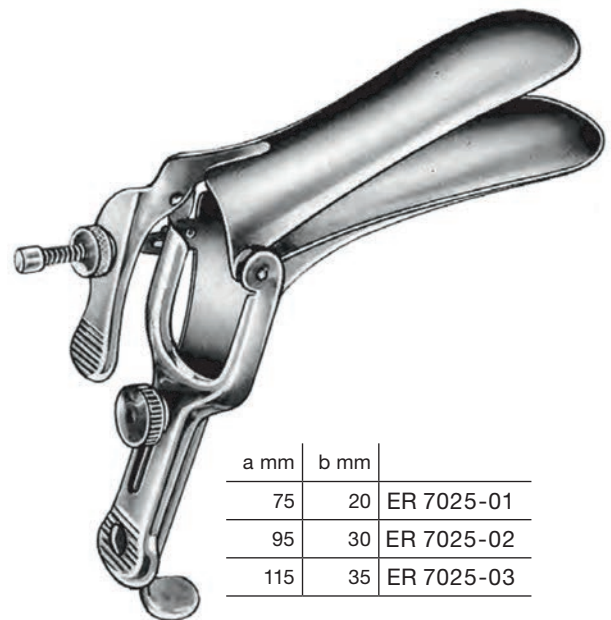

GRAVE

| a mm | b mm |            |
|------|------|------------|
| 75   | 20   | ER 7025-01 |
| 95   | 30   | ER 7025-02 |
| 115  | 35   | ER 7025-03 |



## Scheidenspekula Vaginal Specula

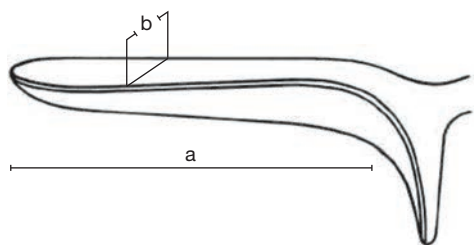

Maßschema für Spekulum  
Scheme of dimensions for specula

|   |                               |
|---|-------------------------------|
| a | Blattlänge<br>Length of blade |
| b | Blattbreite<br>Width of blade |

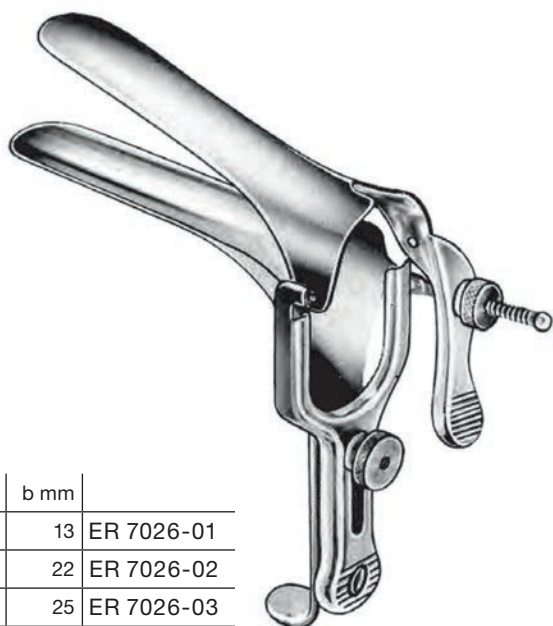

| a mm | b mm |            |
|------|------|------------|
| 75   | 13   | ER 7026-01 |
| 100  | 22   | ER 7026-02 |
| 120  | 25   | ER 7026-03 |

PEDERSON



| L mm | a mm | b mm |            |
|------|------|------|------------|
| 90   | 14   | 18   | ER 7028-00 |
| 100  | 17   | 20   | ER 7028-01 |
| 100  | 25   | 30   | ER 7028-02 |

SEMM





Maßschema für Spekulum  
Scheme of dimensions for specula

|   |                               |
|---|-------------------------------|
| a | Blattlänge<br>Length of blade |
| b | Blattbreite<br>Width of blade |

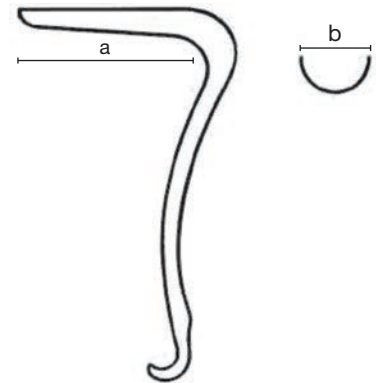

| L mm | A mm | B mm |            |
|------|------|------|------------|
| 125  | 70   | 26   | ER 7050-01 |
|      | 75   | 30   |            |
| 150  | 75   | 30   | ER 7050-02 |
|      | 80   | 35   |            |
| 175  | 80   | 36   | ER 7050-03 |
|      | 90   | 40   |            |

Satz  
Set

ER 7050-00

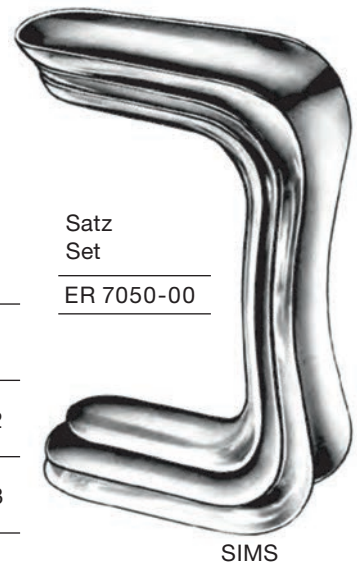

SIMS

|   |            |
|---|------------|
| Scheidenspekulum komplett, bestehend aus:<br>Vaginal specula complete, consisting of: | ER 7078-01 |
|---|------------|

- 1 Spekulum Fig. 1, 70 x 40 mm (ER 7078-11)
- 1 Specula ig. 1, 70 x 40 mm (ER 7078-11)
- 1 Halter Fig. 1, 70 x 33 mm (ER 7078-21)
- 1 Retractor ig. 1, 70 x 33 mm (ER 7078-21)

|   |            |
|---|------------|
| Scheidenspekulum komplett, bestehend aus:<br>Vaginal specula complete, consisting of: | ER 7078-02 |
|---|------------|

- 1 Spekulum Fig. 2, 90 x 40 mm (ER 7078-12)
- 1 Specula ig. 2, 90 x 40 mm (ER 7078-12)
- 1 Halter Fig. 2, 90 x 33 mm (ER 7078-22)
- 1 Retractor ig. 2, 90 x 33 mm (ER 7078-22)

| Fig. | a mm | b mm | Spekulum<br>Specula |
|------|------|------|---------------------|
| 1    | 70   | 40   | ER 7078-11          |
| 2    | 90   | 40   | ER 7078-12          |

| Fig. | a mm | b mm | Halter<br>Retractor |
|------|------|------|---------------------|
| 1    | 70   | 33   | ER 7078-21          |
| 2    | 90   | 33   | ER 7078-22          |



KALLMORGEN



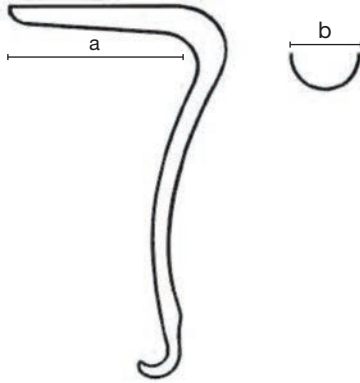

Maßschema für Spekulum  
Scheme of dimensions for specula

|   |                               |
|---|-------------------------------|
| a | Blattlänge<br>Length of blade |
| b | Blattbreite<br>Width of blade |

| Fig. | a mm | b mm |            |
|------|------|------|------------|
| 1    | 75   | 40   | ER 7056-01 |
| 2    | 90   | 40   | ER 7056-02 |
| 3    | 100  | 40   | ER 7056-03 |



|   |            |
|---|------------|
| Scheidenspekulum für Kinder komplett, bestehend aus:<br>Vaginal specula for children complete, consisting of: | ER 7060-00 |
|---|------------|

- 1 Spekulum, 70 x 15 mm (ER 7060-30)
- 1 Specula, 70 x 15 mm (ER 7060-30)
- 1 Halter, 75 x 10 mm (ER 7060-40)
- 1 Retractor, 75 x 10 mm (ER 7060-40)

| a mm | b mm | Spekulum<br>Specula |
|------|------|---------------------|
| 70   | 15   | ER 7060-30          |

| a mm | b mm | Halter<br>Retractor |
|------|------|---------------------|
| 75   | 10   | ER 7060-40          |



Maßschema für Spekulum  
Scheme of dimensions for specula

|   |                               |
|---|-------------------------------|
| a | Blattlänge<br>Length of blade |
| b | Blattbreite<br>Width of blade |

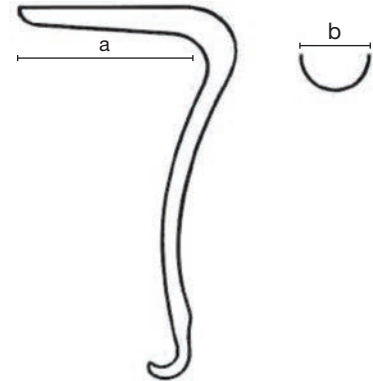

|  |            |
|--|------------|
| Scheidenspekulum komplett, bestehend aus:<br>Vaginal specula complete, consisting of:  | ER 7060-01 |
| 1 Spekulum Fig. 1, 70 x 27 mm (ER 7060-11)<br>1 Specula ig. 1, 70 x 27 mm (ER 7060-11)<br>1 Halter Fig. 1, 75 x 23 mm (ER 7060-21)<br>1 Retractor ig. 1, 75 x 23 mm (ER 7060-21) |            |
| Scheidenspekulum komplett, bestehend aus:<br>Vaginal specula complete, consisting of:  | ER 7060-02 |
| 1 Spekulum Fig. 2, 75 x 30 mm (ER 7060-12)<br>1 Specula ig. 2, 75 x 30 mm (ER 7060-12)<br>1 Halter Fig. 2, 80 x 26 mm (ER 7060-22)<br>1 Retractor ig. 2, 80 x 26 mm (ER 7060-22) |            |
| Scheidenspekulum komplett, bestehend aus:<br>Vaginal specula complete, consisting of:  | ER 7060-03 |
| 1 Spekulum Fig. 3, 90 x 36 mm (ER 7060-13)<br>1 Specula ig. 3, 90 x 36 mm (ER 7060-13)<br>1 Halter Fig. 3, 95 x 32 mm (ER 7060-23)<br>1 Retractor ig. 3, 95 x 32 mm (ER 7060-23) |            |

| Fig. | a mm | b mm | Spekulum<br>Specula | Fig. | a mm | b mm | Halter<br>Retractor |
|------|------|------|---------------------|------|------|------|---------------------|
| 1    | 70   | 27   | ER 7060-11          | 1    | 75   | 23   | ER 7060-21          |
| 2    | 75   | 30   | ER 7060-12          | 2    | 80   | 26   | ER 7060-22          |
| 3    | 90   | 36   | ER 7060-13          | 3    | 95   | 32   | ER 7060-23          |



KRISTELLER

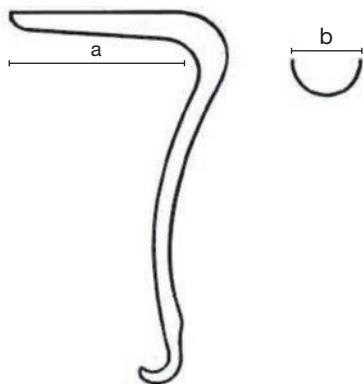

Maßschema für Spekulum  
Scheme of dimensions for specula

|   |                               |
|---|-------------------------------|
| a | Blattlänge<br>Length of blade |
| b | Blattbreite<br>Width of blade |



mit konisch verlaufenden  
Blättern, für Jungfrauen  
with conically shaped  
blades, for virgins

KRISTELLER

|  |            |
|--|------------|
| Scheidenspekulum komplett, bestehend aus:<br>Vaginal specula complete, consisting of:  | ER 7065-01 |
| 1 Spekulum Fig. 00, 105 x 18 mm (ER 7065-11)<br>1 Specula ig. 00, 105 x 18 mm (ER 7065-11)<br>1 Halter Fig. 00, 110 x 14 mm (ER 7065-21)<br>1 Retractor ig. 00, 110 x 14 mm (ER 7065-21) |            |

|  |            |
|--|------------|
| Scheidenspekulum komplett, bestehend aus:<br>Vaginal specula complete, consisting of:  | ER 7065-02 |
| 1 Spekulum Fig. 0, 105 x 21 mm (ER 7065-12)<br>1 Specula ig. 0, 105 x 21 mm (ER 7065-12)<br>1 Halter Fig. 0, 110 x 17 mm (ER 7065-22)<br>1 Retractor ig. 0, 110 x 17 mm (ER 7065-22) |            |

| Fig. | a mm | b mm | Spekulum<br>Specula | Fig. | a mm | b mm | Halter<br>Retractor |
|------|------|------|---------------------|------|------|------|---------------------|
| 00   | 105  | 18   | ER 7065-11          | 00   | 110  | 14   | ER 7065-21          |
| 0    | 105  | 21   | ER 7065-12          | 0    | 110  | 17   | ER 7065-22          |



Maßschema für Spekulum  
Scheme of dimensions for specula

|   |                               |
|---|-------------------------------|
| a | Blattlänge<br>Length of blade |
| b | Blattbreite<br>Width of blade |

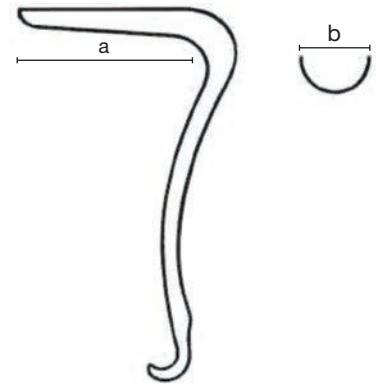

|  |            |
|--|------------|
| Scheidenspekulum komplett, bestehend aus:<br>Vaginal specula complete, consisting of:  | ER 7070-01 |
| 1 Spekulum Fig. 1, 110 x 27 mm (ER 7070-11)<br>1 Specula ig. 1, 110 x 27 mm (ER 7070-11)<br>1 Halter Fig. 1, 115 x 23 mm (ER 7070-21)<br>1 Retractor ig. 1, 115 x 23 mm (ER 7070-21) |            |
| Scheidenspekulum komplett, bestehend aus:<br>Vaginal specula complete, consisting of:  | ER 7070-02 |
| 1 Spekulum Fig. 2, 110 x 30 mm (ER 7070-12)<br>1 Specula ig. 2, 110 x 30 mm (ER 7070-12)<br>1 Halter Fig. 2, 115 x 26 mm (ER 7070-22)<br>1 Retractor ig. 2, 115 x 26 mm (ER 7070-22) |            |
| Scheidenspekulum komplett, bestehend aus:<br>Vaginal specula complete, consisting of:  | ER 7070-03 |
| 1 Spekulum Fig. 3, 110 x 36 mm (ER 7070-13)<br>1 Specula ig. 3, 110 x 36 mm (ER 7070-13)<br>1 Halter Fig. 3, 115 x 32 mm (ER 7070-23)<br>1 Retractor ig. 3, 115 x 32 mm (ER 7070-23) |            |

| Fig. | a mm | b mm | Spekulum<br>Specula | Fig. | a mm | b mm | Halter<br>Retractor |
|------|------|------|---------------------|------|------|------|---------------------|
| 1    | 110  | 27   | ER 7070-11          | 1    | 115  | 23   | ER 7070-21          |
| 2    | 110  | 30   | ER 7070-12          | 2    | 115  | 26   | ER 7070-22          |
| 3    | 110  | 36   | ER 7070-13          | 3    | 115  | 32   | ER 7070-23          |



mit tiefem Spekula  
with deep hollow specula

KRISTELLER

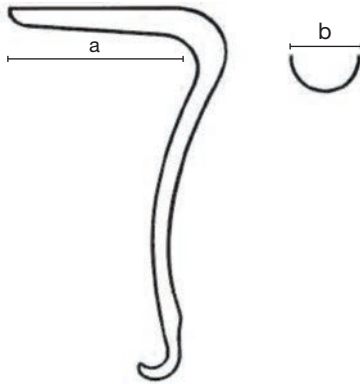

Maßschema für Spekulum  
Scheme of dimensions for specula

|   |                               |
|---|-------------------------------|
| a | Blattlänge<br>Length of blade |
| b | Blattbreite<br>Width of blade |



mit lachen Spekulum  
with lat hollow specula

KRISTELLER

|   |            |
|---|------------|
| Scheidenspekulum komplett, bestehend aus:<br>Vaginal specula complete, consisting of: | ER 7072-01 |
|---|------------|

- 1 Spekulum Fig. 1, 110 x 27 mm (ER 7072-11)
- 1 Specula ig. 1, 110 x 27 mm (ER 7072-11)
- 1 Halter Fig. 1, 115 x 23 mm (ER 7072-21)
- 1 Retractor ig. 1, 115 x 23 mm (ER 7072-21)

|   |            |
|---|------------|
| Scheidenspekulum komplett, bestehend aus:<br>Vaginal specula complete, consisting of: | ER 7072-02 |
|---|------------|

- 1 Spekulum Fig. 2, 110 x 30 mm (ER 7072-12)
- 1 Specula ig. 2, 110 x 30 mm (ER 7072-12)
- 1 Halter Fig. 2, 115 x 26 mm (ER 7072-22)
- 1 Retractor ig. 2, 115 x 26 mm (ER 7072-22)

|   |            |
|---|------------|
| Scheidenspekulum komplett, bestehend aus:<br>Vaginal specula complete, consisting of: | ER 7072-03 |
|---|------------|

- 1 Spekulum Fig. 3, 110 x 36 mm (ER 7072-13)
- 1 Specula ig. 3, 110 x 36 mm (ER 7072-13)
- 1 Halter Fig. 3, 115 x 32 mm (ER 7072-23)
- 1 Retractor ig. 3, 115 x 32 mm (ER 7072-23)

| Fig. | a mm | b mm | Spekulum<br>Specula | Fig. | a mm | b mm | Halter<br>Retractor |
|------|------|------|---------------------|------|------|------|---------------------|
| 1    | 105  | 26   | ER 7072-11          | 1    | 115  | 22   | ER 7072-21          |
| 2    | 105  | 28   | ER 7072-12          | 2    | 115  | 24   | ER 7072-22          |
| 3    | 105  | 33   | ER 7072-13          | 3    | 115  | 39   | ER 7072-23          |



Maßschema für Spekulum  
Scheme of dimensions for specula

|   |                               |
|---|-------------------------------|
| a | Blattlänge<br>Length of blade |
| b | Blattbreite<br>Width of blade |

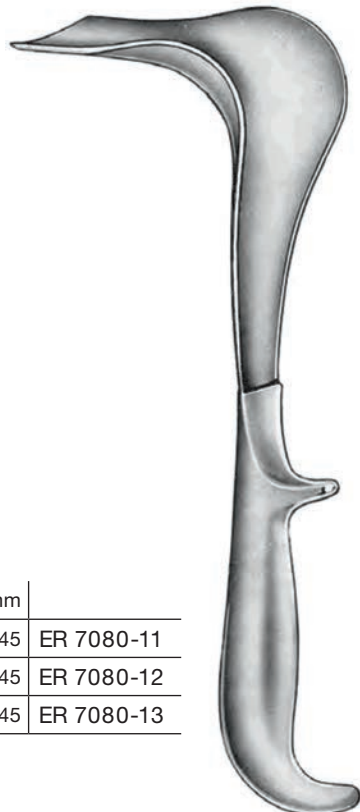
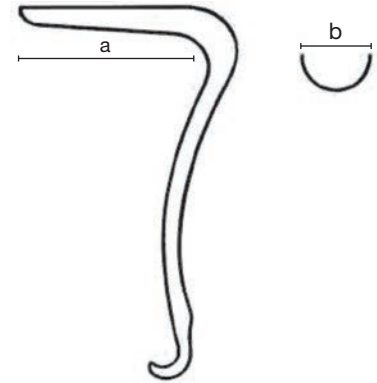

DOYEN

| Fig. | a mm | b mm |            |
|------|------|------|------------|
| 1    | 75   | 45   | ER 7080-11 |
| 2    | 90   | 45   | ER 7080-12 |
| 3    | 110  | 45   | ER 7080-13 |

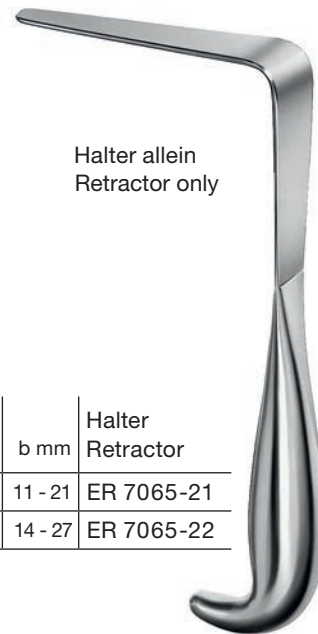

Halter allein  
Retractor only

| a mm | b mm    | Halter<br>Retractor |
|------|---------|---------------------|
| 100  | 11 - 21 | ER 7065-21          |
| 100  | 14 - 27 | ER 7065-22          |

MATHIEU



Spekulum allein  
Speculum only

| a mm | b mm    | Spekulum<br>Specula |
|------|---------|---------------------|
| 95   | 16 - 26 | ER 70 79-11         |
| 95   | 16 - 30 | ER 70 79-12         |

MATHIEU

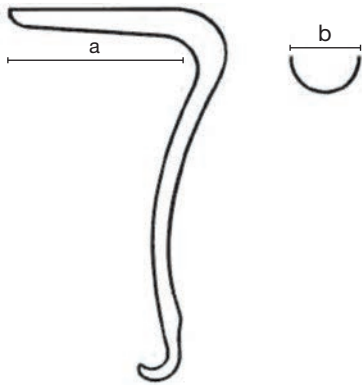

Maßschema für Spekulum  
Scheme of dimensions for specula

|   |                               |
|---|-------------------------------|
| a | Blattlänge<br>Length of blade |
| b | Blattbreite<br>Width of blade |

24 cm – 9½"

| Fig. | a mm | b mm | leicht hohl<br>slightly-concave |
|------|------|------|---------------------------------|
| 1    | 60   | 35   | ER 7080-01                      |
| 2    | 90   | 35   | ER 7080-02                      |
| 3    | 120  | 35   | ER 7080-03                      |
| 1    | 60   | 45   | ER 7081-01                      |
| 2    | 90   | 45   | ER 7081-02                      |
| 3    | 120  | 45   | ER 7081-03                      |
| 4    | 160  | 45   | ER 7081-04                      |
| 1    | 60   | 60   | ER 7082-01                      |
| 2    | 90   | 60   | ER 7082-02                      |
| 3    | 120  | 60   | ER 7082-03                      |
| 4    | 160  | 60   | ER 7082-04                      |



DOYEN



BREISKY

| a mm | b mm |            |
|------|------|------------|
| 100  | 20   | ER 7090-20 |
| 100  | 25   | ER 7090-25 |
| 100  | 30   | ER 7090-30 |
| 100  | 35   | ER 7090-35 |
| 100  | 40   | ER 7090-40 |
| 130  | 20   | ER 7091-20 |
| 130  | 25   | ER 7091-25 |
| 130  | 30   | ER 7091-30 |
| 130  | 35   | ER 7091-35 |
| 130  | 40   | ER 7091-40 |





Maßschema für Spekulum  
Scheme of dimensions for specula

|   |                               |
|---|-------------------------------|
| a | Blattlänge<br>Length of blade |
| b | Blattbreite<br>Width of blade |

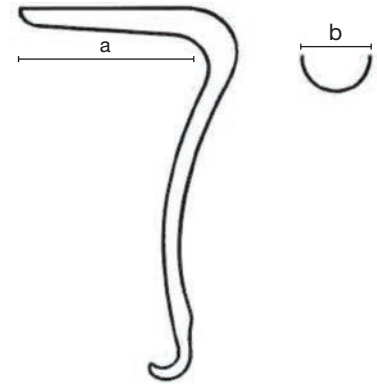

| a mm | b mm | 25 cm – 10" |
|------|------|-------------|
| 60   | 30   | ER 7086-01  |
| 70   | 30   | ER 7086-02  |
| 80   | 30   | ER 7086-25  |

|             | 25 cm – 10" |
|-------------|-------------|
| 60 x 20 mm  | ER 4542-01  |
| 80 x 30 mm  | ER 4542-02  |
| 100 x 30 mm | ER 4542-03  |
| 120 x 30 mm | ER 4542-04  |
| 140 x 30 mm | ER 4542-05  |
| 140 x 40 mm | ER 4542-06  |

DOYEN

HÖSEL

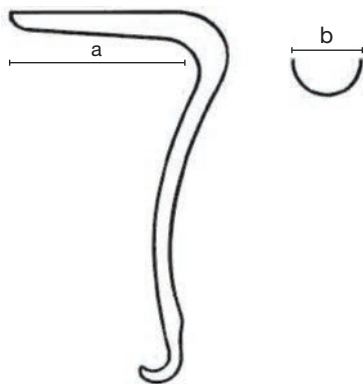

Maßschema für Spekulum  
Scheme of dimensions for specula

|   |                               |
|---|-------------------------------|
| a | Blattlänge<br>Length of blade |
| b | Blattbreite<br>Width of blade |



mit abnehmbarem Gewicht  
with detachable weight

|      |      |            |
|------|------|------------|
| a mm | b mm |            |
| 80   | 38   | ER 7088-00 |

AUVARD



mit festem Gewicht  
with fixed weight

|      |      |            |
|------|------|------------|
| a mm | b mm |            |
| 70   | 38   | ER 7088-51 |

AUVARD



| Ø mm | 18,5 cm – 7½" |
|------|---------------|
| 1    | ER 7100-01    |
| 2    | ER 7100-02    |
| 3    | ER 7100-03    |
| 4    | ER 7100-04    |
| 5    | ER 7100-05    |
| 6    | ER 7100-06    |
| 7    | ER 7100-07    |
| 8    | ER 7100-08    |
| 9    | ER 7100-09    |
| 10   | ER 7100-10    |
| 11   | ER 7100-11    |
| 12   | ER 7100-12    |
| 13   | ER 7100-13    |
| 14   | ER 7100-14    |
| 15   | ER 7100-15    |

| Ø mm | 18,5 cm – 7½" |
|------|---------------|
| 16   | ER 7100-16    |
| 17   | ER 7100-17    |
| 18   | ER 7100-18    |
| 19   | ER 7100-19    |
| 20   | ER 7100-20    |
| 21   | ER 7100-21    |
| 22   | ER 7100-22    |
| 23   | ER 7100-23    |
| 24   | ER 7100-24    |
| 25   | ER 7100-25    |
| 26   | ER 7100-26    |

| Ø mm | 18,5 cm – 7½" |
|------|---------------|
| 1,5  | ER 7101-01    |
| 2,5  | ER 7101-02    |
| 3,5  | ER 7101-03    |
| 4,5  | ER 7101-04    |
| 5,5  | ER 7101-05    |
| 6,5  | ER 7101-06    |
| 7,5  | ER 7101-07    |
| 8,5  | ER 7101-08    |
| 9,5  | ER 7101-09    |
| 10,5 | ER 7101-10    |
| 11,5 | ER 7101-11    |
| 12,5 | ER 7101-12    |
| 13,5 | ER 7101-13    |
| 14,5 | ER 7101-14    |
| 15,5 | ER 7101-15    |
| 16,5 | ER 7101-16    |
| 17,5 | ER 7101-17    |



HEGAR

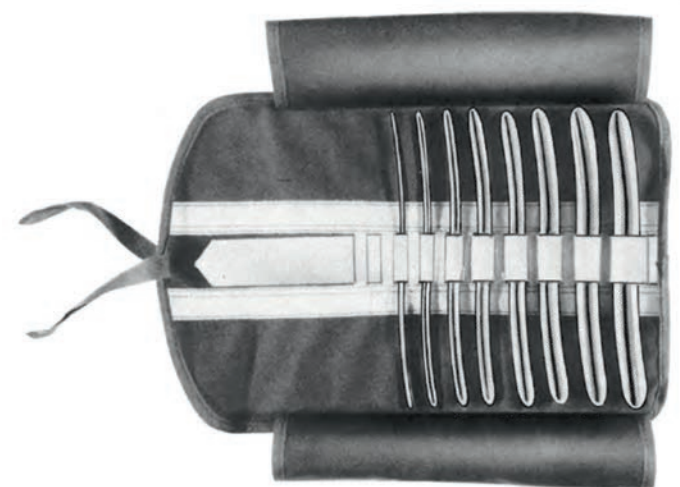

| Stück per Satz<br>Pieces per set  | Satz<br>Set |
|-----------------------------------|-------------|
| 8 St. / pcs. (3 / 4 – 17 / 18 mm) | ER 7102-30  |

| Ø mm    | 20 cm – 8" |
|---------|------------|
| 1 / 2   | ER 7102-02 |
| 3 / 4   | ER 7102-04 |
| 5 / 6   | ER 7102-06 |
| 7 / 8   | ER 7102-08 |
| 9 / 10  | ER 7102-10 |
| 11 / 12 | ER 7102-12 |
| 13 / 14 | ER 7102-14 |
| 15 / 16 | ER 7102-16 |
| 17 / 18 | ER 7102-18 |
| 19 / 20 | ER 7102-20 |
| 21 / 22 | ER 7102-22 |
| 23 / 24 | ER 7102-24 |
| 25 / 26 | ER 7102-26 |



HEGAR



## Uterussonden Uterine Probes

4 mm

mit cm-Graduierung  
with cm graduation

1:3

MARTIN (SIMPSON)

32 cm – 12½"

|                |            |
|----------------|------------|
| starr<br>rigid | ER 7133-32 |
|----------------|------------|

|                      |            |
|----------------------|------------|
| biegsam<br>malleable | ER 7134-32 |
|----------------------|------------|

SIMS

4 mm

mit cm-Graduierung  
with cm graduation

1:3

SIMS

32 cm – 12½"

|                |            |
|----------------|------------|
| starr<br>rigid | ER 7130-32 |
|----------------|------------|

|                      |            |
|----------------------|------------|
| biegsam<br>malleable | ER 7131-32 |
|----------------------|------------|

4 mm

mit cm-Graduierung  
with cm graduation

1:3

VALLEIX

25 cm – 10"

|            |
|------------|
| ER 7135-25 |
|------------|

24 mm

Uterus-Depressor  
Uterine depressor

28 mm

BRAUN

28 cm – 11"

|            |
|------------|
| ER 7138-27 |
|------------|



18 cm – 7"  
ER 7159-03



BARRETT

25 cm – 10"  
ER 7162-25



BRAUN

25 cm – 10"  
ER 7164-25



COLLIN-POZZI

kräftiges Modell  
heavy pattern

25 cm – 10"  
ER 7160-25



SCHRÖDER

25,5 cm – 10"  
ER 7165-26



POZZI

25 cm – 10"  
ER 7166-28



S-gebogen  
S-curved

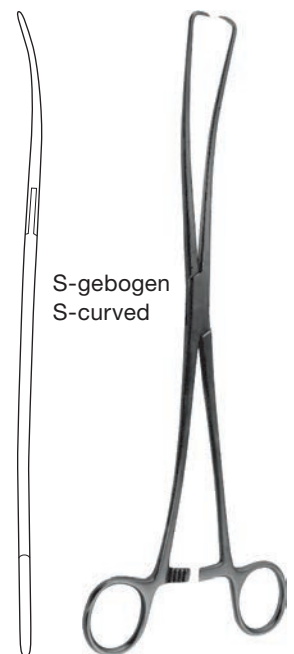

DUPLAY



Hakenzangen  
Uterine Tenaculum Forceps



Amniotom für die  
Amnionblase  
Amniotome for the  
amnion bladder

26 cm - 10 1/4"  
ER 7170-26

1:3  
BEACHAM



CZERNY



11 mm

20,5 cm - 8"  
ER 7175-20



gerade  
straight

20 cm - 8"  
24 cm - 9 1/2"  
ER 7180-24



2 : 2 Zähne  
2 : 2 teeth

SCHRÖDER

15,5 cm - 6"  
ER 7197-16



BRAUN





aufgebogen  
curved on lat

seitlich gebogen  
curved sideways

|             |            |            |
|-------------|------------|------------|
| 20 cm – 8"  |            |            |
| 24 cm – 9½" | ER 7181-24 | ER 7182-24 |

2 : 2 Zähne  
2 : 2 teeth



SCHRÖDER



gerade  
straight

24 cm – 9½"

|            |            |            |
|------------|------------|------------|
| 6 mm       | 8 mm       | 10 mm      |
| ER 7190-06 | ER 7190-08 | ER 7190-10 |



MUSEUX



gerade  
straight

21 cm – 8¼"

ER 7189-20



MUSEUX





Hakenzangen  
Uterine Tenaculum Forceps



26 cm – 10¼"  
ER 7178-26

PRATT



MUSEUX



seitlich gebogen  
curved sideways

24 cm – 9½"

|            |            |            |
|------------|------------|------------|
| 6 mm       | 8 mm       | 10 mm      |
| ER 7191-06 | ER 7191-08 | ER 7191-10 |



3 : 4 Zähne  
3 : 4 teeth

seitlich gebogen  
curved sideways

23 cm – 9"  
ER 7200-23

TEALE

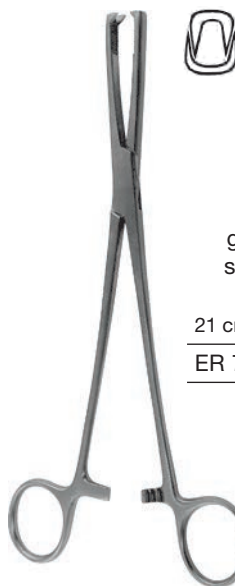

gerade  
straight

21 cm – 8¼"  
ER 7210-21

JACOBS



seitlich gebogen  
curved sideways

26 cm – 10¼"  
ER 7206-26

IOWA

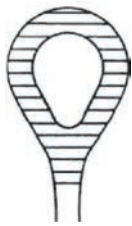

gerade  
straight

21 cm – 8¼"

ER 6616-20



HEYWOOD-SMITH

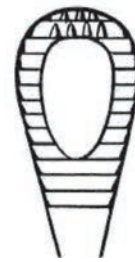

gerade  
straight

25 cm – 10"

ER 7218-25



HEYWOOD-SMITH



seitlich gebogen  
curved sideways

32 cm – 12½"

ER 7215-32

KELLY



gerade  
straight

27 cm – 10½"

ER 7219-27



NOTO





Uterus-Sekretlöffel,  
biegsam  
Uterine secretion spoon,  
malleable

26,5 cm – 10½"  
ER 6735-26



Fistelhaken  
Fistula hook

scharf  
sharp

22 cm – 8¾"  
ER 7230-22



Fistelhaken  
Fistula hook

scharf  
sharp

22 cm – 8¾"  
ER 7231-22



17 cm – 6¾"  
ER 7238-17



17 cm – 6¾"  
ER 7239-17



Myomheber  
Myoma screw



gerade  
straight

22,5 cm – 8¾"

ER 3383-01



leicht gebogen  
slightly curved

22 cm – 8¾"

ER 3383-02



stark gebogen  
strongly curved

21,5 cm – 8½"

ER 3383-03



gerade  
straight

25 cm – 10"

ER 3383-51



leicht gebogen  
slightly curved

24,5 cm – 9¾"

ER 3383-52



stark gebogen  
strongly curved

24 cm – 9½"

ER 3383-53



gebogen  
curved

23 cm – 9"

ER 3383-54



  
DE BAKEY Zahnung  
DE BAKEY Serration

WERTHEIM



1 Zahn  
1 tooth



1 Zahn  
1 tooth



1 Zahn  
1 tooth

gebogen  
curved

21 cm – 8¼"

ER 3384-21



2 Zähne  
2 teeth



2 Zähne  
2 teeth



2 Zähne  
2 teeth

gebogen  
curved

21 cm – 8¼"

ER 3385-21



HEANEY



1 Zahn  
1 tooth

gebogen  
curved

21 cm – 8¼"

ER 3384-41



HEANEY-SLIM





BALLENTINE



1 Zahn  
1 tooth

gerade  
straight

21 cm – 8¼"

ER 3386-01



HEANEY-BALLENTINE



1 Zahn  
1 tooth

gebogen  
curved

21 cm – 8¼"

ER 3386-11



PHANEUF



1 : 2 Zähne  
1 : 2 teeth



gerade  
straight

gebogen  
curved

21,5 cm – 8½"

ER 3388-20

ER 3389-20



WERTHEIM



gebogen  
curved

25 cm – 10"

1:3

ER 3430-25



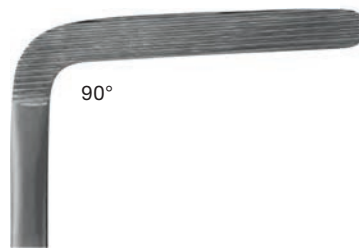

90°

gebogen  
curved

21,5 cm – 8½"

ER 3432-21



WERTHEIM-CULLEN



leicht gebogen  
slightly curved



gebogen  
curved

22 cm – 8¾"

ER 3435-22

ER 3436-22



1 : 2 Zähne  
1 : 2 teeth

WERTHEIM



Vaginalklemmen  
Vaginal Forceps



60 mm

23 cm - 9"

ER 3434-01

80 mm

23 cm - 9"

ER 3434-02

Biopsie Instrumente  
Biopsy Instruments

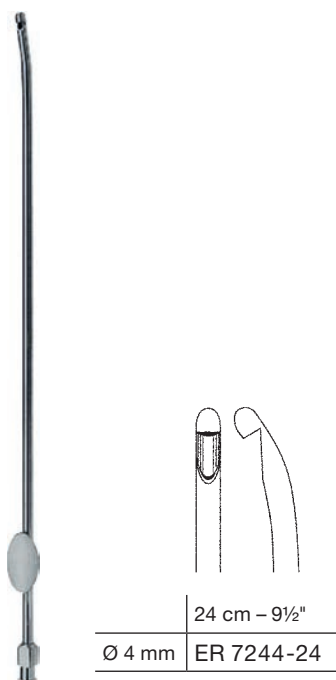

24 cm - 9½"

Ø 4 mm | ER 7244-24

RANDALL



23 cm – 9"  
ER 7250-23

GELLHORN 1:3



24 cm – 9½"  
ER 7252-24



THOMAS-GAYLOR 1:3



21 cm – 8¼"  
29 cm – 11½"  
ER 7255-29

SCHUBERT

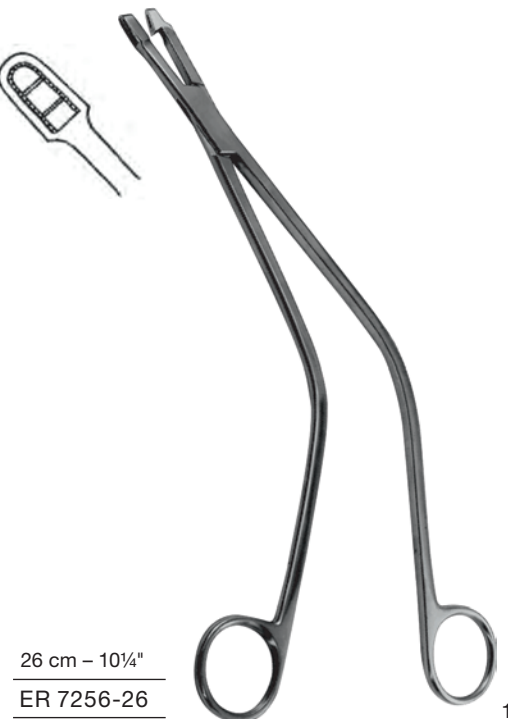

26 cm – 10¼"  
ER 7256-26

SCHUBERT 1:3



|  |                          |
|--|--------------------------|
|  | Bissbreite<br>Bite width |
|  | 3,5 / 4 x 7 mm           |

VAN DOREN

1:3

25 cm - 10"

ER 7258-01



FAURE

21 cm - 8 1/4"

ER 7263-21



SCHUMACHER

1:3



24 cm - 9 1/2"

Fig. 1

Fig. 2

ER 7261-24

ER 7262-24

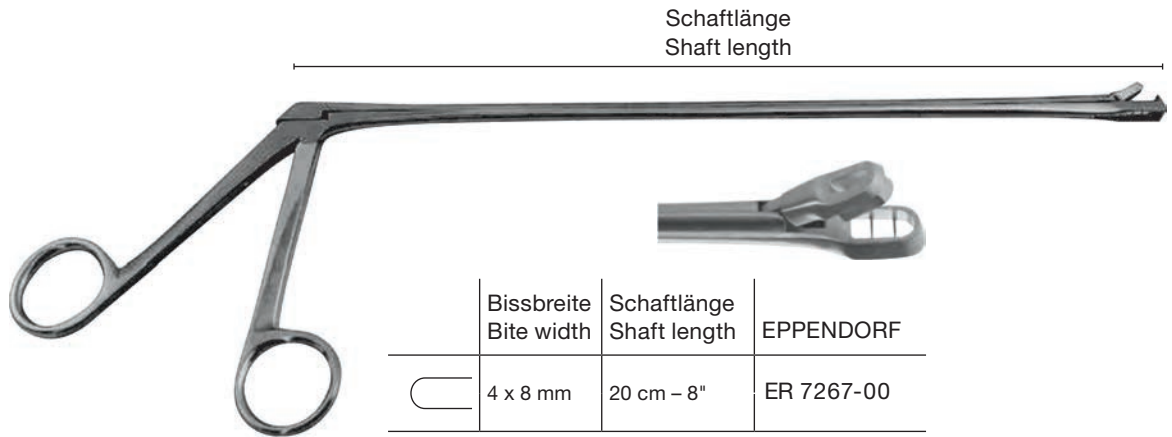

|  | Bissbreite<br>Bite width | Schaftlänge<br>Shaft length | EPPENDORF  |
|--|--------------------------|-----------------------------|------------|
|  | 4 x 8 mm                 | 20 cm - 8"                  | ER 7267-00 |



|  | Schaftlänge<br>Shaft length | Bissbreite<br>Bite width | SCHUMACHER |
|--|-----------------------------|--------------------------|------------|
|  | 24 cm - 9½"                 | 4 mm                     | ER 7265-00 |
|  | 24 cm - 9½"                 | 6 mm                     | ER 7265-06 |



|  | Bissbreite<br>Bite width | Schaftlänge<br>Shaft length | KEVORKIAN  |
|--|--------------------------|-----------------------------|------------|
|  | 3 x 8 mm                 | 24 cm - 9½"                 | ER 7266-00 |

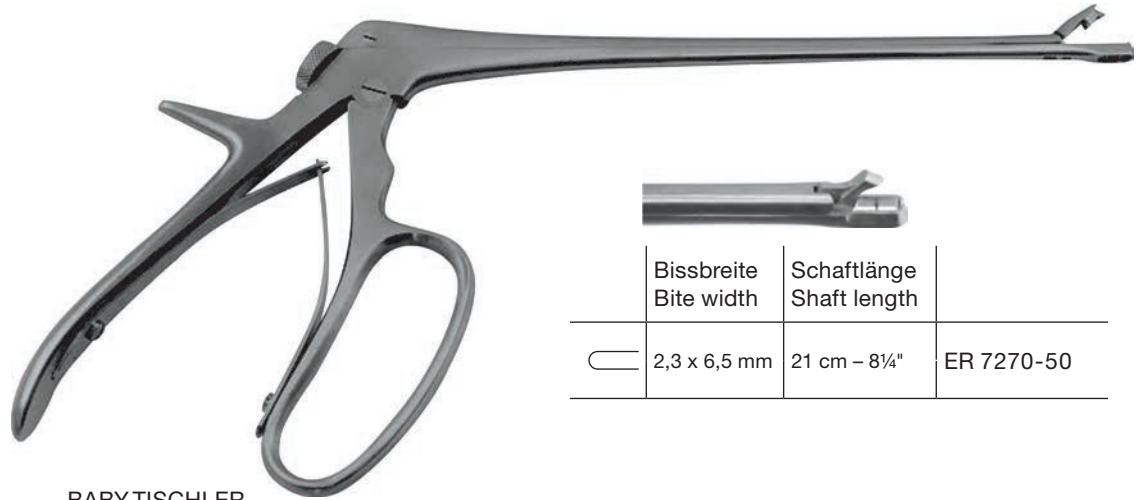

|  | Bissbreite<br>Bite width | Schaftlänge<br>Shaft length |            |
|--|--------------------------|-----------------------------|------------|
|  | 2,3 x 6,5 mm             | 21 cm - 8¼"                 | ER 7270-50 |

BABY-TISCHLER

### Uterus Biopsie Zangen Uterine Biopsy Forceps

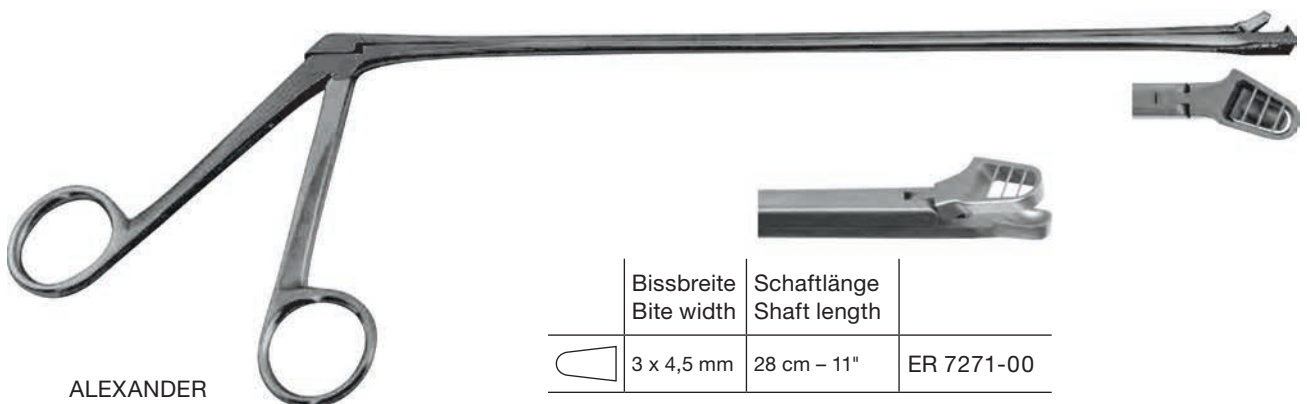

|  | Bissbreite<br>Bite width | Schaftlänge<br>Shaft length |            |
|--|--------------------------|-----------------------------|------------|
|  | 3 x 4,5 mm               | 28 cm - 11"                 | ER 7271-00 |

ALEXANDER



## Uteruslöffel Uterine Scoops



scharf, fest  
sharp, rigid

1:3  
SCHRÖDER



30 cm – 11¾"

| Fig. 1     | Fig. 2     | Fig. 3     | Fig. 4     | Fig. 5     | Fig. 6     |
|------------|------------|------------|------------|------------|------------|
| ER 7280-01 | ER 7280-02 | ER 7280-03 | ER 7280-04 | ER 7280-05 | ER 7280-06 |



scharf, fest  
sharp, rigid

1:3  
SIMON



25 cm – 10"

| Fig. 1     | Fig. 2     | Fig. 3     | Fig. 4     | Fig. 5     | Fig. 6     |
|------------|------------|------------|------------|------------|------------|
| ER 7282-01 | ER 7282-02 | ER 7282-03 | ER 7282-04 | ER 7282-05 | ER 7282-06 |



| 31 cm – 12¼" |      | biegsam<br>malleable | fest<br>rigid   | fest<br>rigid   |
|--------------|------|----------------------|-----------------|-----------------|
| Fig.         | mm   | scharf<br>sharp      | scharf<br>sharp | stumpf<br>blunt |
| 00           | 5,5  |                      | ER 7322-05      |                 |
| 0            | 7,5  |                      | ER 7322-07      | ER 7324-07      |
| 1            | 8,5  | ER 7318-08           | ER 7322-08      | ER 7324-08      |
| 2            | 10,5 | ER 7318-09           | ER 7322-09      | ER 7324-09      |
| 3            | 12   | ER 7318-12           | ER 7322-12      | ER 7324-12      |
| 4            | 14   | ER 7318-14           | ER 7322-14      | ER 7324-14      |
| 5            | 15   | ER 7318-15           | ER 7322-15      | ER 7324-15      |
| 6            | 16,5 | ER 7318-16           | ER 7322-16      | ER 7324-16      |
| 7            | 18   | ER 7318-19           | ER 7322-19      | ER 7324-19      |
| 8            | 19,5 | ER 7318-20           | ER 7322-20      | ER 7324-20      |
| 9            | 21,5 |                      | ER 7322-21      | ER 7324-21      |
| 10           | 23,5 |                      | ER 7322-23      | ER 7324-23      |
| 34 cm – 13½" |      |                      |                 |                 |
| 1            | 35   |                      |                 | ER 7324-35      |
| 2            | 40   |                      |                 | ER 7324-40      |

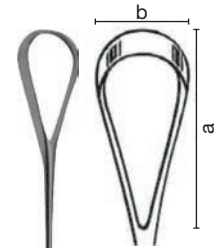

RECAMIER

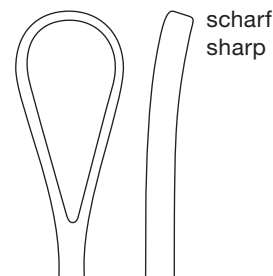

scharf  
sharp

27 cm – 10½"

ER 7330-27

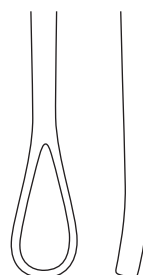

stumpf  
blunt



1:3  
BLAKE





## Uterusküretten Uterine Curettes



28 cm – 11"

|                                     | Fig. 1      | Fig. 2        | Fig. 3       | Fig. 4     | Fig. 5     | Fig. 6     |
|-------------------------------------|-------------|---------------|--------------|------------|------------|------------|
| a x b                               | 15 x 7,5 mm | 17,5 x 8,5 mm | 20 x 10,5 mm | 22 x 12 mm | 24 x 14 mm | 28 x 15 mm |
| biegsam, scharf<br>malleable, sharp | ER 7300-01  | ER 7300-02    | ER 7300-03   | ER 7300-04 | ER 7300-05 | ER 7300-06 |
| biegsam, stumpf<br>malleable, blunt | ER 7302-01  | ER 7302-02    | ER 7302-03   | ER 7302-04 | ER 7302-05 | ER 7302-06 |
| fest, scharf<br>rigid, sharp        | ER 7304-01  | ER 7304-02    | ER 7304-03   | ER 7304-04 | ER 7304-05 | ER 7304-06 |
| fest, stumpf<br>rigid, blunt        | ER 7306-01  | ER 7306-02    | ER 7306-03   | ER 7306-04 | ER 7306-05 | ER 7306-06 |

SIMS

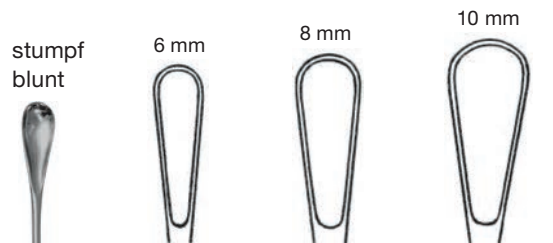

28 cm – 11"

| Fig. 1     | Fig. 2     | Fig. 3     |
|------------|------------|------------|
| ER 7281-01 | ER 7281-02 | ER 7281-03 |

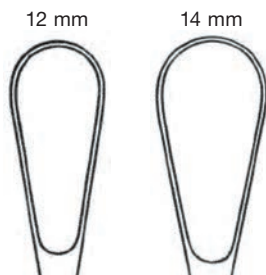

28 cm – 11"

| Fig. 4     | Fig. 5     |
|------------|------------|
| ER 7281-04 | ER 7281-05 |

GOURDET



29 cm – 11½"

| Fig. | mm   | stumpf<br>blunt |
|------|------|-----------------|
| 0    | 16   | ER 7326-16      |
| 1    | 18   | ER 7326-18      |
| 2    | 19,5 | ER 7326-20      |
| 3    | 21,5 | ER 7326-22      |
| 4    | 23,5 | ER 7326-23      |
| 5    | 26   | ER 7326-26      |
| 6    | 28,5 | ER 7326-28      |

RECAMIER



Schlauch-Verbindungsstück  
Tube connecting piece

ER 7289-50



| Ø mm | 28 cm – 11" |
|------|-------------|
| 4    | ER 7289-04  |
| 6    | ER 7289-06  |
| 8    | ER 7289-08  |
| 10   | ER 7289-10  |
| 12   | ER 7289-12  |
| 14   | ER 7289-14  |



graduiert  
graduated

Salpingograph  
Salpingograph



SCHULTZE

|   |            |
|---|------------|
| Salpingograph zur Hystereo-Salpingographie<br>komplett in Holzetui, bestehend aus:<br>Salpingograph for utero-salpingography<br>complete in wooden case, consisting of: | ER 7350-00 |
|---|------------|

- 1 Manometer (ER 7350-01)
- 1 Manometer (ER 7350-01)
- 1 Zwischenstück, ohne Manometer (ER 7350-02)
- 1 Connection, without manometer (ER 7350-02)
- 1 Tubenkatheter mit Hahn, ohne Kugel (ER 7350-03)
- 1 Uterine cannula with tap, without cone (ER 7350-03)
- 1 Kegel, klein (ER 7350-04)
- 1 Cone, small (ER 7350-04)
- 1 Kegel, mittel (ER 7350-05)
- 1 Cone, medium (ER 7350-05)
- 1 Kegel, groß (ER 7350-06)
- 1 Cone, large (ER 7350-06)
- 1 Holzetui (ER 7350-20)
- 1 Wooden case (ER 7350-20)



SCHULTZE

|   |            |
|---|------------|
| Salpingograph zur Hystereo-Salpingographie<br>komplett in Holzetui, bestehend aus:<br>Salpingograph for utero-salpingography<br>complete in wooden case, consisting of: | ER 7360-00 |
|---|------------|

- 1 Zwischenstück, ohne Manometer (ER 7350-02)
- 1 Connection, without manometer (ER 7350-02)
- 1 Tubenkatheter mit Hahn, ohne Kugel (ER 7350-03)
- 1 Uterine cannula with tap, without cone (ER 7350-03)
- 1 Kegel, klein (ER 7350-04)
- 1 Cone, small (ER 7350-04)
- 1 Kegel, mittel (ER 7350-05)
- 1 Cone, medium (ER 7350-05)
- 1 Kegel, groß (ER 7350-06)
- 1 Cone, large ER 7350-06)
- 1 Holzetui (ER 7350-20)
- 1 Wooden case (ER 7350-20)



Manometer  
Manometer

ER 7350-01



Zwischenstück  
Connection

ER 7350-02



Tubenkatheter  
mit Hahn, ohne Kugel  
Uterine cannula  
with tap, without cone

ER 7350-03



klein  
small

ER 7350-04



mittel  
medium

ER 7350-05



groß  
large

ER 7350-06



DE MARTEL (WILLET)

19 cm – 7½"  
ER 7420-19



SELLHEIM

Geburtslöffel  
Elevating spoon

28 cm – 11"  
ER 7425-28



COLLIN

Nabelschnurklemme  
Umbilical cord clamp

9 cm – 3½"  
ER 7436-29



36 cm – 14¼"  
ER 7446-36

1:4  
SIMPSON-BRAUN



23 cm – 9"  
ER 7445-23

1:4  
SIMPSON



30 cm – 11¼"  
ER 7445-30

1:4  
SIMPSON

mit Achsenzugvorrichtung  
Forceps with traction rod



43,5 cm – 17¼"  
ER 7475-40

TARNIER



23 cm – 9" | 28 cm – 11"  
ER 7442-23 | ER 7442-28

1:4  
WRIGLEY



NÄGELE

|              |            |
|--------------|------------|
| 36 cm – 14¼" | ER 7440-36 |
| 40 cm – 15¾" | ER 7440-40 |



KIELLAND

|              |            |
|--------------|------------|
| 41 cm – 16¼" | ER 7460-41 |
|--------------|------------|



PIPER

für nachkommenden  
Kopf bei Steisslagen  
for delivery of the after  
coming head in breech  
presentation

|              |            |
|--------------|------------|
| 44 cm – 17¼" | ER 7472-44 |
|--------------|------------|

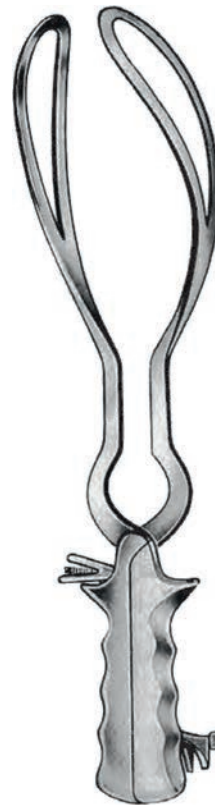

BARNES-NEVILLE

mit Zugvorrichtung  
with traction appliance

|                |            |
|----------------|------------|
| 43,5 cm – 17¼" | ER 7474-43 |
|----------------|------------|





gerade  
straight

28 cm – 11"

|            |            |            |
|------------|------------|------------|
| ER 7410-01 | ER 7410-02 | ER 7410-03 |
|------------|------------|------------|



WINTER

1:3



gebogen  
curved

28 cm – 11"

|            |            |            |
|------------|------------|------------|
| ER 7411-01 | ER 7411-02 | ER 7411-03 |
|------------|------------|------------|



WINTER

1:3



Abortus- und Plazentanzangen  
Ovum and Placenta Forceps



SÄNGER

1:3

Abortuszangen  
Ovum forceps



gerade  
straight

27,5 cm – 10¾"

ER 7414-27

gebogen  
curved

26,5 cm – 10½"

ER 7415-27

Uterusklemmzangen  
Uterine Forceps



GREEN-ARMYTAGE



21 cm – 8¼"

ER 7418-21



**Meißel und Osteotome / Chisels and Osteotomes**

**Scharfe Löffel / Bone Curettes**

**Knochenraspel / Bone Rasps**

**Rasparatorien / Raspatories**

**Elevatorien / Elevators**

**Knochenhebel / Bone Levers**

**Knochenhaken / Bone Retractors**

**Spinalhaken, Meniskusmesser / Spinal Retractors, Meniscectomy Knives**

**Knochenhaltezangen / Bone Holding Forceps**

**Hohlmeißelzangen / Bone Rongeur Forceps**

**Knochensplitterzangen / Bone Cutting Forceps**

**Instrumente für Fingernägel / Nail Instruments**

**Sägen und Sägeblätter / Saws and Saw Blades**

**Bohrapparate / Hand Drills**

**Reibahlen / Awls**

**Bohrdrähte, Steinmann-Nägel / Drill Wires, Steinmann Pins**

**Drahtspannzangen / Wire Twisting Forceps**

**Drahtfasszangen / Wire Holding Forceps**

**Flachzangen / Flat Nosed Pliers**

**Drahtschneidezangen / Wire Cutting Pliers**

**Extensionsbügel / Extension Bows**

**Cerclage-Instrumente / Cerclage Instruments**

**Hämmer / Mallets**

**Sehneninstrumente / Tendon Instruments**

## Knochenchirurgie *Bone Surgery*





## Meißel und Osteotome Chisels and Osteotomes



Schlüssel SW 3  
Wrench SW 3  
ER 5301-06



Griff mit Schraube SW 3  
Handle with screw SW 3  
ER 5301-00



5 mm  
ER 5301-05



10 mm  
ER 5301-10



16 mm  
ER 5301-16



25 mm  
ER 5301-25

Satz Meißel komplett, bestehend aus:  
Chisel set complete, consisting of:

- 1 Griff (ER 5301-00)
- 1 Handle (ER 5301-00)
- 1 Meißelklinge, 10 mm (ER 5301-10)
- 1 Chisel blade, 10 mm (ER 5301-10)
- 1 Meißelklinge, 16 mm (ER 5301-16)
- 1 Chisel blade, 16 mm (ER 5301-16)
- 1 Meißelklinge, 25 mm (ER 5301-25)
- 1 Chisel blade, 25 mm (ER 5301-25)
- 1 Schlüssel (ER 5301-06)
- 1 Wrench (ER 5301-06)

Meißelklinge, 5 mm (ER 5301-05) optional  
Chisel blade, 5 mm (ER 5301-05) optional

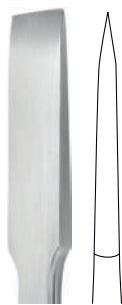

gerade  
straight

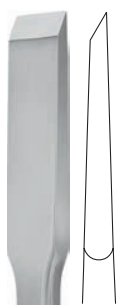

gerade  
straight



gerade  
straight

|       | Osteotome<br>Osteotomes | Flachmeißel<br>Chisels | Hohlmeißel<br>Gouges |
|-------|-------------------------|------------------------|----------------------|
|       | 13,5 cm – 5 1/4"        |                        |                      |
| 4 mm  | ER 5300-04              | ER 5302-04             | ER 5304-04           |
| 6 mm  | ER 5300-06              | ER 5302-06             | ER 5304-06           |
| 8 mm  | ER 5300-08              | ER 5302-08             | ER 5304-08           |
| 10 mm | ER 5300-10              | ER 5302-10             | ER 5304-10           |
| 12 mm | ER 5300-12              | ER 5302-12             | ER 5304-12           |



LUCAS



gerade  
straight



gerade  
straight

|      | Flachmeißel<br>Chisels | Hohlmeißel<br>Gouges |
|------|------------------------|----------------------|
|      | 16 cm – 6 1/4"         |                      |
| 5 mm | ER 5305-34             | ER 5305-44           |
| 3 mm | ER 5305-36             | ER 5305-46           |



|      |             |            |
|------|-------------|------------|
| 3 mm | 14 cm – 5½" | ER 5308-03 |
| 4 mm | 14 cm – 5½" | ER 5308-04 |
| 5 mm | 14 cm – 5½" | ER 5308-05 |
| 6 mm | 14 cm – 5½" | ER 5308-06 |
| 3 mm | 17 cm – 6¾" | ER 5310-03 |
| 4 mm | 17 cm – 6¾" | ER 5310-04 |
| 5 mm | 17 cm – 6¾" | ER 5310-05 |
| 6 mm | 17 cm – 6¾" | ER 5310-06 |
| 7 mm | 17 cm – 6¾" | ER 5310-07 |
| 3 mm | 14 cm – 5½" | ER 5314-03 |
| 4 mm | 14 cm – 5½" | ER 5314-04 |
| 5 mm | 14 cm – 5½" | ER 5314-05 |
| 6 mm | 14 cm – 5½" | ER 5314-06 |
| 3 mm | 17 cm – 6¾" | ER 5316-03 |
| 4 mm | 17 cm – 6¾" | ER 5316-04 |
| 5 mm | 17 cm – 6¾" | ER 5316-05 |
| 6 mm | 17 cm – 6¾" | ER 5316-06 |
| 7 mm | 17 cm – 6¾" | ER 5316-07 |



PARTSCH

Stößel  
Tamper

|             |            |
|-------------|------------|
| 3 mm        | 5 mm       |
| 16 cm – 6¼" |            |
| ER 5317-03  | ER 5317-05 |
| 7 mm        | 9 mm       |
| 16 cm – 6¼" |            |
| ER 5317-07  | ER 5317-09 |



gerade  
straight



gerade  
straight

|       | Flachmeißel<br>Chisels | Hohlmeißel<br>Gouges |
|-------|------------------------|----------------------|
|       | 17,5 cm – 6¾"          |                      |
| 4 mm  | ER 5320-04             | ER 5322-04           |
| 6 mm  | ER 5320-06             | ER 5322-06           |
| 8 mm  | ER 5320-08             | ER 5322-08           |
| 10 mm | ER 5320-10             | ER 5322-10           |
| 12 mm | ER 5320-12             | ER 5322-12           |
| 14 mm | ER 5320-14             | ER 5322-14           |



ALEXANDER



gerade  
straight



gebogen  
curved

|      | Osteotome<br>Osteotomes | Osteotome<br>Osteotomes |
|------|-------------------------|-------------------------|
|      | 14 cm – 5½"             |                         |
| 3 mm | ER 5321-02              | ER 5321-12              |
| 5 mm | ER 5321-04              | ER 5321-14              |
| 6 mm | ER 5321-05              | ER 5321-15              |
| 8 mm | ER 5321-06              | ER 5321-16              |
| 9 mm | ER 5321-07              | ER 5321-17              |



HOKE



## Meißel und Osteotome Chisels and Osteotomes

Osteotome mit Markierung  
Osteotomes with depth marking



gerade  
straight

18 cm – 7"

|       |            |
|-------|------------|
| 2 mm  | ER 8253-02 |
| 4 mm  | ER 8253-04 |
| 6 mm  | ER 8253-06 |
| 8 mm  | ER 8253-07 |
| 10 mm | ER 8253-09 |
| 12 mm | ER 8253-12 |

COTTLE

Flachmeißel mit Markierung  
Chisels with depth marking



gerade  
straight

18 cm – 7"

|       |            |
|-------|------------|
| 4 mm  | ER 8258-04 |
| 7 mm  | ER 8258-07 |
| 9 mm  | ER 8258-09 |
| 12 mm | ER 8258-12 |

COTTLE



gerade  
straight

gebogen  
curved

gerade  
straight

gebogen  
curved

|       | Osteotome<br>Osteotomes |            | Hohlmeißel<br>Gouges |            |
|-------|-------------------------|------------|----------------------|------------|
|       | 20,5 cm – 8"            |            |                      |            |
| 6 mm  | ER 5323-06              | ER 5325-06 |                      |            |
| 9 mm  | ER 5323-09              | ER 5325-09 | ER 5327-09           | ER 5329-09 |
| 13 mm | ER 5323-13              | ER 5325-13 | ER 5327-13           | ER 5329-13 |
| 16 mm | ER 5323-16              | ER 5325-16 |                      |            |
| 19 mm | ER 5323-19              | ER 5325-19 | ER 5327-19           | ER 5329-19 |
| 25 mm | ER 5323-25              | ER 5325-25 | ER 5327-25           | ER 5329-25 |
| 32 mm | ER 5323-32              | ER 5325-32 |                      |            |

SMITH-PETERSEN



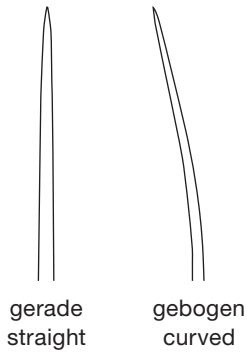

|       |            | Osteotome<br>Osteotomes |  |
|-------|------------|-------------------------|--|
|       |            | 24,5 cm – 9¾"           |  |
| 4 mm  | ER 5330-04 |                         |  |
| 8 mm  | ER 5330-08 | ER 5331-08              |  |
| 10 mm | ER 5330-10 |                         |  |
| 13 mm | ER 5330-13 | ER 5331-13              |  |
| 15 mm | ER 5330-16 |                         |  |
| 18 mm | ER 5330-18 | ER 5331-18              |  |
| 20 mm | ER 5330-20 |                         |  |
| 25 mm | ER 5330-25 | ER 5331-25              |  |
| 30 mm | ER 5330-30 | ER 5331-30              |  |
| 38 mm | ER 5330-38 | ER 5331-38              |  |
| 44 mm | ER 5330-44 |                         |  |
| 50 mm | ER 5330-50 |                         |  |



LAMBOTTE

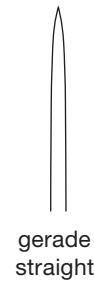

|       |            | Osteotome<br>Osteotomes |             |
|-------|------------|-------------------------|-------------|
|       |            | 13,5 cm – 5¼"           | 17 cm – 6¾" |
| 2 mm  | ER 5332-02 | ER 5333-02              |             |
| 3 mm  | ER 5332-03 | ER 5333-03              |             |
| 4 mm  | ER 5332-04 | ER 5333-04              |             |
| 6 mm  | ER 5332-06 | ER 5333-06              |             |
| 8 mm  | ER 5332-08 | ER 5333-08              |             |
| 10 mm | ER 5332-10 | ER 5333-10              |             |
| 12 mm | ER 5332-12 | ER 5333-12              |             |
| 15 mm | ER 5332-15 | ER 5333-15              |             |



MINI-LAMBOTTE



|      |            | 16 cm – 6¼" |
|------|------------|-------------|
| 4 mm | ER 8244-16 |             |



FREER



|      |            | 16 cm – 6¼" |
|------|------------|-------------|
| 4 mm | ER 8245-16 |             |



FREER





gerade  
straight



gerade  
straight



LEXER  
MINI-LEXER

|       | Osteotome<br>Osteotomes | Hohlmeißel<br>Gouges |
|-------|-------------------------|----------------------|
|       | 18 cm – 7"              |                      |
| 4 mm  | ER 5334-04              | ER 5335-04           |
| 6 mm  | ER 5334-06              | ER 5335-06           |
| 8 mm  | ER 5334-08              | ER 5335-08           |
| 10 mm | ER 5334-10              | ER 5335-10           |
| 12 mm | ER 5334-12              | ER 5335-12           |



gerade  
straight



gerade  
straight

|       | Osteotome<br>Osteotomes | Hohlmeißel<br>Gouges |
|-------|-------------------------|----------------------|
|       | 22 cm – 8¾"             |                      |
| 5 mm  | ER 5336-05              | ER 5338-05           |
| 7 mm  | ER 5336-07              | ER 5338-07           |
| 10 mm | ER 5336-10              | ER 5338-10           |
| 15 mm | ER 5336-15              | ER 5338-15           |
| 20 mm | ER 5336-20              | ER 5338-20           |
| 25 mm | ER 5336-25              | ER 5338-25           |
| 30 mm | ER 5336-30              | ER 5338-30           |



gerade  
straight



gerade  
straight



gebogen  
curved



gerade  
straight

|       | Flachmeißel<br>Chisels | Osteotome<br>Osteotomes | Hohlmeißel<br>Gouges |
|-------|------------------------|-------------------------|----------------------|
|       | 20 cm – 8"             |                         |                      |
| 10 mm | ER 5340-10             | ER 5341-10              | ER 5342-10           |
| 12 mm | ER 5340-12             | ER 5341-12              | ER 5342-12           |
| 15 mm | ER 5340-15             | ER 5341-15              | ER 5342-15           |
| 20 mm | ER 5340-20             | ER 5341-20              | ER 5342-20           |
| 25 mm | ER 5340-25             | ER 5341-25              | ER 5342-25           |



STILLE



gerade  
straight



gebogen  
curved



gerade  
straight



gebogen  
curved



gerade  
straight



gebogen  
curved

|       | Osteotome<br>Osteotomes |            | Flachmeißel<br>Chisels |            | Hohlmeißel<br>Gouges |            |
|-------|-------------------------|------------|------------------------|------------|----------------------|------------|
|       | 24 cm – 9½"             |            | 24 cm – 9½"            |            | 24 cm – 9½"          |            |
| 6 mm  | ER 5344-06              | ER 5344-56 | ER 5345-06             | ER 5345-56 | ER 5346-06           | ER 5346-56 |
| 13 mm | ER 5344-13              | ER 5344-63 | ER 5345-13             | ER 5345-63 | ER 5346-13           | ER 5346-63 |
| 19 mm | ER 5344-19              | ER 5344-69 | ER 5345-19             | ER 5345-69 | ER 5346-19           | ER 5346-69 |
| 25 mm | ER 5344-25              | ER 5344-75 | ER 5345-25             | ER 5345-75 | ER 5346-25           | ER 5346-75 |
| 32 mm | ER 5344-32              | ER 5344-82 | ER 5345-32             | ER 5345-82 | ER 5346-32           | ER 5346-82 |



1:3  
HIBBS



gerade  
straight



LEXER

| Hohlmeißel<br>Gouges |            |
|----------------------|------------|
| 25 cm – 10"          |            |
| 5 mm                 | ER 5348-05 |
| 10 mm                | ER 5348-10 |
| 15 mm                | ER 5348-15 |

gebogen  
curved



LEXER

| Hohlmeißel<br>Gouges |            |
|----------------------|------------|
| 25 cm – 10"          |            |
| 5 mm                 | ER 5348-55 |
| 10 mm                | ER 5348-60 |
| 15 mm                | ER 5348-65 |



Fig. 0000 – 2,5 mm

ER 5350-40

Fig. 000 – 3,6 mm

ER 5350-30

Fig. 00 – 4,4 mm

ER 5350-20

Fig. 0 – 5,2 mm

ER 5350-10

Fig. 1 – 6,8 mm

ER 5350-01

Fig. 2 – 8,5 mm

ER 5350-02

Fig. 3 – 10 mm

ER 5350-03

Fig. 4 – 11,5 mm

ER 5350-04

Fig. 5 – 13 mm

ER 5350-05

Fig. 6 – 14,5 mm

ER 5350-06



**VOLKMANN**  
17 cm – 6¾"



Fig. 000 – 3,3 mm

ER 5351-08 | ER 5351-58

Fig. 00 – 3,9 mm

ER 5351-09 | ER 5351-59

Fig. 0 – 4,7 mm

ER 5351-10 | ER 5351-60

Fig. 1 – 5,3 mm

ER 5351-11 | ER 5351-61

Fig. 2 – 6 mm

ER 5351-12 | ER 5351-62

Fig. 3 – 7,2 mm

ER 5351-13 | ER 5351-63

Fig. 4 – 8,2 mm

ER 5351-14 | ER 5351-64

Fig. 5 – 9,8 mm

ER 5351-15 | ER 5351-65

Fig. 6 – 12 mm

ER 5351-16 | ER 5351-66



**BRUNS**  
23 cm – 9"



Fig. 000 – 3,3 mm

○ ER 5352-30



Fig. 0000 – 2,5 mm

○ ER 5353-40

Fig. 00 – 4,8 mm

○ ER 5352-20

Fig. 000 – 2,8 mm

○ ER 5353-30

Fig. 0 – 5,8 mm

○ ER 5352-10

Fig. 00 – 3,3 mm

○ ER 5353-20

Fig. 1 – 7,3 mm

○ ER 5352-01

Fig. 0 – 3,7 mm

○ ER 5353-10

Fig. 2 – 8,3 mm

○ ER 5352-02

Fig. 1 – 4,3 mm

○ ER 5353-01

Fig. 3 – 10,2 mm

○ ER 5352-03

Fig. 2 – 4,8 mm

○ ER 5353-02

Fig. 4 – 11,8 mm

○ ER 5352-04

Fig. 3 – 5,6 mm

○ ER 5353-03

Fig. 5 – 12,8 mm

○ ER 5352-05

Fig. 4 – 6,1 mm

○ ER 5353-04

Fig. 6 – 14 mm

○ ER 5352-06

SPRATT

17 cm – 6¾"

Fig. 5 – 6,7 mm

○ ER 5353-05



BRUNS

17 cm – 6¾"



SPRATT

17 cm – 6¾"



Fig. 00 – 2,5 mm  
ER 5356-20

Fig. 0 – 3,2 mm  
ER 5356-10

Fig. 1 – 4 mm  
ER 5356-01

Fig. 2 – 5,7 mm  
ER 5356-02



**WILLIGER**  
17 cm – 6¾"



**UFFENRODE**

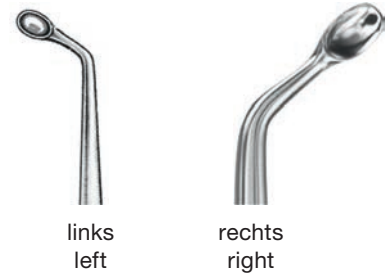

links left  
rechts right

17 cm – 6¾"  
ER 5357-01 | ER 5357-02

Fig. 000 – 3,3 mm  
ER 5355-30

Fig. 00 – 4 mm  
ER 5355-20

Fig. 0 – 5 mm  
ER 5355-10

Fig. 1 – 5,6 mm  
ER 5355-01

Fig. 2 – 6,5 mm  
ER 5355-02

Fig. 3 – 7,5 mm  
ER 5355-03

Fig. 4 – 8 mm  
ER 5355-04



**SCHEDE**  
17 cm – 6¾"

Fig. 0 – 4,4 mm  
ER 5358-10

Fig. 1 – 6,8 mm  
ER 5358-01

Fig. 2 – 8,5 mm  
ER 5358-02

Fig. 3 – 10 mm  
ER 5358-03



**VOLKMANN**  
28 cm – 11"

Fig. 00 – 2,8 mm  
ER 5361-20

Fig. 0 – 3,6 mm  
ER 5361-10

Fig. 1 – 4,4 mm  
ER 5361-01

Fig. 2 – 5,2 mm  
ER 5361-02



**DAUBENSPECK**  
20 cm – 8"



## Scharfe Löffel Bone Currettes

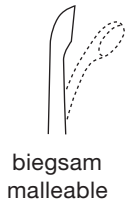

Fig. 1 – 4,8 mm  
ER 5362-01

Fig. 2 – 5,8 mm  
ER 5362-02

Fig. 3 – 6,8 mm  
ER 5362-03

**HALLE**  
21 cm – 8¼"



Fig. 000 – 3,6 mm  
25 cm – 10"

ER 5363-01 | ER 5363-11

Fig. 00 – 4,4 mm  
25 cm – 10"

ER 5363-02 | ER 5363-12

Fig. 0 – 5,2 mm  
25 cm – 10"

ER 5363-03 | ER 5363-13

Fig. 1 – 6 mm  
25 cm – 10"

ER 5363-04 | ER 5363-14



13 cm – 5" | 14,5 cm – 5¾"  
ER 5364-13 | ER 5364-14



17 cm – 6¾"  
ER 5364-17



**VOLKMANN**

oval  
oval



rund  
round

**VOLKMANN**

13 cm – 5" | ER 5365-13  
16 cm – 6¼" | ER 5365-16  
20 cm – 8" | ER 5365-20





Ø 3,1 / 2,6 mm  
ER 5366-00



Ø 4,2 / 3,1 mm  
ER 5366-01



Ø 4,8 / 4,2 mm  
ER 5366-12



MARTINI  
13,5 cm – 5¼"



Ø 3 / 2,5 mm  
ER 5368-00



Ø 3,5 / 3 mm  
ER 5368-01



Ø 4,2 / 3,5 mm  
ER 5368-12



WILLIGER  
13,5 cm – 5¼"



Ø 4,5 / 3,5 mm  
ER 7921-15

JANSEN  
15 cm – 6"



Ø 2,5 / 2 mm  
ER 7922-18



BARTH  
18 cm – 7"



Ø 6,5 / 6,2 mm  
ER 5370-21



WILLIGER  
20,5 cm – 8"



## Knochenraspeln Bone Rasps

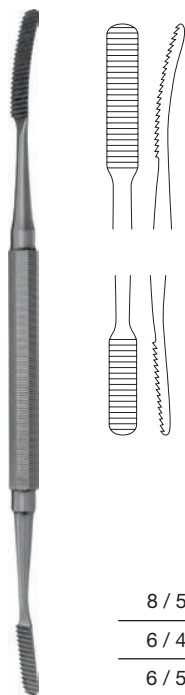

MILLER

18 cm – 7"

|            |            |
|------------|------------|
| 8 / 5 mm   | ER 5374-01 |
| 6 / 4,3 mm | ER 5374-02 |
| 6 / 5 mm   | ER 5374-03 |



PUTTI

30 cm – 11¾"

ER 5375-30



PUTTI

27 cm – 10½"

ER 5376-27

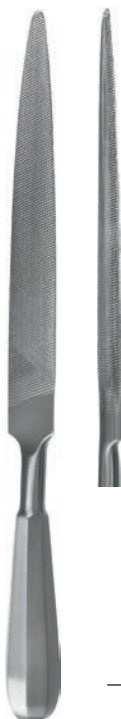

28 cm – 11"

ER 5377-25



25 cm – 10"

ER 5378-24



22 cm – 8¾"

ER 5379-22





## Raspatorien Raspatories



scharf,  
leicht gebogen  
sharp,  
slightly curved

|       |               |
|-------|---------------|
|       | 21,5 cm – 8½" |
| 5 mm  | ER 5385-05    |
| 10 mm | ER 5385-10    |
| 15 mm | ER 5385-15    |
| 20 mm | ER 5385-20    |
| 25 mm | ER 5385-25    |

LAMBOTTE



20 cm – 8"  
ER 5387-20

ALEXANDER

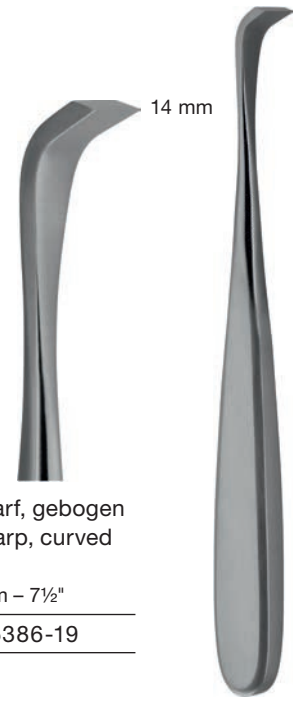

scharf, gebogen  
sharp, curved

19 cm – 7½"  
ER 5386-19

SCHNEIDER-SAUERBRUCH



scharf, gebogen  
sharp, curved

14 cm – 5½"  
ER 5390-13

WILLIGER



scharf, gebogen  
sharp, curved

16 cm – 6¼"  
ER 5392-16

WILLIGER



scharf,  
leicht gebogen  
sharp,  
slightly curved

16,5 cm – 6½"  
ER 5388-16

JANZEN



scharf,  
leicht gebogen  
sharp,  
slightly curved

16,5 cm – 6½"

ER 8206-16



JOSEPH



scharf,  
leicht gebogen  
sharp,  
slightly curved

19,5 cm – 7¾"

ER 8210-19



COTTLE



scharf  
sharp



scharf  
sharp

17 cm – 6¾"

ER 5393-01

ER 5393-03



stumpf  
blunt



scharf  
sharp

17 cm – 6¾"

ER 5393-02

ER 5393-04



ADSON



scharf, gebogen  
sharp, curved

17 cm – 6¾"

6 mm ER 5394-06

8 mm ER 5394-08





SEMBA



|               |            |            |            |            |
|---------------|------------|------------|------------|------------|
| 19,5 cm – 7¾" | 23 cm – 9" | 23 cm – 9" | 23 cm – 9" | 23 cm – 9" |
| ER 5398-01    | ER 5398-02 | ER 5398-04 | ER 5398-05 | ER 5398-07 |



DOYEN

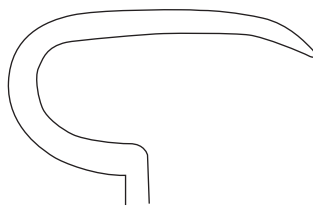

17 cm – 6¾"

ER 5400-01

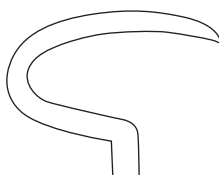

17 cm – 6¾"

ER 5402-01



DOYEN

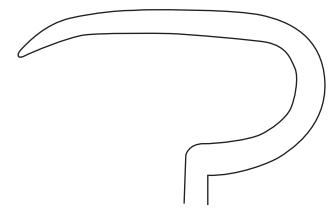

17 cm – 6¾"

ER 5400-02

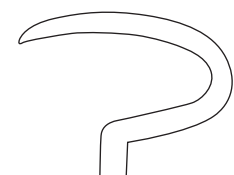

17 cm – 6¾"

ER 5402-02

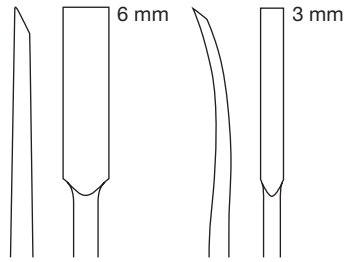

18,5 cm – 7¼"

ER 5410-01

ER 5410-02

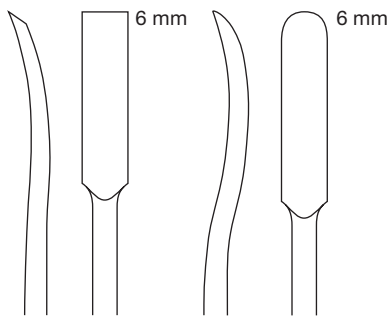

18,5 cm – 7¼"

ER 5410-03

ER 5410-04



scharf, gebogen  
sharp, curved

25 cm – 10"

10 mm ER 5412-10

13 mm ER 5412-11

19 mm ER 5412-14

25 mm ER 5412-17



COBB

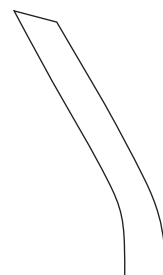
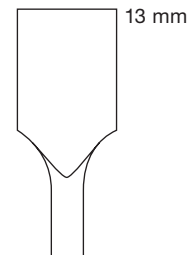

gewinkelt  
angled

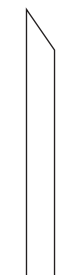

gerade  
straight

19 cm – 7½"

ER 5410-05

ER 5410-15







Raspatorien  
Raspatories

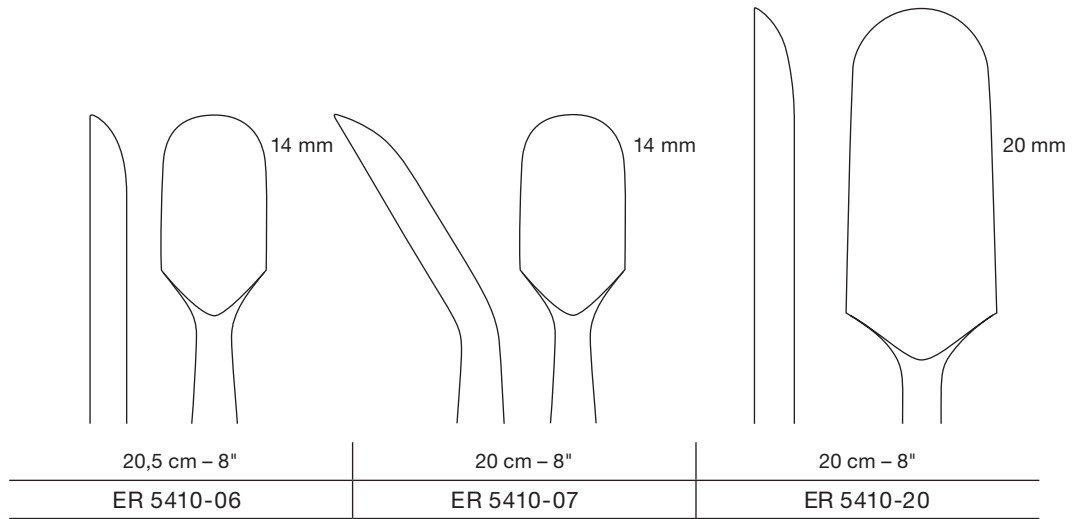

Stahl-Griff  
Steel handle



scharf, gebogen  
sharp, curved

|       |              |
|-------|--------------|
|       | 29 cm – 11½" |
| 10 mm | ER 5412-50   |
| 13 mm | ER 5412-51   |
| 19 mm | ER 5412-54   |

1:3  
COBB



gebogen, stumpf  
curved, blunt

20 cm – 8"

ER 5420-20 | ER 5421-20



LANGENBECK



halbscharf,  
gebogen  
semi-sharp,  
curved

16 cm – 6¼"

7 mm | ER 5418-01

18 cm – 7"

15 mm | ER 5418-03

19 cm – 7½"

20 mm | ER 5418-05



HOEN



gebogen,  
stumpf  
curved,  
blunt

23 cm – 9"

ER 5422-23



LANGENBECK



## Elevatoren Elevators



6,5 mm

gebogen,  
stumpf  
curved,  
blunt

17 cm – 6¾"

ER 5425-17

WILLIGER



5 mm

gebogen,  
stumpf  
curved,  
blunt

16 cm – 6¼"

ER 5426-16

WILLIGER



6 mm

gebogen,  
stumpf  
curved,  
blunt

19,5 cm – 7¾"

ER 5427-20

QUERVAIN



|             |       |            |
|-------------|-------|------------|
| 18 cm – 7"  | 6 mm  | ER 5430-06 |
| 19 cm – 7½" | 10 mm | ER 5430-10 |
|             | 13 mm | ER 5430-12 |
| 20 cm – 8"  | 19 mm | ER 5430-19 |
|             | 25 mm | ER 5430-25 |

KEY



scharf  
sharp



20 cm – 8"

ER 8237-20

COTTLE

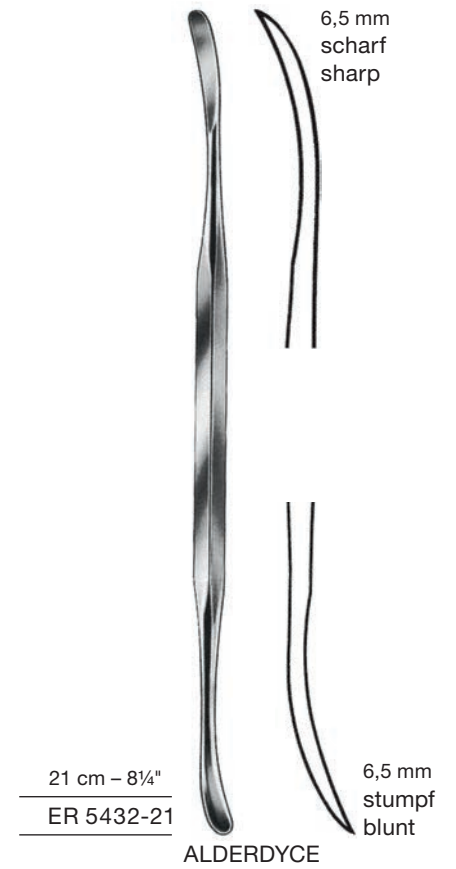
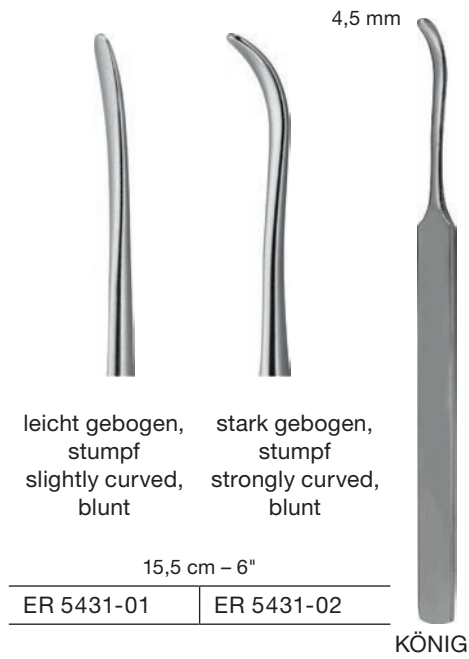

|  |            |
|--|------------|
| Fig. 1 – DBL. END.<br>17,5 cm – 7"     | ER 6350-01 |
| Fig. 2 – DBL. END.<br>19,5 cm – 7 3/4" | ER 6350-02 |
| Fig. 3 – DBL. END.<br>19,5 cm – 7 3/4" | ER 6350-03 |
| Fig. 4<br>20,5 cm – 8"                 | ER 6350-04 |
| Fig. 5 – DBL. END.<br>29 cm – 11 1/2"  | ER 6350-05 |





## Knochenhebel Bone Levers



MINI-HOHMANN





HOHMANN

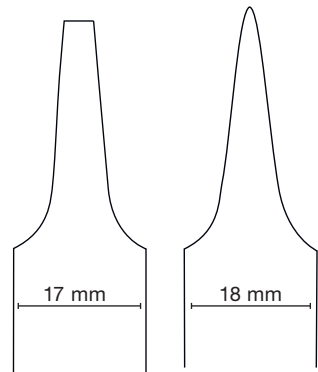

ER 5442-17 | ER 5442-18

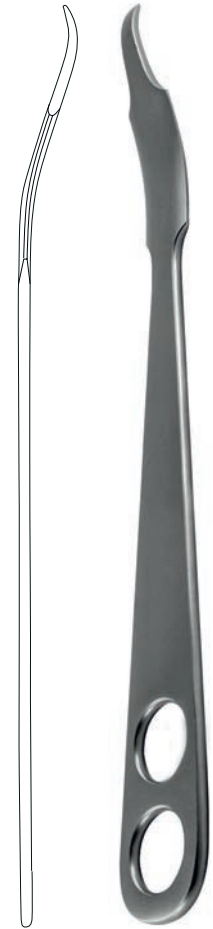

HOHMANN



HOHMANN 1:3



HOHMANN 1:3



VERBRUGGE-MÜLLER 1:3



HOHMANN



HOHMANN



HOHMANN-ALDINGER



LANE-TRETHOWAN





7 mm

16 cm – 6¼"  
ER 4546-17

BLOUNT



1:3

33 cm – 13"  
ER 5445-32

MURPHY-LANE



26 cm – 10¼"  
ER 5447-01

BLOUNT



47 mm

26 cm – 10¼"  
ER 5447-02

BLOUNT 1:3



24 cm – 9½"  
44 mm ER 5450-44  
60 mm ER 5450-64

BENNETT 1:3



## Knochenhaken Bone Retractors



VOLKMANN



VOLKMANN

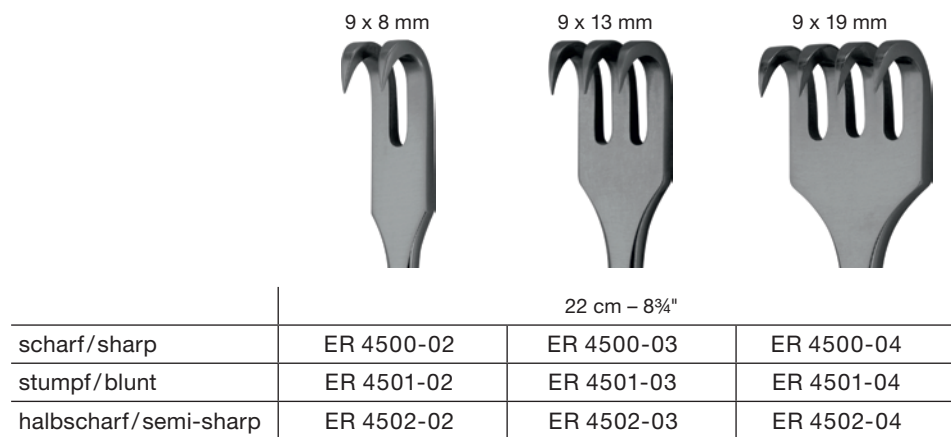



KOCHER



KOCHER



KOCHER



KOCHER



KOCHER

15 x 10 mm



15 x 15 mm



15 x 20 mm



15 x 30 mm



15 x 40 mm



22,5 cm – 8¾"

|                          |            |            |            |            |            |
|--------------------------|------------|------------|------------|------------|------------|
| scharf<br>sharp          | ER 4506-02 | ER 4506-03 | ER 4506-04 | ER 4506-06 | ER 4506-08 |
| stumpf<br>blunt          | ER 4507-02 | ER 4507-03 | ER 4507-04 | ER 4507-06 | ER 4507-08 |
| halbscharf<br>semi-sharp | ER 4508-02 | ER 4508-03 | ER 4508-04 | ER 4508-06 | ER 4508-08 |



KOCHER

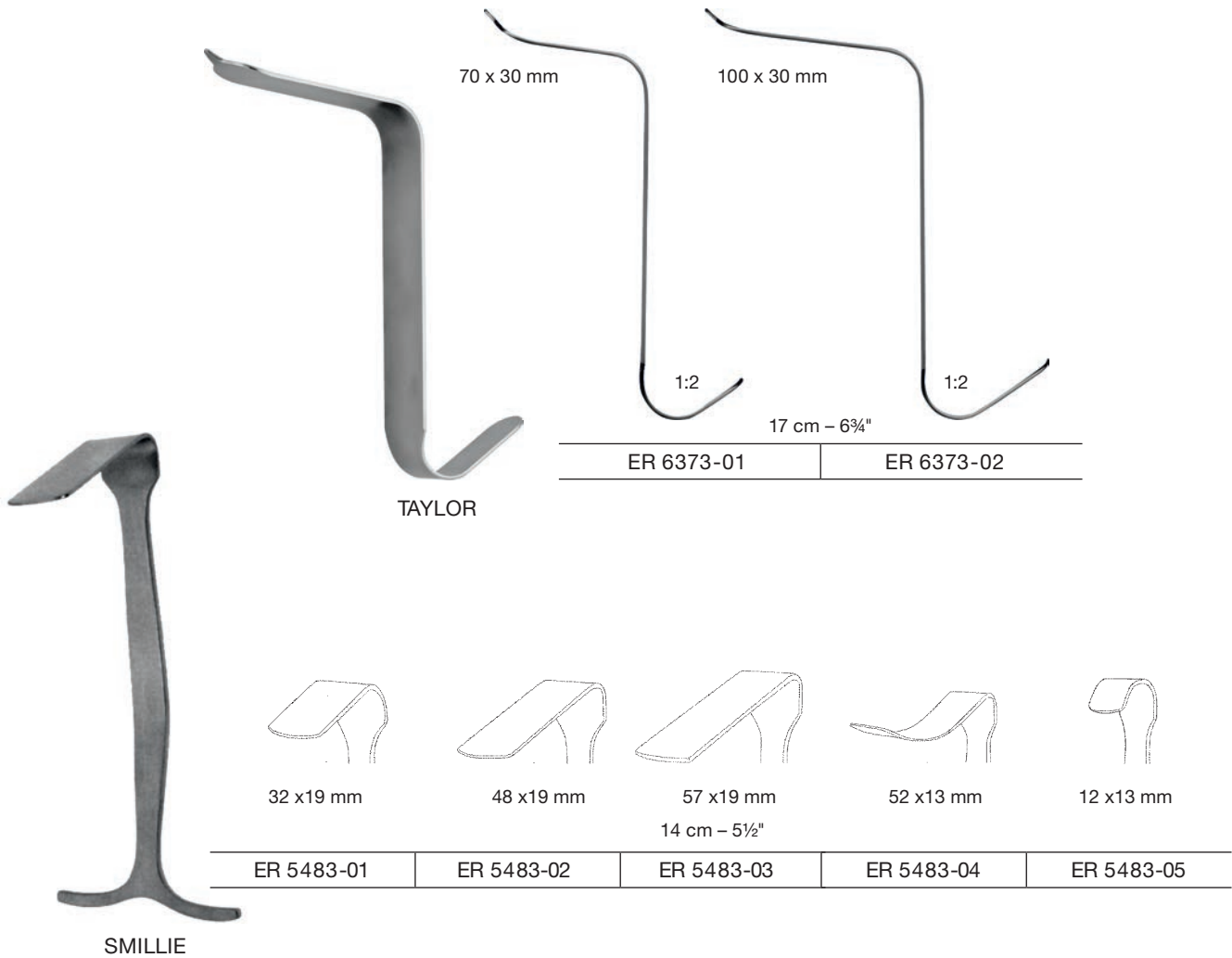

TAYLOR

SMILLIE



7 mm

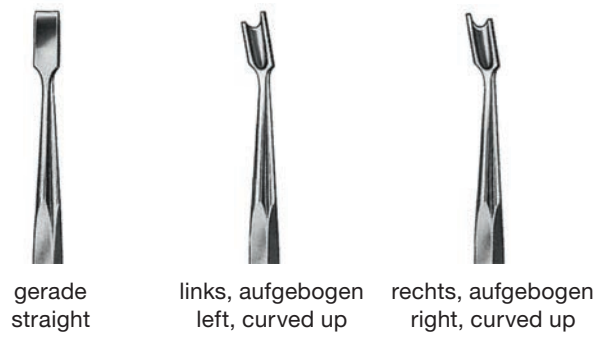

gerade straight      links, aufgebogen left, curved up      rechts, aufgebogen right, curved up

17 cm - 6 3/4"

|            |            |            |
|------------|------------|------------|
| ER 5480-17 | ER 5481-17 | ER 5482-17 |
|------------|------------|------------|

SMILLIE



Sequesterzange  
Sequestrum forceps



gerade  
straight

aufgebogen  
curved up

20 cm – 8"

ER 5500-20

ER 5501-20



19 cm – 7½"

ER 5505-19



DINGMANN



19 cm – 7½"

ER 5506-19



DINGMANN (modif.)



19 cm – 7½"

ER 5508-19



MARTIN



## Knochenhaltezaugen Bone Holding Forceps



BIRCHER-GANSKE



gerade  
straight



aufgebogen  
curved up



seitlich gebogen  
curved to side

20 cm – 8"

|            |            |            |
|------------|------------|------------|
| ER 5510-00 | ER 5510-20 | ER 5511-20 |
|------------|------------|------------|



LEWIN

17,5 cm – 7"

ER 5512-17



LANGENBECK

21 cm – 8¼"

ER 5514-21





11 mm

21 cm – 8¼"  
ER 5516-21

FERGUSSON



16 cm – 6¼" | ER 5518-16  
24 cm – 9½" | ER 5518-24



|             | ohne Sperre<br>without ratchet | mit Sperre<br>with ratchet |
|-------------|--------------------------------|----------------------------|
| 17 cm – 6¾" | ER 5520-17                     | ER 5521-17                 |
| 21 cm – 8¼" | ER 5520-21                     | ER 5521-21                 |

KERN





**Knochenhaltezangen**  
**Bone Holding Forceps**



19 cm – 7½"  
ER 5525-19

SEMBO



19 cm – 7½"  
ER 5525-51

SEMBO



VERBRUGGE



VERBRUGGE



mit Lappenverschluss  
with lip joint

|                           |                            |                            |
|---------------------------|----------------------------|----------------------------|
| 25 cm – 10"<br>ER 5527-25 | 26 cm – 10¼"<br>ER 5527-26 | 27 cm – 10½"<br>ER 5527-27 |
|---------------------------|----------------------------|----------------------------|



|              |            |
|--------------|------------|
| 15 cm – 6"   | ER 5528-15 |
| 19 cm – 7½"  | ER 5528-19 |
| 24 cm – 9½"  | ER 5528-24 |
| 26 cm – 10¼" | ER 5528-26 |
| 28 cm – 11"  | ER 5528-28 |

Amputationsretraktor,  
Griffe abnehmbar  
Amputation retractor,  
removeable handles

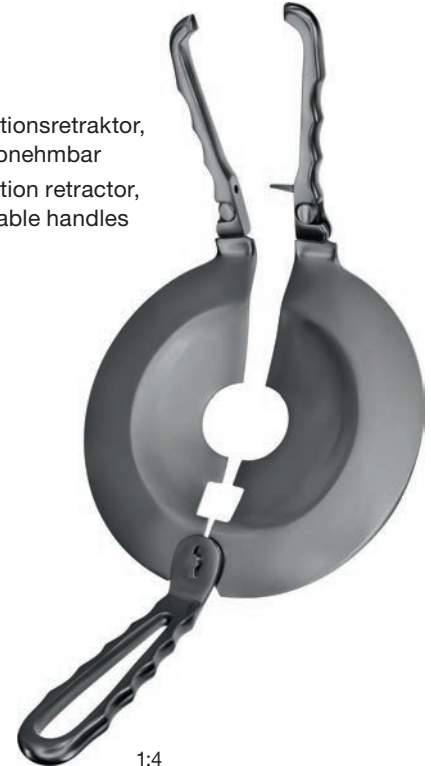

PERCY  
ER 5529-30

1:4

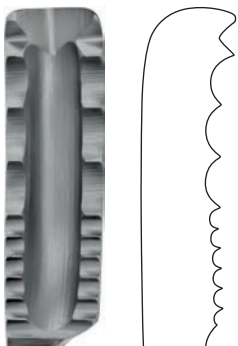

26 cm – 10¼"  
ER 5533-26



FARABEU-F-LAMBOTTE

|              |            |
|--------------|------------|
| 19 cm – 7½"  | ER 5535-19 |
| 23 cm – 9"   | ER 5535-23 |
| 26 cm – 10¼" | ER 5535-26 |



LAMBOTTE



## Knochenhaltezangen Bone Holding Forceps



LANE

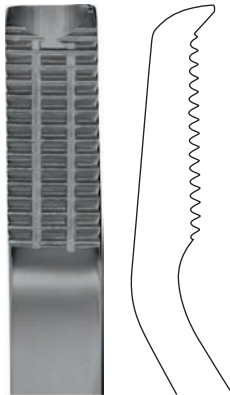

mit Sperre  
with ratchet

|             |            |
|-------------|------------|
| 33 cm – 13" | ER 5536-33 |
| 43 cm – 17" | ER 5536-45 |



14,5 cm – 5¾"  
ER 5537-14



13,5 cm – 5¼"  
ER 5538-12



13,5 cm – 5¼"  
ER 5539-13



17 cm – 6¾"  
ER 5540-17



20 cm – 8"  
ER 5539-20



18 cm – 7" | ER 5542-18  
20 cm – 8" | ER 5542-20  
22 cm – 8¾" | ER 5542-22

LOWMAN



13 cm – 5"  
ER 5543-12

MINI-LOWMAN

Patellazange  
Patella forceps



17,5 cm – 7"  
ER 5540-01



STELLBRINK

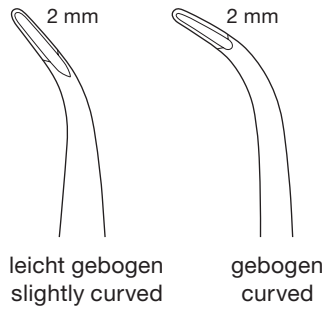

17 cm – 6¾"  
ER 5558-01 | ER 5558-02



BANE-HARTMANN



17,5 cm – 7"  
ER 5559-17



MINI-FRIEDMANN



12,5 cm – 5"  
ER 5560-12



LUER-FRIEDMANN



14 cm – 5½"  
ER 5560-14



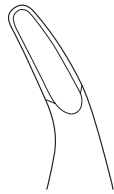

gebogen  
curved

18 cm – 7"

ER 5563-18



HARTMANN



gebogen  
curved

14 cm – 5½"

ER 5562-14

17 cm – 6¾"

ER 5562-17



CLEVELAND

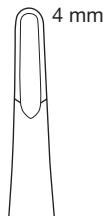

4 mm

gerade  
straight

17,5 cm – 7"

ER 5573-17



JANSEN

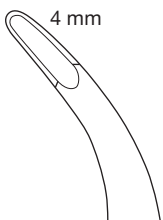

4 mm

gebogen  
curved

17,5 cm – 7"

ER 5574-17

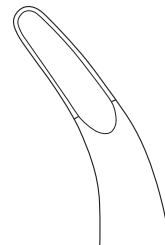

gebogen  
curved

20 cm – 8"

ER 5565-20



OLIVECRONA

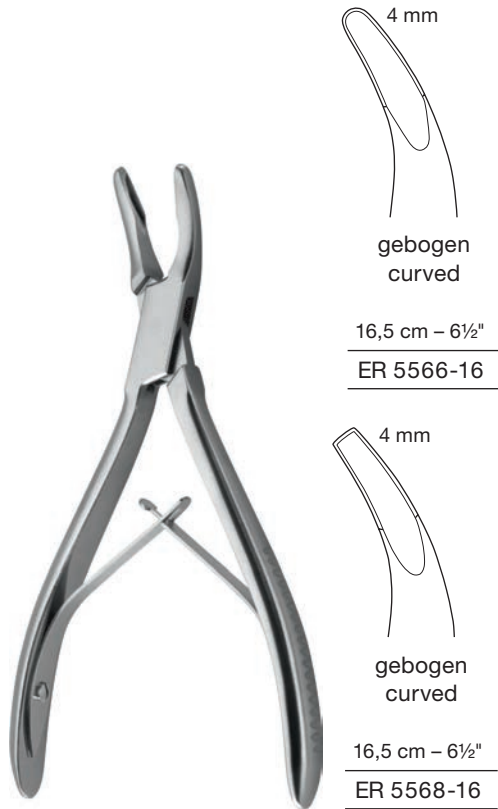

MEAD



LEMPERT



BLUMENTHAL



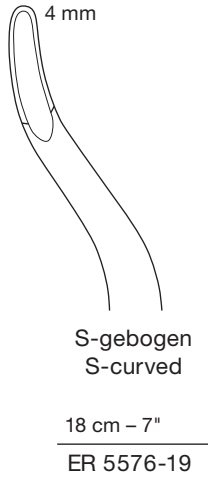

JANSEN

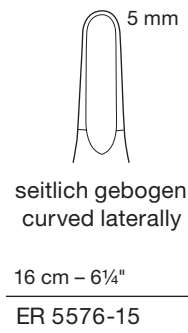

HAKANSSON

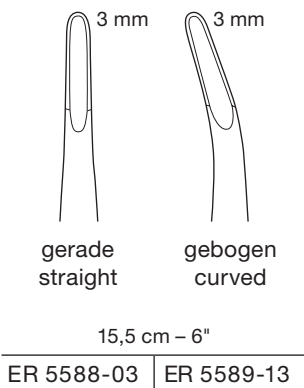

BÖHLER



LUER



ZAUFAL-JANSEN

4 mm

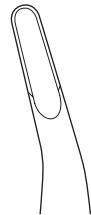

gebogen  
curved

18 cm – 7"

ER 5590-18



BEYER

3 mm

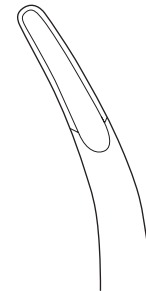

gebogen  
curved

18 cm – 7"

ER 5592-18



MAYFIELD

3 mm

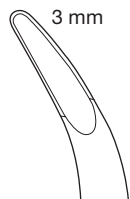

gebogen  
curved

17,5 cm – 7"

ER 5593-17



RUSKIN

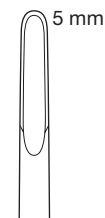

gerade  
straight

18 cm – 7"

ER 5594-24

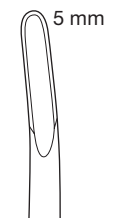

gebogen  
curved

ER 5594-34

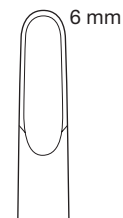

gerade  
straight

18 cm – 7"

ER 5594-51

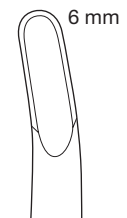

gebogen  
curved

23,5 cm – 9¼"

ER 5594-53

ER 5594-18  
ER 5594-23



gebogen  
curved

20 cm - 8"

ER 5595-20



MARQUARDT

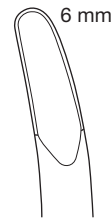

gebogen  
curved

24 cm - 9½"

ER 5596-24



RÖTTGEN-RUSKIN

2,0 mm

3,0 mm

4,0 mm



23 cm - 9"

ER 5605-02

ER 5605-03

ER 5605-04

6 mm

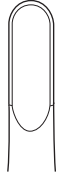

gebogen  
curved

23 cm - 9"

ER 5608-23



STILLE

1:3



ECHLIN

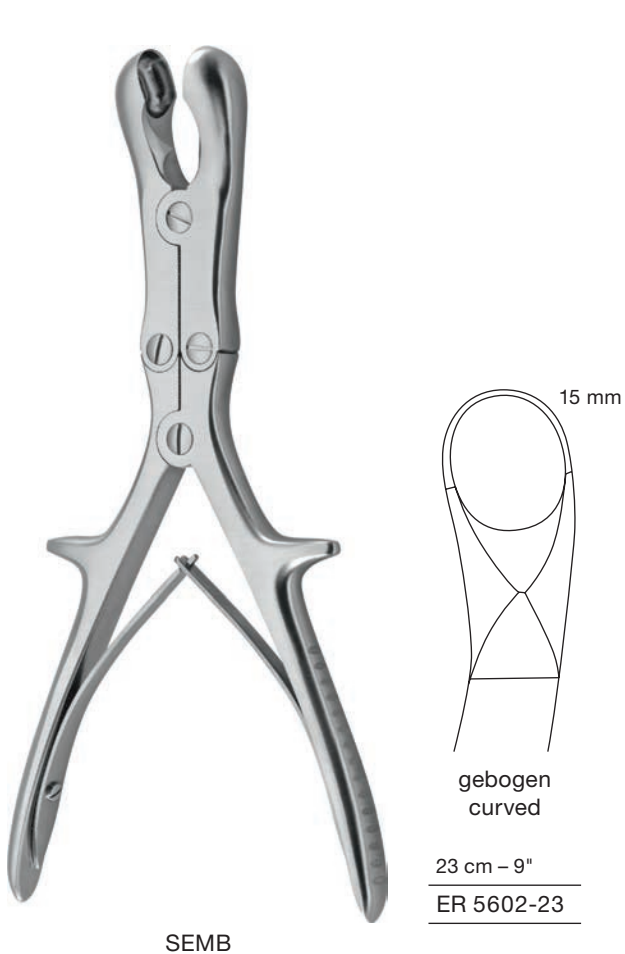
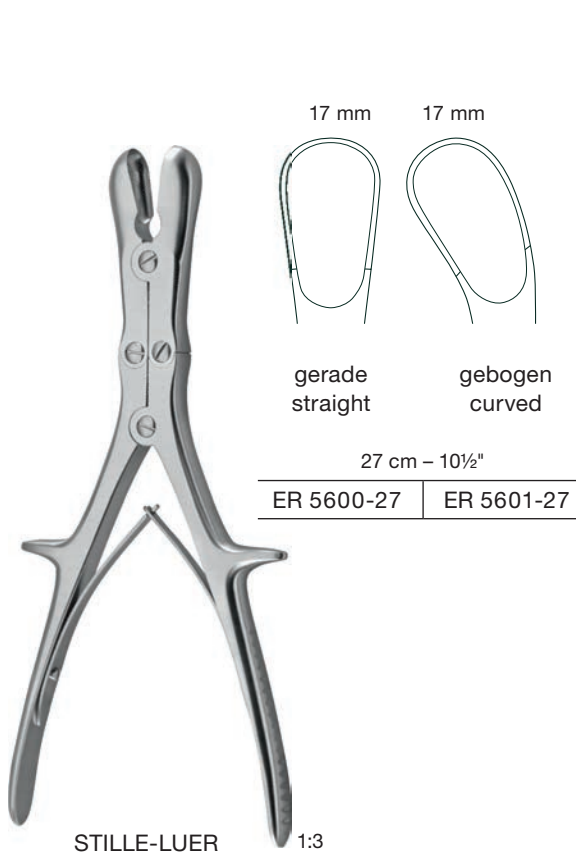

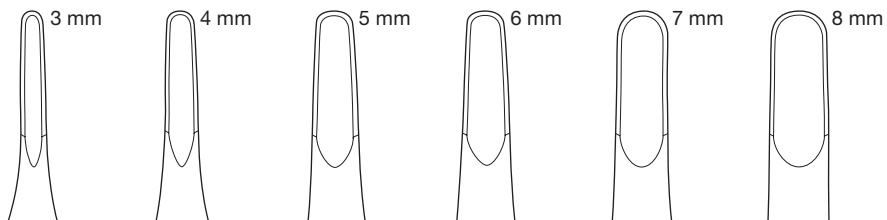

leicht gebogen  
slightly curved

23,5 cm – 9¼"

|            |            |            |            |            |            |
|------------|------------|------------|------------|------------|------------|
| ER 5606-03 | ER 5606-04 | ER 5606-05 | ER 5606-06 | ER 5606-07 | ER 5606-08 |
|------------|------------|------------|------------|------------|------------|



LEKSELL

1:3

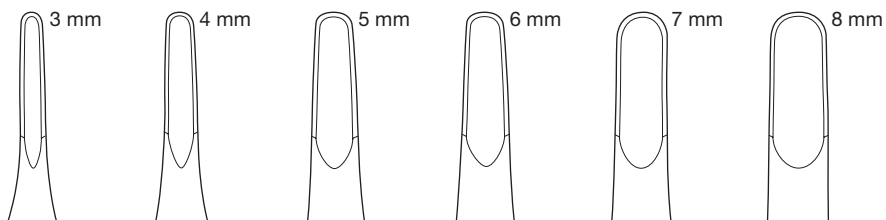

gebogen  
curved

24 cm – 9¾"

|            |            |            |            |            |            |
|------------|------------|------------|------------|------------|------------|
| ER 5606-13 | ER 5606-14 | ER 5606-15 | ER 5606-16 | ER 5606-17 | ER 5606-18 |
|------------|------------|------------|------------|------------|------------|



LEKSELL

1:3





## Knochensplitterzangen Bone Cutting Forceps



LISTON

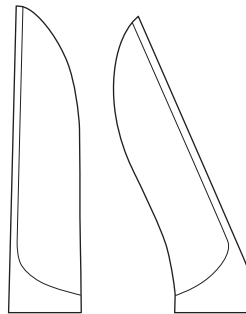

gerade  
straight

gebogen  
curved

|             |            |            |
|-------------|------------|------------|
| 14 cm – 5½" | ER 5640-14 | ER 5641-14 |
| 17 cm – 6¾" | ER 5640-17 | ER 5641-17 |
| 20 cm – 8"  | ER 5640-19 | ER 5641-19 |
| 22 cm – 8¾" | ER 5640-22 | ER 5641-22 |



MC INDOE

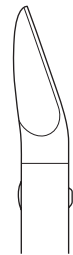

17,5 cm – 7"

ER 5702-17



BÖHLER



gerade  
straight

gebogen  
curved

15 cm – 6"

|            |            |
|------------|------------|
| ER 5700-15 | ER 5701-15 |
|------------|------------|



18 cm – 7"

ER 8125-18



KAZANJIAN



gerade  
straight



gebogen  
curved

18,5 cm – 7¼"

ER 5710-18

ER 5711-18



RUSKIN-LISTON

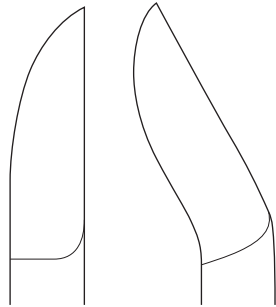

23 cm – 9"

ER 5716-23

ER 5717-23

27 cm – 10½"

ER 5716-27

ER 5717-27



STILLE-LISTON

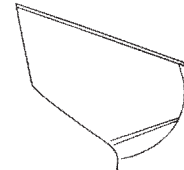

27 cm – 10½"

ER 5718-27



S-gebogen  
S-curved

LISTON-KEY-HORSLEY

1:3





Nagelspaltzange  
Nail nipper

13,5 cm – 5¼"

ER 5722-13



Rundzange  
Round pliers

18 cm – 7"

ER 5723-04



Flachzange  
Flat nose pliers



18 cm – 7"

ER 5724-18



Nagelausreißzange  
Nail pulling forceps



13,5 cm – 5¼"

ER 5726-13

RADOLF



Sägeblatt, allein,  
für Hartmetall nicht geeignet  
Saw blade, only,  
not suitable for carbide metal

---

ER 5728-21



Fingerringsäge,  
kompl. mit 1 Sägeblatt  
Finger ring saw,  
compl. with 1 saw blade

---

15 cm – 6"

---

ER 5728-17

Sägeblatt, allein  
Saw blade, only

---

ER 5732-99



23 cm – 9"

---

ER 5730-23

1:3  
LANGENBECK



31 cm – 12¼"

---

ER 5732-31

1:3  
SATTERLEE



Sägeblatt, allein  
Saw blade, only

ER 5735-99

27 cm – 10½"

ER 5735-27



CHARRIÈRE

Säge komplett, bestehend aus:  
Saw complete, consisting of:

ER 5736-35

- 1 Säge 35 cm – 13¾"
- 1 Saw 35 cm – 13¾"
- 1 Sägeblatt 12 mm (ER 5736-42)
- 1 Saw blade 12 mm (ER 5736-42)
- 1 Sägeblatt 18 mm (ER 5736-45)
- 1 Saw blade 18 mm (ER 5736-45)

| Blattbreite<br>Blade width | Sägeblätter<br>Saw blades |
|----------------------------|---------------------------|
| 12 mm                      | ER 5736-42                |
| 18 mm                      | ER 5736-45                |



#### HUDSON

Bohrapparat komplett, bestehend aus:  
Hand drill complete, consisting of: ER 5744-00

Griff, allein (ER 5744-10)  
Handle, only (ER 5744-10)

Fräser Fig. 1 (ER 5744-01)  
Cutter Fig. 1 (ER 5744-01)

Fräser Fig. 2 (ER 5744-02)  
Cutter Fig. 2 (ER 5744-02)

Fräser Fig. 3 (ER 5744-03)  
Cutter Fig. 3 (ER 5744-03)

Fräser Fig. 4 (ER 5744-04)  
Cutter Fig. 4 (ER 5744-04)

Verlängerungsstück Fig. 9 (ER 5744-09)  
Extension piece Fig. 9 (ER 5744-09)



HUDSON

CUSHING

MC KENZIL

ERRICO

|            |            |            |            |            |            |            |            |
|------------|------------|------------|------------|------------|------------|------------|------------|
| Fig. 1     | Fig. 2     | Fig. 3     | Fig. 4     | Fig. 5     |            |            |            |
| Ø 9 mm     | Ø 14 mm    | Ø 16 mm    | Ø 22 mm    | Ø 14 mm    | Ø 2 mm     | Ø 13 mm    | Ø 16 mm    |
| ER 5744-01 | ER 5744-02 | ER 5744-03 | ER 5744-04 | ER 5744-05 | ER 5744-06 | ER 5744-07 | ER 5744-08 |



### STILLE

|   |            |
|---|------------|
| Bohrapparat komplett, bestehend aus:<br>Hand drill complete, consisting of: | ER 5746-00 |
|---|------------|

Griff, allein 24 cm – 9½" (ER 5746-10)  
Handle, only 24 cm – 9½" (ER 5746-10)

Bohrer Fig. 1 (ER 5746-01)  
Drill Fig. 1 (ER 5746-01)

Bohrer Fig. 2 (ER 5746-02)  
Drill Fig. 2 (ER 5746-02)

Bohrer Fig. 3 (ER 5746-03)  
Drill Fig. 3 (ER 5746-03)

Bohrer Fig. 4 (ER 5746-04)  
Drill Fig. 4 (ER 5746-04)

Bohrer Fig. 5 (ER 5746-05)  
Drill Fig. 5 (ER 5746-05)

Fräser Fig. 6 (ER 5746-06)  
Cutter Fig. 6 (ER 5746-06)

Fräser Fig. 7 (ER 5746-07)  
Cutter Fig. 7 (ER 5746-07)

Fräser Fig. 8 (ER 5746-08)  
Cutter Fig. 8 (ER 5746-08)

Fräser Fig. 9 (ER 5746-09)  
Cutter Fig. 9 (ER 5746-09)

Griff, allein  
Handle, only

|             |
|-------------|
| 24 cm – 9½" |
| ER 5746-10  |



|            |            |            |            |            |            |            |            |             |
|------------|------------|------------|------------|------------|------------|------------|------------|-------------|
| Fig. 1     | Fig. 2     | Fig. 3     | Fig. 4     | Fig. 5     | Fig. 6     | Fig. 7     | Fig. 8     | Fig. 9      |
| Ø 2,5 mm   | Ø 3 mm     | Ø 3,5 mm   | Ø 4 mm     | Ø 10 mm    | Ø 5 mm     | Ø 8 mm     | Ø 12 mm    | Ø 16 mm     |
| ER 5746-01 | ER 5746-02 | ER 5746-03 | ER 5746-04 | ER 5746-05 | ER 5746-06 | ER 5746-07 | ER 5746-08 | ER 5746 -09 |



ER 57 50-02



ER 5750-01

Handbohrapparat mit Dreibacken-Spannfutter und Spannschlüssel (ER5750-02).  
Spannweite bis  $\varnothing 6,35$  mm, längsdurchbohrt, zur Aufnahme von Bohrdrähten und Nägeln.  
Hand drill with three-jaw chuck and key (ER5750-02), for shanks up to 6.35 mm diam.,  
cannulated, for taking wire drills and nails.



Handgriff mit Jacobs-Spannfutter  
0,5 - 7 mm und Spannschlüssel, allein  
Handle with Jacobs chuck 0.5 - 7 mm  
and wrench, only

ER 5747-01



Spannschlüssel, allein  
Wrench, only

ER 5747-11



14 cm - 5½"  
ER 5749-06



21 cm - 8¼"  
ER 5749-11

PERTHES





Körnung 0,5 mm  
Grit 2500 tpsi



16 cm – 6¼"  
ER 5760-16

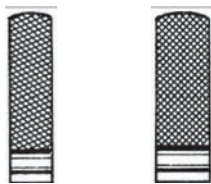

|            |            |            |
|------------|------------|------------|
| Typ / Type | 18 cm – 7" |            |
| TC         | ER 5723-18 | ER 5724-18 |

Körnung 0,5 mm  
Grit 2500 tpsi



|            |            |
|------------|------------|
| Typ / Type | 18 cm – 7" |
| TC         | ER 5761-08 |



## Drahtspannzangen Wire Twisting Forceps



Körnung 0,5 mm  
Grit 2500 tpsi



|            |            |            |
|------------|------------|------------|
| Typ / Type | 15 cm – 6" | 15 cm – 6" |
| TC         | ER 5761-10 | ER 5761-12 |

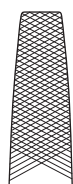

17 cm – 6¾"

|            |            |
|------------|------------|
| ER 5761-31 | ER 5761-32 |
|------------|------------|

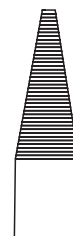
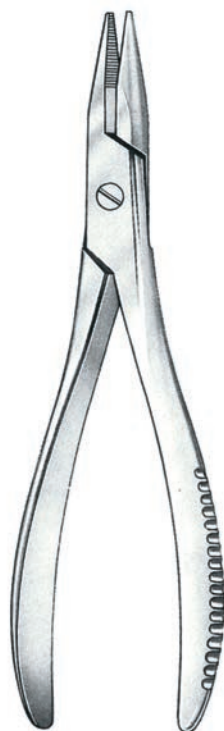

19 cm – 7½"

|            |
|------------|
| ER 5761-33 |
|------------|



18 cm – 7"  
ER 5764-60

rostfreier Stahl  
stainless steel



18 cm – 7"  
ER 5764-51



rostfreier Stahl  
stainless steel

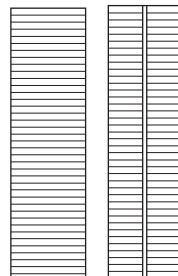

18,5 cm – 7¼"  
ER 5764-00





## Drahtschneidezangen Wire Cutting Pliers

für weichen Knochendraht  
für harte Bohrdrähte/Knochnägeln  
for soft bone wire  
for hard drill wires/bone nails



|               |          |
|---------------|----------|
| weich<br>soft | Ø 2 mm   |
| hart<br>hard  | Ø 1,5 mm |

|            |            |
|------------|------------|
| Typ / Type | 15 cm – 6" |
| TC         | ER 5762-15 |



|               |          |
|---------------|----------|
| weich<br>soft | Ø 1,7 mm |
|---------------|----------|

Drahtschneider durchbohrt  
Cannulated wire cutter

|               |
|---------------|
| 18,5 cm – 7¼" |
| ER 5762-18    |



|               |        |
|---------------|--------|
| weich<br>soft | Ø 2 mm |
| hart<br>hard  | Ø 2 mm |

|             |
|-------------|
| 16 cm – 6¼" |
| ER 5762-50  |



für weichen Knochen Draht  
für harte Bohrdrähte/Knochnägel  
for soft bone wire  
for hard drill wires/bone nails

|      |          |
|------|----------|
| hart | Ø 0,6 mm |
| hard |          |



|            |             |
|------------|-------------|
| Typ / Type | 12 cm - 4¾" |
| TC         | ER 5766-12  |



mit Silikoneinlage im Maul  
with Silicone inserts

|       |          |
|-------|----------|
| weich | Ø 2 mm   |
| soft  |          |
| hart  | Ø 1,7 mm |
| hard  |          |

|            |            |
|------------|------------|
| Typ / Type | 18 cm - 7" |
| TC         | ER 5767-18 |





## Drahtschneidezangen Wire Cutting Pliers

für weichen Knochendraht  
für harte Bohrdrähte/Knochnägel  
for soft bone wire  
for hard drill wires/bone nails



|               |          |
|---------------|----------|
| weich<br>soft | Ø 3,5 mm |
| hart<br>hard  | Ø 3,5 mm |

23 cm – 9"  
ER 5765-24



|               |             |
|---------------|-------------|
| Typ / Type    | 22 cm – 8¾" |
| TC            | ER 5769-22  |
| weich<br>soft | Ø 3 mm      |
| hart<br>hard  | Ø 2,5 mm    |

|               |            |
|---------------|------------|
| Typ / Type    | 18 cm – 7" |
| TC            | ER 5769-18 |
| weich<br>soft | Ø 2 mm     |
| hart<br>hard  | Ø 1,7 mm   |



|               |            |
|---------------|------------|
| 47 cm – 18½"  | ER 5767-47 |
| 57 cm – 22,5" | ER 5767-57 |

Bolzenschneider zum Abwickeln  
von Drähten, Schrauben und  
Nägeln bis zu Ø 6 mm

Cutter for cutting off wires,  
bolts and pins up to Ø 6 mm

mit abnehmbaren Griffen  
with removable handles





## Extensionsbügel Extension Bows

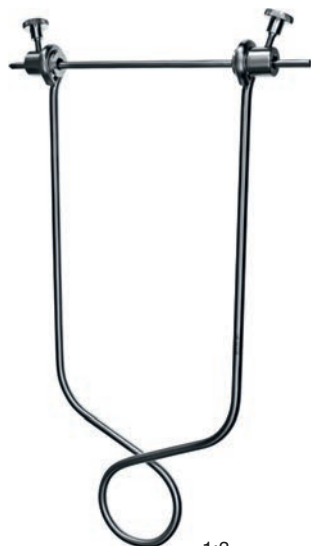

1:3

BÖHLER

mit 1 Nagel  
with 1 pin

für Arm  
for arm

|                       |            |
|-----------------------|------------|
| 16 x 9 cm – 6¼" x 3½" | ER 5770-16 |
|-----------------------|------------|

für Oberschenkel und Knie  
for thigh and knee

|                        |            |
|------------------------|------------|
| 21 x 11 cm – 8¼" x 4¼" | ER 5770-21 |
|------------------------|------------|



95 x 70 cm  
für Kinder  
for children

ER 5772-01

105 x 105 cm  
für Hand- und Fußgelenk  
for wrist and ankle

ER 5772-02

120 x 120 cm  
für Ellenbogen  
for elbow

ER 5772-03

155 x 155 cm  
für Knie  
for knee

ER 5772-04

200 x 155 cm  
für Oberschenkel  
for femur

ER 5772-05



lichte Weite  
clear width

|                      |            |
|----------------------|------------|
| 18 x 10 cm – 7" x 4" | ER 5773-18 |
|----------------------|------------|

|                         |            |
|-------------------------|------------|
| 27 x 16 cm – 10½" x 6¼" | ER 5773-27 |
|-------------------------|------------|



Knochendraht  
in Ringen zu 10 m  
Bone wire  
coil of 10 m

| Ø mm | weich<br>soft |
|------|---------------|
| 0,2  | ER 5778-02    |
| 0,3  | ER 5778-03    |
| 0,4  | ER 5778-04    |
| 0,5  | ER 5778-05    |
| 0,6  | ER 5778-06    |
| 0,7  | ER 5778-07    |
| 0,8  | ER 5778-08    |
| 0,9  | ER 5778-09    |
| 1,0  | ER 5778-10    |
| 1,2  | ER 5778-12    |
| 1,5  | ER 5778-15    |



Drahtspanninstrument  
Bone wire tighteners

21 cm – 8¼"  
ER 5782-00



LOUTE

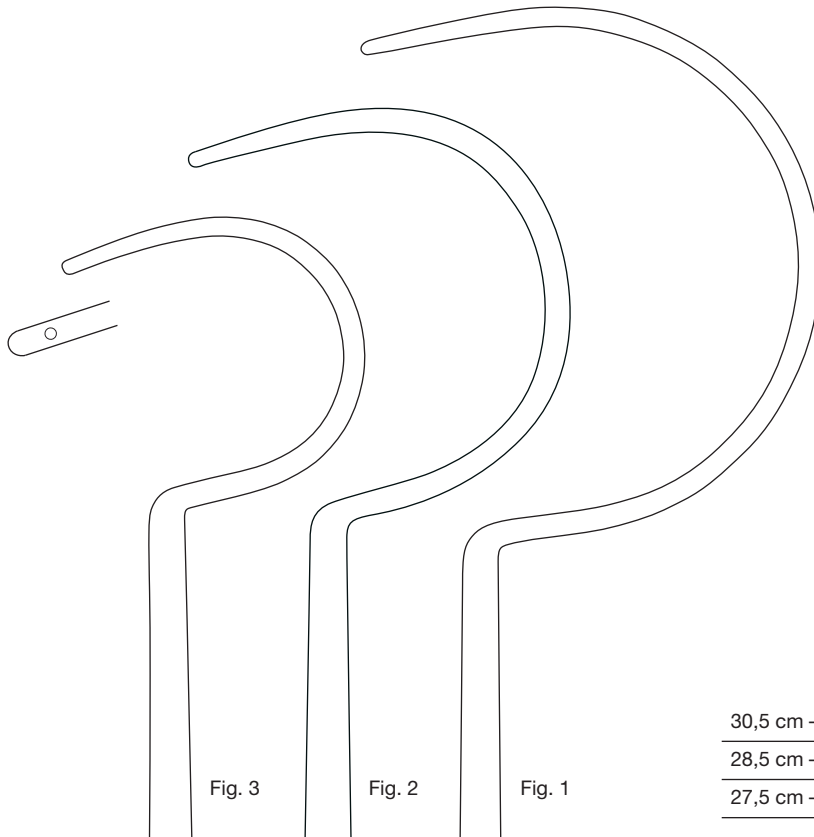

Drahtumföhrungsnadeln  
Bone wire guides

|                |        |            |
|----------------|--------|------------|
| 30,5 cm – 12"  | Fig. 1 | ER 5780-01 |
| 28,5 cm – 11¼" | Fig. 2 | ER 5780-02 |
| 27,5 cm – 10¾" | Fig. 3 | ER 5780-03 |



1:3  
DEMEL



Hämmer  
Mallets



Ø 45 mm  
380 g

24 cm – 9½"  
ER 5802-24

1:3  
BERGMANN



Ø 25 mm  
135 g

mit auswechselbaren  
Kunststoffbacken  
with interchangeable  
plastic disks

Ersatzbackenpaar  
Pair of spare disks

ER 5799-51

19 cm – 7½"  
ER 5799-18



Ø 30 mm  
245 g

23,5 cm – 9¼"  
ER 5800-23

1:3  
BERGMANN



Ø 40 mm  
550 g

24 cm – 9½"  
ER 5806-24

1:3  
OMBREDANNE



Ø 40 mm  
700 g

18 cm – 7"  
ER 5805-18

HEATH



Ø 30 / 42 mm  
400 g

24 cm – 9½"  
ER 5804-24

1:3



Ø 35 mm  
100 g

26 cm – 10¼"

ER 5808-01

Ø 43 mm  
170 g

26 cm – 10¼"

ER 5808-02

Ø 50 mm  
220 g

26 cm – 10¼"

ER 5808-03



1:3

Ø 30 mm  
235 g

konvex / flach  
convex / flat

19 cm – 7½"

ER 5809-19



COTTLE

Ø 27 mm  
135 g



HAJEK

23 cm – 9"

ER 5811-23

Ø 19 mm  
80 g

19 cm – 7½"

ER 5813-01

Ø 25 mm  
140 g

19 cm – 7½"

ER 5813-02

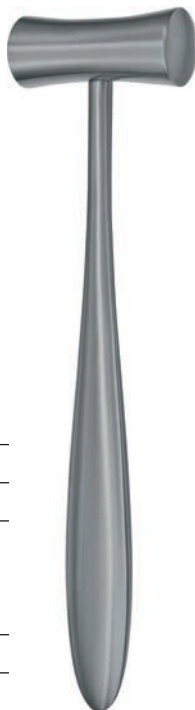

LUCAE

Ø 20 mm  
100 g

bleigefüllt  
lead filled

16,5 cm – 6½"

ER 5814-16

Ø 20 mm  
75 g

Messing  
Brass

16,5 cm – 6½"

ER 5815-16



Ø 26 mm  
170 g

mit auswechselbaren  
Kunststoffbacken  
with interchangeable  
plastic disks

Ersatzbackenpaar  
Pair of spare disks

ER 5816-20

17 cm – 6¾"

ER 5816-17



MEAD

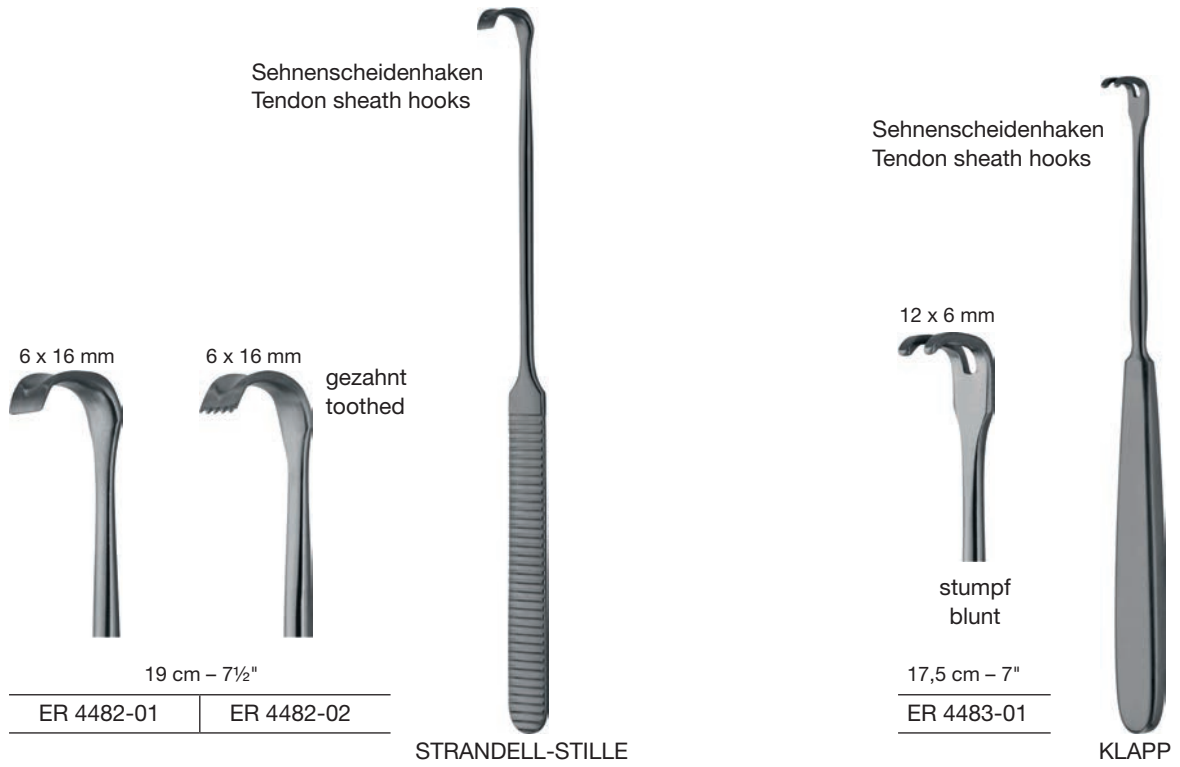



Sehnedurchziehzange  
Tendon passing forceps



leicht gebogen  
slightly curved

20 cm – 8"

ER 5827-35



KLEINERT-KUTZ

Sehnenflechklemme  
Tendon plating forceps



gerade  
straight

ER 5827-20



gebogen  
curved

ER 5827-21



Sehnenfasszange  
Tendon seizing forceps

gerade  
straight

15 cm – 6"

ER 3160-15

19 cm – 7½"

ER 3160-19

24 cm – 9½"

ER 3160-24

gebogen  
curved

ER 3161-15

ER 3161-19

ER 3161-24



BRAND



## Hygiene und Aufbewahrung *Hygiene and Storage*

**Sterilisierzangen** / *Sterilization Forceps*

**Dreieckschalen und Stechbecken** / *Triangular Basins and Bed Pans*

**Messbecher und Nierenschalen** / *Measuring Jugs and Kidney Bowls*

**Runde Behälter** / *Round Basins*

**Instrumentenschalen** / *Instrument Trays*







Abfallzange  
Waste forceps



55 cm – 21¾"  
ER 8941-55

SAUERBRUCH 1:5

20 cm – 8"  
ER 8945-20

30 cm – 11¾"  
ER 8945-30



27 cm – 10½"  
ER 8947-27



CHEATLE 1:3

Sterilisierklammern  
Sterilization clamps

BUNT  
10,5 cm – 4¼"  
ER 8950-01



MAYO  
14 cm – 5½"  
ER 8950-02



MAYO  
14 cm – 5½"  
ER 8950-03



20 cm – 8"  
ER 8948-20



UNIVERSAL



|        | Messbecher<br>Measuring jugs |
|--------|------------------------------|
| 0,25 l | ER 8964-02                   |
| 0,50 l | ER 8964-05                   |
| 1,00 l | ER 8964-10                   |
| 1,50 l | ER 8964-15                   |
| 2,00 l | ER 8964-20                   |



|        |             | Nierenschalen<br>Kidney bowls |
|--------|-------------|-------------------------------|
| 0,25 l | 170 x 36 mm | ER 8970-01                    |
| 0,50 l | 250 x 32 mm | ER 8970-02                    |
| 0,75 l | 275 x 45 mm | ER 8970-03                    |



| Ø x H<br>Ø x h | Liter<br>Litre | Schalen<br>Trays |
|----------------|----------------|------------------|
| 150 x 74 mm    | 0,75 l         | ER 8988-01       |
| 160 x 65 mm    | 1,00 l         | ER 8988-02       |
| 220 x 70 mm    | 2,00 l         | ER 8988-03       |
| 230 x 80 mm    | 2,50 l         | ER 8988-04       |
| 260 x 130 mm   | 4,50 l         | ER 8988-05       |
| 275 x 115 mm   | 5,00 l         | ER 8988-06       |
| 300 x 105 mm   | 6,00 l         | ER 8988-07       |
| 400 x 150 mm   | 14,00 l        | ER 8988-09       |



|       | Medizinbecher<br>Medicine cups |
|-------|--------------------------------|
| 25 cc | ER 8975-05                     |
| 50 cc | ER 8975-10                     |



| Ø x H<br>Ø x h | Liter<br>Litre | Schalen<br>Trays |
|----------------|----------------|------------------|
| 40 x 19 mm     | 0,50 l         | ER 8985-10       |
| 61 x 30 mm     | 0,07 l         | ER 8985-11       |
| 80 x 40 mm     | 0,14 l         | ER 8985-01       |
| 116 x 50 mm    | 0,35 l         | ER 8985-02       |
| 128 x 55 mm    | 0,45 l         | ER 8985-03       |
| 147 x 65 mm    | 0,70 l         | ER 8985-04       |
| 167 x 75 mm    | 1,10 l         | ER 8985-05       |
| 187 x 85 mm    | 1,60 l         | ER 8985-06       |



1:3

| Ø x H<br>Ø x h | Standgefäße<br>Jars |
|----------------|---------------------|
| 30 x 90 mm     | ER 8984-01          |
| 50 x 100 mm    | ER 8984-02          |
| 50 x 130 mm    | ER 8984-03          |
| 50 x 175 mm    | ER 8984-04          |
| 75 x 130 mm    | ER 8984-05          |
| 75 x 175 mm    | ER 8984-06          |
| 100 x 175 mm   | ER 8984-07          |



1:3



Instrumentenschalen  
Instrument Trays



| L x B x H<br>l x b x h | Schalen<br>Trays |
|------------------------|------------------|
| 200 x 150 x 25 mm      | ER 8978-01       |
| 300 x 220 x 30 mm      | ER 8978-02       |
| 350 x 220 x 40 mm      | ER 8978-03       |



| L x B x H<br>l x b x h | Instrumentenkasten<br>Instrument box |
|------------------------|--------------------------------------|
| 200 x 100 x 35 mm      | ER 8980-01                           |
| 200 x 100 x 60 mm      | ER 8980-02                           |
| 230 x 150 x 50 mm      | ER 8980-03                           |
| 260 x 150 x 50 mm      | ER 8980-04                           |



| Schalen<br>Trays  |
|-------------------|
| 220 x 170 x 50 mm |
| ER 8989-00        |



|   |               |  |
|---|---------------|--|
| <b>A</b>  |               |  |
| Abortuszangen .....                                   | 303-304       |  |
| <b>Adson</b>  |               |  |
| Arterienklemmen .....                                 | 121-122       |  |
| Atrauma Pinzetten .....                               | 86            |  |
| Feine anatomische Pinzetten .....                     | 78-83         |  |
| Feine chirurgische Pinzetten .....                    | 89-94         |  |
| Hohlmeißelzangen .....                                | 448-449       |  |
| Kanülen .....   | 198-199       |  |
| Mikro-Nahtpinzetten .....                             | 74            |  |
| Nadelhalter .....                                     | 212-224       |  |
| Raspatorien .....                                     | 319-324       |  |
| Wundspreizer .....                                    | 181-182       |  |
| <b>Adson-Brown</b>                                    |               |  |
| Hautpinzetten .....                                   | 98            |  |
| <b>Adson-Ewald</b>                                    |               |  |
| Feine chirurgische Pinzetten .....                    | 90            |  |
| <b>Adson-Graefe</b>                                   |               |  |
| Hautpinzetten .....                                   | 98            |  |
| <b>Adson Standard</b>                                 |               |  |
| Feine anatomische Pinzetten .....                     | 78            |  |
| <b>Alderdyce</b>                                      |               |  |
| Elevatorien .....                                     | 327           |  |
| <b>Alexander</b>                                      |               |  |
| Flachmeißel .....                                     | 307           |  |
| Hohlmeißel .....                                      | 307           |  |
| Raspatorien .....                                     | 320           |  |
| Uterus Biopsie Zangen .....                           | 293           |  |
| <b>Allen</b>  |               |  |
| Magenklemmen .....                                    | 245           |  |
| <b>Allis</b>  |               |  |
| Darm- und<br>Gewebefasszangen .....                   | 236-238       |  |
| <b>Allis-Adair</b>                                    |               |  |
| Darm- und Gewebefasszangen .....                      | 237           |  |
| <b>Allis-Atrauma</b>                                  |               |  |
| Darm- und Gewebefasszangen .....                      | 237           |  |
| <b>Alm</b>  |               |  |
| Wundspreizer .....                                    | 173           |  |
| Amniotom für die Amnionblase .....                    | 280           |  |
| Amputationsmesser .....                               | 4, 7          |  |
| Amputationsretraktor .....                            | 339           |  |
| Analspreizer .....                                    | 235, 251, 252 |  |
| Anastomosenklemmen .....                              | 322-324       |  |
| Anatomische<br>Mikro-Pinzetten .....                  | 71            |  |
| Anatomische Pinzetten .....                           | 71            |  |
| <b>Andrew-Pynchon</b>                                 |               |  |
| Kanülen .....   | 197           |  |
| Anuskope .....  | 327           |  |
| Arterienklemmen .....                                 | 138-158       |  |
| Atrauma Pinzetten .....                               | 117           |  |
| <b>Austin</b>   |               |  |
| Mikro-Nahtpinzetten .....                             | 73            |  |
| <b>Auvard</b>   |               |  |
| Scheidenspekula .....                                 | 276           |  |
| <b>B</b>  |               |  |
| <b>Babcock</b>  |               |  |
| Darm- und Gewebefasszangen .....                      | 237           |  |
| <b>Babcock-Atrauma</b>                                |               |  |
| Darm- und Gewebefasszangen .....                      | 239           |  |
| <b>Baby-Adson</b>                                     |               |  |
| Arterienklemmen .....                                 | 120           |  |
| <b>Baby-Allis</b> Darm- und<br>Gewebefasszangen ..... | 236           |  |
| <b>Baby-Balfour</b>                                   |               |  |
| Bauchdeckenhalter .....                               | 187           |  |
| <b>Baby-Collin</b>                                    |               |  |
| Bauchdeckenhalter .....                               | 183           |  |
| <b>Baby-Crile</b>                                     |               |  |
| Arterienklemmen .....                                 | 112           |  |
| <b>Baby-Doyen</b>                                     |               |  |
| Darmklemmen .....                                     | 241           |  |
| <b>Baby-Kocher</b>                                    |               |  |
| Darmklemmen .....                                     | 243           |  |
| <b>Baby-Lexer (Knapp)</b>                             |               |  |
| Face Lift und Nasenscheren .....                      | 39            |  |
| <b>Baby-Metzenbaum</b>                                |               |  |
| Präparierscheren .....                                | 34            |  |
| <b>Baby-Mikulicz</b>                                  |               |  |
| Peritoneumklemmen .....                               | 134           |  |
| <b>Baby-Mixer</b>                                     |               |  |
| Ligaturklemmen .....                                  | 129           |  |
| <b>Baby-Roux</b>                                      |               |  |
| Wundhaken .....                                       | 157           |  |
| <b>Baby-Senn-Mueller</b>                              |               |  |
| Wundhaken .....                                       | 157           |  |
| <b>Baby-Tischler</b>                                  |               |  |
| Biopsie Zangen .....                                  | 293           |  |
| <b>Backhaus</b>                                       |               |  |
| Tuchklemmen .....                                     | 137           |  |
| <b>Bainbridge</b>                                     |               |  |
| Arterienklemmen .....                                 | 120           |  |
| <b>Bakes</b>  |               |  |
| Gallengangdilatoren .....                             | 225           |  |
| <b>Balfour</b>  |               |  |
| Bauchdeckenhalter .....                               | 187-189       |  |
| <b>Balfour USA-Modell</b>                             |               |  |
| Bauchdeckenhalter .....                               | 189           |  |
| <b>Ballentine</b>                                     |               |  |
| Hysterektomieklammern .....                           | 189           |  |
| <b>Bane-Hartmann</b>                                  |               |  |
| Hohlmeißelzangen .....                                | 342           |  |
| <b>Barnes-Neville</b>                                 |               |  |
| Geburtszangen .....                                   | 302           |  |
| <b>Baron</b>  |               |  |
| Kanülen .....   | 198           |  |
| <b>Barr</b>   |               |  |
| Rektum-Spekula .....                                  | 250           |  |
| <b>Barraquer</b>                                      |               |  |
| Cilienpinzetten .....                                 | 103           |  |
| Mikro-Nadelhalter .....                               | 210-211       |  |
| <b>Barraquer-Troutman</b>                             |               |  |
| Mikro-Nadelhalter .....                               | 211           |  |
| <b>Barrett</b>  |               |  |
| Hakenzangen .....                                     | 279           |  |
| <b>Beacham</b>  |               |  |
| Amniotom .....  | 280           |  |
| <b>Beebee</b>   |               |  |
| Kronenscheren .....                                   | 61            |  |
| <b>Beer</b>   |               |  |
| Cilienpinzetten .....                                 | 103           |  |
| <b>Bengolea</b>                                       |               |  |
| Arterienklemmen .....                                 | 121           |  |
| <b>Bennett</b>  |               |  |
| Knochenhebel .....                                    | 331           |  |
| <b>Bergmann</b>                                       |               |  |
| Verbandscheren .....                                  | 66            |  |
| Hämmer .....  | 367           |  |
| Wundhäkchen .....                                     | 152           |  |
| <b>Bernhard</b>                                       |               |  |
| Tuchklemmen .....                                     | 136           |  |
| <b>Beyer</b>  |               |  |
| Hohlmeißelzangen .....                                | 346           |  |
| <b>Biemer</b>   |               |  |
| Venenscheren .....                                    | 16            |  |
| <b>Bircher-Ganske</b>                                 |               |  |
| Knochenhalte-zangen .....                             | 336           |  |
| <b>Birkett</b>  |               |  |
| Arterienklemmen .....                                 | 122           |  |
| <b>Blake</b>  |               |  |
| Callenkanal-Klemmzange .....                          | 254           |  |
| Uterusküretten .....                                  | 295           |  |
| <b>Blount</b>   |               |  |
| Knochenhebel .....                                    | 331           |  |
| <b>Blumenthal</b>                                     |               |  |
| Hohlmeißelzangen .....                                | 344           |  |
| <b>Böhler</b>   |               |  |
| Extensionsbügel .....                                 | 365           |  |
| Hohlmeißelzangen .....                                | 345           |  |
| <b>Bonney</b>   |               |  |
| Anatomische Pinzetten .....                           | 85            |  |
| Chirurgische Pinzetten .....                          | 97            |  |
| <b>Böttcher</b>                                       |               |  |
| Tonsillen-Scheren .....                               | 51            |  |
| <b>Boys-Allis</b>                                     |               |  |
| Darm- und Gewebefasszangen .....                      | 237           |  |
| <b>Bozemann</b>                                       |               |  |
| Nadelhalter .....                                     | 218           |  |
| Tupferzangen .....                                    | 141-142       |  |
| <b>Bozemann-Douglas</b>                               |               |  |
| Tupferzangen .....                                    | 142           |  |
| <b>Brand</b>  |               |  |
| Sehnenschnitzzangen .....                             | 370           |  |
| <b>Braun</b>  |               |  |
| Hakenzangen .....                                     | 279-280       |  |
| Uterus-Depressor .....                                | 278           |  |
| <b>Braun-Stadler</b>                                  |               |  |
| Damm-(Episiotomie-)<br>Scheren .....                  | 59            |  |
| <b>Breisky</b>  |               |  |
| Scheidenspekula .....                                 | 274           |  |
| <b>Brodie</b>   |               |  |
| Rektal-Hohlsonden .....                               | 202           |  |
| <b>Brophy</b>   |               |  |
| Feine anatomische Pinzetten .....                     | 82            |  |
| Feine chirurgische Pinzetten .....                    | 93            |  |
| <b>Brophy (Sullivan)</b>                              |               |  |
| Feine Chirurgische Scheren .....                      | 24            |  |
| <b>Brown</b>  |               |  |
| Hautpinzetten .....                                   | 98            |  |
| Nadelhalter .....                                     | 212           |  |
| <b>Brunner</b>  |               |  |
| Führungs-Hohlsonden .....                             | 228           |  |
| Rektum- Anastomosenklemmen .....                      | 248           |  |
| Wundhaken .....                                       | 167, 170      |  |
| <b>Brunner-Ferrozell</b>                              |               |  |
| Führungs-Hohlsonden .....                             | 228           |  |
| <b>Bruns</b>  |               |  |
| Scharfe Löffel .....                                  | 313-314       |  |
| Verbandscheren .....                                  | 66-67         |  |
| <b>Buie</b>   |               |  |
| Klemmzange .....                                      | 133           |  |
| <b>Bunt</b>   |               |  |
| Sterilisierklammern .....                             | 372           |  |
| <b>Busch</b>  |               |  |
| Nabelschnurscheren .....                              | 58            |  |
| <b>C</b>  |               |  |
| <b>Carrel</b>   |               |  |
| Arterienklemmen .....                                 | 117           |  |





|                                 |               |
|---------------------------------|---------------|
| <b>Caspar</b>                   |               |
| Wundhaken .....                 | 163           |
| <b>Castanares</b>               |               |
| Präparierscheren .....          | 41            |
| <b>Castroviejo</b>              |               |
| Hornhautscheren .....           | 14-15         |
| Mikro Federscheren .....        | 14            |
| Mikro-Nadelhalter .....         | 209-211       |
| Rasierklingenhalter .....       | 6             |
| <b>Castroviejo/Barraquer</b>    |               |
| Mikro-Nadelhalter .....         | 210           |
| <b>Castroviejo-Kalt</b>         |               |
| Mikro-Nadelhalter .....         | 211           |
| <b>Chaput</b>                   |               |
| Arterienklemmen .....           | 117           |
| <b>Charrière</b>                |               |
| Sägen .....                     | 354           |
| <b>Cheron</b>                   |               |
| Tupferzangen .....              | 141           |
| <b>Cleveland</b>                |               |
| Hohlmeißelzangen .....          | 343           |
| <b>Cloward</b>                  |               |
| Wundspreizer .....              | 176           |
| <b>Cobb</b>                     |               |
| Raspatorien .....               | 323-324       |
| <b>Coller-Crile</b>             |               |
| Arterienklemmen .....           | 113           |
| <b>Collin</b>                   |               |
| Bauchdeckenhalter .....         | 183-185       |
| Gewebefasszange .....           | 118           |
| Geburtshilfe .....              | 300           |
| Rippenscheren .....             | 70            |
| Scheidenspekula .....           | 264           |
| Schwammzangen .....             | 143           |
| Tupferzangen .....              | 141           |
| Uterusfazzzangen .....          | 284           |
| Wundhaken .....                 | 159           |
| <b>Collin-Duval</b>             |               |
| Darm- und Lungenpinzetten ..... | 99            |
| <b>Collin-Pozzi</b>             |               |
| Hakenzangen .....               | 279           |
| <b>Cone</b>                     |               |
| Wundspreizer .....              | 182           |
| <b>Cone (Adson-Baby)</b>        |               |
| Wundspreizer .....              | 179           |
| <b>Converse</b>                 |               |
| Nadelhalter .....               | 221           |
| <b>Cooper</b>                   |               |
| Unterbindungsadeln .....        | 227           |
| <b>Cottle</b>                   |               |
| Flachmeißel .....               | 308           |
| Hämmer .....                    | 368           |
| Hautpinzetten .....             | 44            |
| Nasenscheren .....              | 43            |
| Ohrpinzetten .....              | 87            |
| Raspatorien .....               | 321           |
| <b>Crile</b>                    |               |
| Arterienklemmen .....           | 112           |
| Feine Wundhäkchen .....         | 148           |
| Wundhaken .....                 | 155           |
| <b>Crile-Murray</b>             |               |
| Nadelhalter .....               | 214           |
| <b>Crile-Rankin</b>             |               |
| Arterienklemmen .....           | 112           |
| <b>Crile-Wood</b>               |               |
| Nadelhalter .....               | 214, 219, 220 |
| <b>Cusco</b>                    |               |
| Scheidenspekula .....           | 264-266       |

|                                    |          |
|------------------------------------|----------|
| <b>Cushing</b>                     |          |
| Feine anatomische Pinzetten .....  | 82       |
| Feine chirurgische Pinzetten ..... | 92       |
| Feine Wundhäkchen .....            | 148      |
| Raspatorien .....                  | 319      |
| Wundhaken .....                    | 154-156  |
| <b>Cushing-Taylor</b>              |          |
| Feine anatomische Pinzetten .....  | 81       |
| <b>Czerny</b>                      |          |
| Hakenzangen .....                  | 280      |
| Rektum-Spekula .....               | 249      |
| <b>D</b>                           |          |
| <b>Damm-(Episiotomie)</b>          |          |
| Scheren .....                      | 59       |
| <b>Dandy</b>                       |          |
| Arterienklemmen .....              | 119      |
| <b>Daubenspeck</b>                 |          |
| Scharfe Löffel .....               | 315      |
| <b>Davidson</b>                    |          |
| Wundhaken .....                    | 171      |
| <b>Dean</b>                        |          |
| Zahnfleischscheren .....           | 62       |
| <b>Deaver</b>                      |          |
| Chirurgische Scheren .....         | 26       |
| Wundhaken .....                    | 167-168  |
| <b>De Bakey</b>                    |          |
| Atrauma Pinzetten .....            | 86       |
| Gefäßscheren .....                 | 48       |
| Nadelhalter .....                  | 220      |
| <b>Demel</b>                       |          |
| Drahtumführungsadeln .....         | 366      |
| <b>Denis-Brown</b>                 |          |
| Bauchdeckenhalter .....            | 192      |
| <b>Derf</b>                        |          |
| Nadelhalter .....                  | 212, 217 |
| <b>Deschamps</b>                   |          |
| Unterbindungsadeln .....           | 226      |
| <b>Deschamps-Standard</b>          |          |
| Unterbindungsadeln .....           | 225      |
| <b>Desjardins</b>                  |          |
| Gallenkanal-Klemmzangen .....      | 254      |
| Gallensteinzangen .....            | 254      |
| <b>Desmarres</b>                   |          |
| Wundhaken .....                    | 155      |
| <b>Dieffenbach</b>                 |          |
| Bulldogklemmen .....               | 145      |
| <b>Diethrich</b>                   |          |
| Bulldogklemmen .....               | 146      |
| <b>Dingmann</b>                    |          |
| Knochenhalte-zangen .....          | 335      |
| <b>Dixon-Lovelace</b>              |          |
| Arterienklemmen .....              | 119      |
| <b>Douglas</b>                     |          |
| Cilienpinzetten .....              | 103      |
| <b>Doyle</b>                       |          |
| Bauchdeckenhalter .....            | 193      |
| Darmklemmen .....                  | 241      |
| Gynäkologische Scheren .....       | 57       |
| Myomheber .....                    | 285      |
| Raspatorien .....                  | 322      |
| Scheidenspekula .....              | 273-275  |
| Sonden .....                       | 201      |
| Wundhaken .....                    | 165      |
| <b>Doyen-Atrauma</b>               |          |
| Darmklemmen .....                  | 242      |
| <b>Dratigues</b>                   |          |
| Uterusfazzzangen .....             | 284      |
| <b>Duplay</b>                      |          |
| Hakenzangen .....                  | 279      |

|  |          |
|--|----------|
| <b>E</b>                               |          |
| <b>Emmet</b>                           |          |
| Tupferzangen .....                     | 141      |
| <b>Engel</b>                           |          |
| Gipssäge .....                         | 233      |
| <b>Engl. Modell</b>                    |          |
| Tuchklemmen .....                      | 136      |
| <b>Eppendorf</b>                       |          |
| Biopsie Zangen .....                   | 293      |
| <b>Errico</b>                          |          |
| Fräser .....                           | 355      |
| <b>Esmarch</b>                         |          |
| Gipsmesser .....                       | 233      |
| Verbandscheren .....                   | 65       |
| <b>Ewald</b>                           |          |
| Feine anatomische Pinzetten .....      | 78       |
| <b>F</b>                               |          |
| <b>Fadenfänger</b> .....               | 229      |
| <b>Fadengabel</b> .....                | 229      |
| <b>Fadenscherer</b> .....              | 18       |
| <b>Farabeuf</b>                        |          |
| Raspatorien .....                      | 319      |
| Wundhaken .....                        | 159      |
| <b>Farabeuf-Lambotte</b>               |          |
| Knochenhalte-zangen .....              | 339      |
| <b>Farrell</b>                         |          |
| Watteträger .....                      | 204      |
| <b>Faure</b>                           |          |
| Biopsie Zangen .....                   | 292      |
| Peritoneumklemmen .....                | 135      |
| <b>Fehland</b>                         |          |
| Rektum- Anastomosenklemmen .....       | 248      |
| <b>Feilchenfeld</b>                    |          |
| Splitterpinzetten .....                | 101      |
| <b>Fein</b>                            |          |
| Watteträger .....                      | 204      |
| <b>Ferguson</b>                        |          |
| Chirurgische Scheren .....             | 26       |
| Hämorrhoidalzangen .....               | 253      |
| Knochenhalte-zangen .....              | 337      |
| <b>Ferris-Smith</b>                    |          |
| Chirurgische Pinzetten .....           | 96       |
| <b>Finocchietto</b>                    |          |
| Ligaturklemmen .....                   | 131      |
| Nadelhalter .....                      | 215, 223 |
| <b>Finsen</b>                          |          |
| Wundspreizer .....                     | 173      |
| <b>Fomon</b>                           |          |
| Nasenscheren .....                     | 43-44    |
| <b>Förster-Ballenger</b>               |          |
| Schwammzangen .....                    | 143-144  |
| <b>Frazier</b>                         |          |
| Kanülen .....                          | 198      |
| <b>Freeman-Gorney</b>                  |          |
| Präparierscheren .....                 | 40       |
| <b>Freeman-Kaye</b>                    |          |
| Präparierscheren .....                 | 48       |
| <b>Fritsch</b>                         |          |
| Wundhaken .....                        | 165      |
| <b>G</b>                               |          |
| <b>GallenkanalInstrumente</b> .....    | 255      |
| <b>Gallenkanal - Klemmzangen</b> ..... | 254      |
| <b>Gemini</b>                          |          |
| Ligaturklemmen .....                   | 127      |



|                                    |          |  |  |
|------------------------------------|----------|--|--|
| <b>Gerald</b>                      |          |  |  |
| Feine anatomische Pinzetten .....  | 80       |  |  |
| Feine chirurgische Pinzetten ..... | 93       |  |  |
| <b>Gillies</b>                     |          |  |  |
| Feine chirurgische Pinzetten ..... | 91       |  |  |
| Hauthäkchen .....                  | 149      |  |  |
| Nadelhalter .....                  | 216, 211 |  |  |
| <b>Gil-Vernet</b>                  |          |  |  |
| Wundhäkchen .....                  | 150      |  |  |
| <b>Gluck</b>                       |          |  |  |
| Rippenscheren .....                | 70       |  |  |
| <b>Goelet</b>                      |          |  |  |
| Wundhaken .....                    | 158      |  |  |
| <b>Goldmann-Fox</b>                |          |  |  |
| Feine Präparierscheren .....       | 28       |  |  |
| <b>Goldmann-Fox (spezial)</b>      |          |  |  |
| Feine Präparierscheren .....       | 28-29    |  |  |
| <b>Good</b>                        |          |  |  |
| Tonsillen-Scheren .....            | 52       |  |  |
| <b>Gorney</b>                      |          |  |  |
| Präparierscheren .....             | 40-41    |  |  |
| <b>Gosset</b>                      |          |  |  |
| Bauchdeckenhalter .....            | 186      |  |  |
| <b>Gourdet</b>                     |          |  |  |
| Uterusküretten .....               | 296      |  |  |
| <b>Graefe</b>                      |          |  |  |
| Hauthäkchen .....                  | 149      |  |  |
| <b>Grave</b>                       |          |  |  |
| Scheidenspekula .....              | 265      |  |  |
| <b>Green</b>                       |          |  |  |
| Wundhaken .....                    | 164      |  |  |
| <b>Green-Armytage</b>              |          |  |  |
| Uterusklemmzangen .....            | 304      |  |  |
| <b>Gross-Maier</b>                 |          |  |  |
| Kornzangen .....                   | 140      |  |  |
| <b>Grünwald</b>                    |          |  |  |
| Feine anatomische Pinzetten .....  | 83       |  |  |
| <b>Guthrie</b>                     |          |  |  |
| Hauthäkchen .....                  | 149      |  |  |
| <b>Guttman</b>                     |          |  |  |
| Sekretlöffel .....                 | 262      |  |  |
| Uterus-Sekretlöffel .....          | 285      |  |  |
| <b>Guyon</b>                       |          |  |  |
| Katheter-                          |          |  |  |
| Einführungsinstrument .....        | 262      |  |  |
| Nierenklemmen .....                | 256      |  |  |
| <b>Guyon-Atrauma</b>               |          |  |  |
| Nierenklemmen .....                | 256      |  |  |
| <b>H</b>                           |          |  |  |
| <b>Haberer</b>                     |          |  |  |
| Spatel .....                       | 172      |  |  |
| <b>Hajek</b>                       |          |  |  |
| Hämmer .....                       | 368      |  |  |
| <b>Hakansson</b>                   |          |  |  |
| Hohlmeißelzangen .....             | 345      |  |  |
| <b>Halle</b>                       |          |  |  |
| Scharfe Löffel .....               | 316      |  |  |
| <b>Halsey</b>                      |          |  |  |
| Nadelhalter .....                  | 212, 221 |  |  |
| <b>Halsted-Mosquito</b>            |          |  |  |
| Arterienklemmen .....              | 114-115  |  |  |
| <b>Harrington</b>                  |          |  |  |
| Wundhaken .....                    | 169      |  |  |
| <b>Hartmann</b>                    |          |  |  |
| Arterienklemmen .....              | 117      |  |  |
| Hohlmeißelzangen .....             | 346      |  |  |
| <b>Harvey</b>                      |          |  |  |
| Verbandscheren .....               | 64       |  |  |
| <b>Heaney</b>                      |          |  |  |
| Nadelhalter .....                  | 213      |  |  |
| Parametriumklemmen .....           | 287      |  |  |
| Wundhaken .....                    | 169      |  |  |
| <b>Heaney-Ballentine</b>           |          |  |  |
| Hysterektomieklappen .....         | 288      |  |  |
| <b>Heaney-Slim</b>                 |          |  |  |
| Parametriumklemmen .....           | 287      |  |  |
| <b>Heath</b>                       |          |  |  |
| Hämmer .....                       | 367      |  |  |
| <b>Hegar</b>                       |          |  |  |
| Nadelhalter .....                  | 214      |  |  |
| Uterusdilatoren .....              | 277      |  |  |
| <b>Hegar-Baumgartner</b>           |          |  |  |
| Nadelhalter .....                  | 212, 219 |  |  |
| <b>Hegar-Vascular</b>              |          |  |  |
| Nadelhalter .....                  | 221      |  |  |
| <b>Hegemann-Diethrich</b>          |          |  |  |
| Gefäßscheren .....                 | 48, 49   |  |  |
| <b>Hegenbarth</b>                  |          |  |  |
| Klammeranlegepinzetten .....       | 230      |  |  |
| <b>Heiss</b>                       |          |  |  |
| Ligaturklemmen .....               | 128      |  |  |
| Wundspreizer .....                 | 173      |  |  |
| <b>Henley</b>                      |          |  |  |
| Wundspreizer .....                 | 177, 178 |  |  |
| <b>Henning</b>                     |          |  |  |
| Gipsspreizer .....                 | 233      |  |  |
| <b>Heymann</b>                     |          |  |  |
| Nasenscheren .....                 | 42       |  |  |
| <b>Heywood-Smith</b>               |          |  |  |
| Hämorrhoidalzangen .....           | 253      |  |  |
| Polypen- und Ovarienzangen .....   | 283      |  |  |
| <b>Hibbs</b>                       |          |  |  |
| Flachmeißel .....                  | 311      |  |  |
| Hohlmeißel .....                   | 311      |  |  |
| Osteotome .....                    | 311      |  |  |
| Wundhaken .....                    | 170      |  |  |
| <b>Hoen</b>                        |          |  |  |
| Raspatorien .....                  | 325      |  |  |
| <b>Hohmann</b>                     |          |  |  |
| Knochenhebel .....                 | 329, 330 |  |  |
| <b>Hohmann-Aldinger</b>            |          |  |  |
| Knochenhebel .....                 | 330      |  |  |
| <b>Hoke</b>                        |          |  |  |
| Osteotome .....                    | 307      |  |  |
| <b>Hopkins</b>                     |          |  |  |
| Gipsmesser .....                   | 233      |  |  |
| <b>Hösel</b>                       |          |  |  |
| Scheidenhalter .....               | 275      |  |  |
| Wundhaken .....                    | 163      |  |  |
| <b>Hudson</b>                      |          |  |  |
| Bohrapparate .....                 | 355      |  |  |
| Fräser .....                       | 355      |  |  |
| Griff .....                        | 355      |  |  |
| <b>Hunter</b>                      |          |  |  |
| Splitterpinzetten .....            | 101      |  |  |
| <b>I</b>                           |          |  |  |
| Instrumente für Fingernägel .....  | 352      |  |  |
| Instrumentenkasten .....           | 375      |  |  |
| Instrumentenschalen .....          | 375      |  |  |
| Irisschere .....                   | 29       |  |  |
| <b>Israel</b>                      |          |  |  |
| Wundhaken .....                    | 160      |  |  |
| <b>Iterson</b>                     |          |  |  |
| Wundhäkchen .....                  | 153      |  |  |
| <b>Ives-Fansler</b>                |          |  |  |
| Anuskope .....                     | 251      |  |  |
| <b>J</b>                           |          |  |  |
| <b>Jackson</b>                     |          |  |  |
| Scheidenspekula .....              | 268      |  |  |
| Wundhäkchen .....                  | 150, 152 |  |  |
| <b>Jacobs</b>                      |          |  |  |
| Hakenzangen .....                  | 282      |  |  |
| <b>Jacobsen</b>                    |          |  |  |
| Anatomische Mikro-Pinzetten .....  | 102      |  |  |
| <b>Jacobson</b>                    |          |  |  |
| Arterienklemmen .....              | 114      |  |  |
| Mikro Federscheren .....           | 17       |  |  |
| Mikro-Nadelhalter .....            | 208      |  |  |
| <b>Jacobson-Adson</b>              |          |  |  |
| Feine anatomische Pinzetten .....  | 78       |  |  |
| <b>Jameson</b>                     |          |  |  |
| Nadelhalter .....                  | 216      |  |  |
| <b>Jansen</b>                      |          |  |  |
| Hohlmeißelzangen .....             | 346-346  |  |  |
| Ohrpinzetten .....                 | 87       |  |  |
| Raspatorien .....                  | 320      |  |  |
| Scharfe Löffel .....               | 317      |  |  |
| Wundspreizer .....                 | 173      |  |  |
| <b>Jansen-Gruenwald</b>            |          |  |  |
| Ohrpinzetten .....                 | 87       |  |  |
| <b>Jobson-Horne</b>                |          |  |  |
| Watteträger .....                  | 204      |  |  |
| <b>Johns-Hopkins</b>               |          |  |  |
| Bulldogklemmen .....               | 145      |  |  |
| Ligaturklemmen .....               | 123      |  |  |
| <b>Joll (Friedmann)</b>            |          |  |  |
| Thyreoid- und Vulvaspreizer .....  | 182      |  |  |
| <b>Jones</b>                       |          |  |  |
| Tuchklemmen .....                  | 136      |  |  |
| <b>Jorgensen</b>                   |          |  |  |
| Gefäßscheren .....                 | 46       |  |  |
| <b>Joseph</b>                      |          |  |  |
| Präparierscheren .....             | 39       |  |  |
| Raspatorien .....                  | 321      |  |  |
| <b>Judd-Allis</b>                  |          |  |  |
| Darm- und Gewebefasszangen .....   | 310      |  |  |
| <b>K</b>                           |          |  |  |
| <b>Kallmorgen</b>                  |          |  |  |
| Scheidenspekula-Sets .....         | 267      |  |  |
| <b>Kalt</b>                        |          |  |  |
| Mikro-Nadelhalter .....            | 211      |  |  |
| <b>Kantrowitz</b>                  |          |  |  |
| Ligaturklemmen .....               | 123      |  |  |
| <b>Kazanjan</b>                    |          |  |  |
| Knochensplitterzangen .....        | 351      |  |  |
| <b>Kelly</b>                       |          |  |  |
| Arterienklemmen .....              | 110      |  |  |
| Fistelscheren .....                | 56       |  |  |
| Polypen- und Ovarienzangen .....   | 283      |  |  |
| Proktoskope .....                  | 251      |  |  |
| Wundhaken .....                    | 166, 171 |  |  |
| <b>Kelly-Rankin</b>                |          |  |  |
| Arterienklemmen .....              | 110      |  |  |
| <b>Kern</b>                        |          |  |  |
| Knochenhalte-zangen .....          | 337      |  |  |





|  |               |  |
|--|---------------|--|
| <b>Kevorkian</b>                           |               |  |
| Biopsie Zangen .....                       | 293           |  |
| <b>Kielland</b>                            |               |  |
| Geburtszangen .....                        | 302           |  |
| <b>Kilner</b>                              |               |  |
| Hauthäkchen .....                          | 148           |  |
| Nadelhalter .....                          | 221           |  |
| Nasenschere .....                          | 42            |  |
| Präparierscheren .....                     | 40            |  |
| <b>Kirschner</b>                           |               |  |
| Bauchdeckenhalter .....                    | 191           |  |
| <b>Klapp</b>                               |               |  |
| Sehnenscheidenhaken .....                  | 369           |  |
| <b>Kleinert-Kutz</b>                       |               |  |
| Feine Wundhäkchen .....                    | 149           |  |
| Sehnendurchziehzangen .....                | 370           |  |
| <b>Kleinschmidt</b>                        |               |  |
| Blinddarmklemmen .....                     | 245           |  |
| <b>Klima-Rosegger</b>                      |               |  |
| Sternal-Punktionskanülen .....             | 197           |  |
| <b>Klingenberg-Loth</b>                    |               |  |
| Gefäßscheren .....                         | 47            |  |
| <b>Knapp</b>                               |               |  |
| Augenschere .....                          | 18            |  |
| Wundhäkchen .....                          | 152           |  |
| <b>Knowles</b>                             |               |  |
| Verbandscheren .....                       | 67            |  |
| <b>Kocher</b>                              |               |  |
| Arterienklemmen .....                      | 111           |  |
| Darmklemmen .....                          | 244           |  |
| Knochenhaken .....                         | 333           |  |
| Wundhaken .....                            | 162, 163, 166 |  |
| <b>Kocher-Atrauma</b>                      |               |  |
| Darmklemmen .....                          | 244           |  |
| <b>Kocher-Langenbeck</b>                   |               |  |
| Wundhaken .....                            | 163           |  |
| <b>König</b>                               |               |  |
| Elevatorien .....                          | 327           |  |
| Führungs-Hohlsonden .....                  | 229           |  |
| <b>Körte</b>                               |               |  |
| Wundhaken .....                            | 160           |  |
| <b>Kristeller</b>                          |               |  |
| Scheidenspekula-Sets .....                 | 268-271       |  |
| <b>Kronecker</b>                           |               |  |
| Unterbindungsadeln .....                   | 225           |  |
| <b>Kuehne</b>                              |               |  |
| Cilienpinzetten .....                      | 104           |  |
| <b>L</b>                                   |               |  |
| <b>La Grange</b>                           |               |  |
| Zahnfleischscheren .....                   | 62            |  |
| <b>Lahey</b>                               |               |  |
| Ligaturklemmen .....                       | 131           |  |
| Wundhaken .....                            | 161           |  |
| <b>Lambotte</b>                            |               |  |
| Knochenhalte-zangen .....                  | 339           |  |
| Osteotome .....                            | 309           |  |
| Raspatorien .....                          | 320           |  |
| <b>Landolt</b>                             |               |  |
| Enukleationsscheren .....                  | 30            |  |
| <b>Lane</b>                                |               |  |
| Chirurgische Pinzetten .....               | 97            |  |
| Knochenhalte-zangen .....                  | 340           |  |
| Magen- und Darm-<br>Zwillingsklemmen ..... | 247           |  |
| Tuchklemmen .....                          | 136           |  |
| <b>Lane-Trethowan</b>                      |               |  |
| Knochenhebel .....                         | 330           |  |
| <b>Langenbeck</b>                          |               |  |
| Elevatorien .....                          | 325           |  |
| Knochenhalte-zangen .....                  | 336           |  |
| Raspatorien .....                          | 319           |  |
| Resektionsmesser .....                     | 8             |  |
| Sägen .....                                | 353           |  |
| Wundhaken .....                            | 160-162       |  |
| <b>Lawrence</b>                            |               |  |
| Ligaturklemmen .....                       | 131           |  |
| <b>Lazar</b>                               |               |  |
| Mikro-Nahtpinzetten .....                  | 73            |  |
| <b>Leksell</b>                             |               |  |
| Hohlmeißelzangen .....                     | 349           |  |
| <b>Lempert</b>                             |               |  |
| Hohlmeißelzangen .....                     | 344           |  |
| <b>Leriche</b>                             |               |  |
| Arterienklemmen .....                      | 113           |  |
| <b>Lewin</b>                               |               |  |
| Knochenhalte-zangen .....                  | 336           |  |
| <b>Lexer</b>                               |               |  |
| Hohlmeißel .....                           | 310, 312      |  |
| Osteotome .....                            | 310           |  |
| <b>Lexer-Fino</b>                          |               |  |
| Präparierscheren .....                     | 30            |  |
| Ligaturklemmen .....                       | 123-132       |  |
| <b>Lister</b>                              |               |  |
| Sinusklemmen .....                         | 139           |  |
| Verbandscheren .....                       | 64-65         |  |
| <b>Lister-Excentric</b>                    |               |  |
| Verbandscheren .....                       | 65            |  |
| <b>Liston</b>                              |               |  |
| Amputationsmesser .....                    | 7             |  |
| Knochensplitterzangen .....                | 350           |  |
| <b>Liston-Key-Horsley</b>                  |               |  |
| Knochensplitterzangen .....                | 351           |  |
| <b>Littauer</b>                            |               |  |
| Ligaturscheren .....                       | 54            |  |
| <b>Littler</b>                             |               |  |
| Ligaturscheren .....                       | 54            |  |
| <b>Littlewood</b>                          |               |  |
| Darm- und Gewebefasszangen .....           | 238           |  |
| <b>Lockart-Mummary</b>                     |               |  |
| Fistel-sonden .....                        | 203           |  |
| <b>Locklin</b>                             |               |  |
| Zahnfleischscheren .....                   | 62            |  |
| <b>Lockwood</b>                            |               |  |
| Darm- und Gewebefasszangen .....           | 238           |  |
| <b>Lorenz</b>                              |               |  |
| Verbandscheren .....                       | 66            |  |
| <b>Lorna</b>                               |               |  |
| Tuchklemmen .....                          | 137           |  |
| <b>Loute</b>                               |               |  |
| Drahtspanninstrumente .....                | 366           |  |
| <b>Lower</b>                               |               |  |
| Gallenkanalklemmzangen .....               | 127           |  |
| <b>Lowman</b>                              |               |  |
| Knochenhalte-zangen .....                  | 341           |  |
| <b>Lucae</b>                               |               |  |
| Hämmer .....                               | 368           |  |
| Ohrpinzetten .....                         | 87            |  |
| <b>Lucas</b>                               |               |  |
| Flachmeißel .....                          | 306           |  |
| Hohlmeißel .....                           | 306           |  |
| <b>Luer</b>                                |               |  |
| Hohlmeißelzangen .....                     | 345           |  |
| Wundhaken .....                            | 155           |  |
| <b>Luer-Friedmann</b>                      |               |  |
| Hohlmeißelzangen .....                     | 342           |  |
| <b>Luer-Koerte</b>                         |               |  |
| Gallenkanal Instrumente .....              | 255           |  |
| <b>M</b>                                   |               |  |
| <b>Magill</b>                              |               |  |
| Katheterzangen .....                       | 199           |  |
| <b>Marquardt</b>                           |               |  |
| Hohlmeißelzangen .....                     | 347           |  |
| <b>Martin</b>                              |               |  |
| Knochenhalte-zangen .....                  | 335           |  |
| Wundhaken .....                            | 167           |  |
| <b>Martin-Cartilage</b>                    |               |  |
| Knorpelscheren .....                       | 46            |  |
| Martini<br>Scharfe Löffel .....            | 317           |  |
| <b>Martin (Simpson)</b>                    |               |  |
| Uterussonden .....                         | 278           |  |
| <b>Masson</b>                              |               |  |
| Nadelhalter .....                          | 215, 223      |  |
| <b>Mathieu</b>                             |               |  |
| Nadelhalter .....                          | 217, 224      |  |
| Rektum-Spekula .....                       | 250           |  |
| Schedenspekula .....                       | 273           |  |
| Wundhaken .....                            | 159           |  |
| <b>Mayfield</b>                            |               |  |
| Hohlmeißelzangen .....                     | 346           |  |
| <b>Mayo</b>                                |               |  |
| Fasspinzetten .....                        | 100           |  |
| Präparierscheren .....                     | 31,32         |  |
| Sterilisierklammern .....                  | 372           |  |
| <b>Mayo-Adams</b>                          |               |  |
| Wundspreizer .....                         | 176-178       |  |
| <b>Mayo-Hegar</b>                          |               |  |
| Nadelhalter .....                          | 213, 218, 219 |  |
| <b>Mayo-Noble</b>                          |               |  |
| Präparierscheren .....                     | 34            |  |
| <b>Mayo-Robson</b>                         |               |  |
| Darmklemmen .....                          | 243           |  |
| <b>Mayo-Robson Atrauma</b>                 |               |  |
| Darmklemmen .....                          | 243           |  |
| <b>Mayo-Stille</b>                         |               |  |
| Präparierscheren .....                     | 33            |  |
| <b>Mc Donald</b>                           |               |  |
| Elevatorien .....                          | 327           |  |
| <b>Mc Givney</b>                           |               |  |
| Hämorrhoidalzangen .....                   | 253           |  |
| <b>Mc Indoe</b>                            |               |  |
| Feine anatomische Pinzetten .....          | 79            |  |
| Feine chirurgische Pinzetten .....         | 91            |  |
| Gefäßscheren .....                         | 46            |  |
| Knochensplitterzangen .....                | 350           |  |
| <b>Mc Kenzil</b>                           |               |  |
| Fräser .....                               | 355           |  |
| <b>Mead</b>                                |               |  |
| Hämmer .....                               | 368           |  |
| Hohlmeißelzangen .....                     | 344           |  |
| <b>Meeker</b>                              |               |  |
| Ligaturklemmen .....                       | 127           |  |
| <b>Metzenbaum</b>                          |               |  |
| Präparierscheren .....                     | 35-38         |  |
| <b>Metzenbaum-Fino</b>                     |               |  |
| Präparierscheren .....                     | 35-37         |  |
| <b>Metzenbaum-S</b>                        |               |  |
| Präparierscheren .....                     | 38            |  |
| <b>Meyering</b>                            |               |  |
| Wundhaken .....                            | 169           |  |



|                                    |          |  |  |
|------------------------------------|----------|--|--|
| <b>Michel</b>                      |          |  |  |
| Klammeranlegepinzetten .....       | 230      |  |  |
| Klammeranlege- und                 |          |  |  |
| Entfernungs- zangen .....          | 230      |  |  |
| Wundklammerbesteck .....           | 230      |  |  |
| <b>Michel Mod.</b>                 |          |  |  |
| Klammeranlege- und                 |          |  |  |
| Entfernungs- zangen .....          | 230      |  |  |
| <b>Micro Adson</b>                 |          |  |  |
| Feine anatomische Pinzetten .....  | 78       |  |  |
| Feine chirurgische Pinzetten ..... | 89       |  |  |
| <b>Micro-Mosquito</b>              |          |  |  |
| Arterienklemmen .....              | 116      |  |  |
| <b>Micro-Ryder</b>                 |          |  |  |
| Nadelhalter .....                  | 222      |  |  |
| <b>Micro-Semken</b>                |          |  |  |
| Feine chirurgische Pinzetten ..... | 90       |  |  |
| <b>Middeldorpf</b>                 |          |  |  |
| Wundhaken .....                    | 164      |  |  |
| <b>Mikulicz</b>                    |          |  |  |
| Peritoneumklemmen .....            | 134-135  |  |  |
| Wundhaken .....                    | 170-171  |  |  |
| <b>Miller</b>                      |          |  |  |
| Knochenraspeln .....               | 318      |  |  |
| <b>Millin</b>                      |          |  |  |
| Blasenhalsspreizer .....           | 328      |  |  |
| <b>Mini-Friedmann</b>              |          |  |  |
| Hohlmeißelzangen .....             | 342      |  |  |
| <b>Mini-Gemini</b>                 |          |  |  |
| Ligaturklemmen .....               | 139      |  |  |
| <b>Mini-Hohmann</b>                |          |  |  |
| Knochenhebel .....                 | 328      |  |  |
| <b>Mini-Lambotte</b>               |          |  |  |
| Osteotome .....                    | 309      |  |  |
| <b>Mini-Langenbeck</b>             |          |  |  |
| Wundhäkchen .....                  | 150      |  |  |
| <b>Mini-Lexer</b>                  |          |  |  |
| Hohlmeißel .....                   | 310      |  |  |
| Osteotome .....                    | 310      |  |  |
| <b>Mini-Lowman</b>                 |          |  |  |
| Knochenhalte zangen .....          | 341      |  |  |
| <b>Mixter</b>                      |          |  |  |
| Ligaturklemmen .....               | 130      |  |  |
| <b>Mod. Bonn</b>                   |          |  |  |
| Feine Präparierscheren .....       | 27       |  |  |
| <b>Modell USA</b>                  |          |  |  |
| Anatomische Pinzetten .....        | 85       |  |  |
| Chirurgische Pinzetten .....       | 96       |  |  |
| <b>Mod. USA</b>                    |          |  |  |
| Gipsspreizer .....                 | 234      |  |  |
| Nabelschnurscheren .....           | 58       |  |  |
| <b>Mod. Wien</b>                   |          |  |  |
| Fadenfänger .....                  | 229      |  |  |
| <b>Mollison</b>                    |          |  |  |
| Wundspreizer .....                 | 175-176  |  |  |
| <b>Morris</b>                      |          |  |  |
| Wundhaken .....                    | 164      |  |  |
| <b>Murphy-Lane</b>                 |          |  |  |
| Knochenhebel .....                 | 331      |  |  |
| <b>Museux</b>                      |          |  |  |
| Hakenzangen .....                  | 238-283  |  |  |
| <b>N</b>                           |          |  |  |
| Nabelschnurklemme .....            | 300      |  |  |
| Nabelschnurscheren .....           | 82       |  |  |
| Nagelausreißzange .....            | 352      |  |  |
| <b>Nägele</b>                      |          |  |  |
| Geburtszangen .....                | 302      |  |  |
| <b>Negus</b>                       |          |  |  |
| Tonsillenklemmen .....             | 133      |  |  |
| <b>Neivert</b>                     |          |  |  |
| Nadelhalter .....                  | 217      |  |  |
| <b>Nelaton</b>                     |          |  |  |
| Hohlsonden .....                   | 202      |  |  |
| <b>Nelson</b>                      |          |  |  |
| Darm- und Lungenpinzetten .....    | 99       |  |  |
| <b>New Orleans</b>                 |          |  |  |
| Nadelhalter .....                  | 212      |  |  |
| <b>News</b>                        |          |  |  |
| Trachealhäkchen .....              | 150      |  |  |
| <b>Northbent</b>                   |          |  |  |
| Ligaturscheren .....               | 54       |  |  |
| <b>Noto</b>                        |          |  |  |
| Polypen- und                       |          |  |  |
| Ovarienzangen .....                | 283      |  |  |
| <b>Novak</b>                       |          |  |  |
| Biopsie Instrumente .....          | 290      |  |  |
| <b>Noyes</b>                       |          |  |  |
| Iridektomieschere .....            | 13       |  |  |
| <b>O</b>                           |          |  |  |
| <b>Ochsner-Kocher</b>              |          |  |  |
| Arterienklemmen .....              | 108-110  |  |  |
| <b>O' Connor</b>                   |          |  |  |
| Feine Wundhäkchen .....            | 149      |  |  |
| <b>Oehler</b>                      |          |  |  |
| Feine chirurgische Pinzetten ..... | 92       |  |  |
| <b>Ollier</b>                      |          |  |  |
| Wundhaken .....                    | 160      |  |  |
| <b>Olsen-Hegar</b>                 |          |  |  |
| Nadelhalter .....                  | 216      |  |  |
| <b>Ombredanne</b>                  |          |  |  |
| Hämmer .....                       | 367      |  |  |
| <b>O'Sullivan-O'Connor</b>         |          |  |  |
| Bauchdeckenhalter .....            | 193      |  |  |
| <b>Overholt-Geissendörfer</b>      |          |  |  |
| Ligaturklemmen .....               | 162-163  |  |  |
| <b>Overholt-Mixter</b>             |          |  |  |
| Ligaturklemmen .....               | 128      |  |  |
| <b>Overholt-S</b>                  |          |  |  |
| Ligaturklemmen .....               | 124      |  |  |
| <b>P</b>                           |          |  |  |
| <b>Parker</b>                      |          |  |  |
| Wundhaken .....                    | 158      |  |  |
| <b>Parker-Langenbeck</b>           |          |  |  |
| Wundhaken .....                    | 158      |  |  |
| <b>Parker-Mott</b>                 |          |  |  |
| Wundhaken .....                    | 158      |  |  |
| <b>Partsch</b>                     |          |  |  |
| Meißel und Osteotome .....         | 307      |  |  |
| <b>Payr</b>                        |          |  |  |
| Führungs-Hohlsonden .....          | 228      |  |  |
| Magen- und                         |          |  |  |
| Darmquetschklemmen .....           | 246      |  |  |
| <b>Pean</b>                        |          |  |  |
| Arterienklemmen .....              | 111, 117 |  |  |
| <b>Peck-Joseph</b>                 |          |  |  |
| Präparierscheren .....             | 39       |  |  |
| <b>Peers-Bertram</b>               |          |  |  |
| Tuchklemmen .....                  | 137      |  |  |
| <b>Peet</b>                        |          |  |  |
| Splitterzangen .....               | 102      |  |  |
| <b>Pennington</b>                  |          |  |  |
| Gewebe fäßzange .....              | 118      |  |  |
| <b>Percy</b>                       |          |  |  |
| Amputationsretraktor .....         | 339      |  |  |
| <b>Perthes</b>                     |          |  |  |
| Reibahlen .....                    | 358      |  |  |
| <b>Phaneuf</b>                     |          |  |  |
| Hysterektomieklemmen .....         | 288      |  |  |
| <b>Piper</b>                       |          |  |  |
| Geburtszangen .....                | 302      |  |  |
| <b>Plester</b>                     |          |  |  |
| Wundspreizer .....                 | 174      |  |  |
| <b>Poole</b>                       |          |  |  |
| Kanülen .....                      | 197      |  |  |
| <b>Potts-Smith</b>                 |          |  |  |
| Feine anatomische Pinzetten .....  | 83       |  |  |
| Feine chirurgische Pinzetten ..... | 92       |  |  |
| Gefäßscheren .....                 | 45-47    |  |  |
| <b>Pozzi</b>                       |          |  |  |
| Hakenzangen .....                  | 279      |  |  |
| <b>Pratt</b>                       |          |  |  |
| Fistelsonden .....                 | 203      |  |  |
| Hakenzangen .....                  | 282      |  |  |
| Hämorrhoidalzangen .....           | 253      |  |  |
| Rektum-Spekula .....               | 249      |  |  |
| <b>Providence</b>                  |          |  |  |
| Arterienklemmen .....              | 114      |  |  |
| <b>Putti</b>                       |          |  |  |
| Knochenraspeln .....               | 318      |  |  |
| <b>Q</b>                           |          |  |  |
| <b>Quervain</b>                    |          |  |  |
| Elevatorien .....                  | 326      |  |  |
| <b>R</b>                           |          |  |  |
| <b>Radolf</b>                      |          |  |  |
| Nagelausreißzange .....            | 352      |  |  |
| <b>Ragnell-Davis</b>               |          |  |  |
| Wundhaken .....                    | 156      |  |  |
| <b>Ralk</b>                        |          |  |  |
| Splitterzangen .....               | 102      |  |  |
| <b>Ramplay</b>                     |          |  |  |
| Schwammzangen .....                | 114      |  |  |
| <b>Randall</b>                     |          |  |  |
| Biopsie Instrumente .....          | 290      |  |  |
| Nierensteinzangen .....            | 257      |  |  |
| <b>Recamier</b>                    |          |  |  |
| Uterusküretten .....               | 295-296  |  |  |
| <b>Redon</b>                       |          |  |  |
| Nadeln .....                       | 200      |  |  |
| <b>Reiner</b>                      |          |  |  |
| Gipsmesser .....                   | 233      |  |  |
| <b>Resano</b>                      |          |  |  |
| Kapselschere .....                 | 46       |  |  |
| Rektum- Anastomosenklemmen .....   | 248      |  |  |
| <b>Reverdin</b>                    |          |  |  |
| Nadeln .....                       | 227      |  |  |
| Spatel .....                       | 172      |  |  |
| <b>Reynolds</b>                    |          |  |  |
| Feine Präparierscheren .....       | 29       |  |  |
| Präparierscheren .....             | 57       |  |  |
| <b>Ricard</b>                      |          |  |  |
| Bauchdeckenhalter .....            | 185      |  |  |
| <b>Richardson</b>                  |          |  |  |
| Wundhaken .....                    | 165      |  |  |
| <b>Richardson-Eastman</b>          |          |  |  |
| Wundhaken .....                    | 165      |  |  |
| <b>Richter</b>                     |          |  |  |
| Chirurgische Scheren .....         | 26       |  |  |



**Richter-Heath**  
Klammerzange ..... 230

**Roberts**  
Arterienklemmen ..... 122

**Rochard**  
Bauchdeckenhalter ..... 194

**Rochester-Carmalt**  
Arterienklemmen ..... 119

**Rochester-Pean**  
Arterienklemmen ..... 106-107

**Röttgen-Ruskin**  
Hohlmeißelzangen ..... 347

**Roux**  
Wundhaken ..... 157

**Rumel**  
Ligaturklemmen ..... 123  
Runde Behältnisse ..... 374  
Rundzange ..... 352

**Ruskin**  
Hohlmeißelzangen ..... 346

**Ruskin-Liston**  
Knochensplitterzangen ..... 351

**Russ. Modell**  
Fasspinzetten ..... 100

**Ryder**  
Nadelhalter ..... 222

**S**

Sägen ..... 353-354

Salpingograph ..... 298-299

**Sänger**  
Abortuszangen ..... 304

**Sanvenero**  
Feine Scheren ..... 22

**Sarot**  
Arterienklemmen ..... 121  
Nadelhalter ..... 224

**Satinsky**  
Gefäßscheren ..... 47

**Satterlee**  
Sägen ..... 353

**Sauerbruch**  
Wundhaken ..... 167  
Sterilisierzange ..... 372

**Schaaf**  
Cilienpinzetten ..... 103

**Schädel**  
Tuchklemmen ..... 136

**Schede**  
Scharfe Löffel ..... 315

**Schink**  
Dermatom ..... 9

**Schmieden**  
Führungs-Hohlsonden ..... 228

**Schmieden-Payr**  
Führungs-Hohlsonden ..... 228

**Schneider-Sauerbruch**  
Raspatorien ..... 320

**Schröder**  
Hakenzangen ..... 279-281  
Uteruslöffel ..... 294

**Schubert**  
Biopsie Zangen ..... 291

**Schuknecht**  
Kanülen ..... 198

**Schultze**  
Salpingograph ..... 298

**Schumacher**  
Biopsie Zangen ..... 292, 293  
Nabelschnurscheren ..... 58

**Sedillot**  
Raspatorien ..... 319  
Seitliches Spekulum ..... 275  
Sekretlöffel ..... 262

**Sellheim**  
Geburtslöffel ..... 300

**Semb**  
Hohlmeißelzangen ..... 348  
Knochenhalte zangen ..... 338  
Raspatorien ..... 322

**Semken**  
Feine anatomische Pinzetten ..... 79  
Feine chirurgische Pinzetten ..... 91

**Semm**  
Bauchdeckenhalter ..... 190

**Senn-Green**  
Wundhaken ..... 157

**Senn-Mueller**  
Wundhaken ..... 156

**Seutin**  
Knochenschere n ..... 69

**Siebold**  
Uterusscheren ..... 57

**Silver**  
Dermatom ..... 9

**Simon**  
Fistelhaken ..... 285  
Uteruslöffel ..... 294  
Wundhaken ..... 166

**Simpson**  
Geburtszangen ..... 301

**Simpson-Braun**  
Geburtszangen ..... 301

**Sims**  
Gynäkologische Scheren ..... 55  
Rektum-Spekula ..... 246, 250  
Scheidenspekula ..... 267  
Scheidenspekula-Sets ..... 267  
Uterusküretten ..... 296  
Uterussonden ..... 364

**Sims-Maier**  
Kornzangen ..... 139

**Singley-Tuttle**  
Darm- und Lungenpinzetten ..... 99

**Smillie**  
Meniskussmesser ..... 334

**Smith-Buie**  
Analspreizer ..... 251

**Smith (Mod. USA)**  
Verbandscheren ..... 67

**Smith-Petersen**  
Hohlmeißel ..... 308  
Hohlmeißelzangen ..... 308  
Osteotome ..... 308

**Somer**  
Uterusfasszangen ..... 284

**Spencer**  
Ligaturscheren ..... 54

**Spencer-Wells**  
Ligaturklemmen ..... 132

**Spratt**  
Scharfe Löffel ..... 314

**Stacke**  
Ohrsonden ..... 202

**Standard**  
Anatomische Pinzetten ..... 78, 84

**Standard Adson**  
Feine chirurgische Pinzetten ..... 90

**Steinmann**  
Sehnenhalte zangen ..... 369

**Stellbrink**  
Hohlmeißelzangen ..... 342

**Stevens**  
Feine Scheren ..... 19  
Sehnscheren ..... 27

**Stieglitz**  
Splitterzangen ..... 102

**Stille**  
Anatomische Pinzetten ..... 84  
Bohrapparate ..... 356  
Flachmeißel ..... 311  
Gipsschere ..... 234  
Gipsscheren ..... 68  
Hohlmeißel ..... 311  
Hohlmeißelzangen ..... 347  
Osteotome ..... 311

**Stille-Barraya**  
Chirurgische Pinzetten ..... 97

**Stille-Liston**  
Knochensplitterzangen ..... 351

**Stille-Luer**  
Hohlmeißelzangen ..... 348

**Stille-Ruskin**  
Hohlmeißelzangen ..... 348

**Stockmann**  
Penisklemmen ..... 262

**Strandell-Stille**  
Sehnscheidenhaken ..... 369

**Stratte**  
Nadelhalter ..... 223

**Strauss**  
Penisklemmen ..... 262

**Strully**  
Gefäßscheren ..... 49

**Sullivan**  
Zahnfleis chscheren ..... 62

**T**

**Taylor**  
Feine anatomische Pinzetten ..... 81  
Feine chirurgische Pinzetten ..... 93, 94  
Spinalhaken ..... 334

**Teale**  
Hakenzangen ..... 282

**Thomas-Gaylor**  
Biopsie Zangen ..... 291

**Thoms-Allis**  
Darm- und Gewebefasszangen ..... 238

**Tohoku**  
Tuchklemmen ..... 137

**Tönnis**  
Tonsillen-Scheren ..... 51

**Tönnis-Adson**  
Tonsillen-Scheren ..... 51

**Tönnis-Adson Fino**  
Arteriotomie Schere ..... 74  
Tonsillen-Scheren ..... 51

**Travers**  
Wundspreizer ..... 179

**Trélat**  
Scheidenspekula ..... 265

**Troeltsch**  
Ohrpinzetten ..... 88

**Troeltsch (Wilde)**  
Ohrpinzetten ..... 88



|                                    |               |
|------------------------------------|---------------|
| <b>Troutman-Chris</b>              |               |
| Rasierklingenbrecher .....         | 6             |
| <b>Tübinger Modell</b>             |               |
| Wundspreizer .....                 | 176           |
| <b>Tuffier</b>                     |               |
| Gewerbefäßzange .....              | 118           |
| Spatel .....                       | 172           |
| <b>U</b>                           |               |
| <b>Uffenrode</b>                   |               |
| Scharfe Löffel .....               | 315           |
| <b>Ulrich</b>                      |               |
| Kornzangen .....                   | 139           |
| <b>Universal</b>                   |               |
| Sterilisierzangen .....            | 372           |
| Trokar-Set .....                   | 196           |
| <b>V</b>                           |               |
| Vaginalklemmen .....               | 290           |
| <b>Valleix</b>                     |               |
| Uterussonden .....                 | 278           |
| <b>Van Burren</b>                  |               |
| Urethrale Bougies .....            | 261           |
| <b>Van Doren</b>                   |               |
| Biopsie Zangen .....               | 292           |
| <b>Vannas</b>                      |               |
| Mikro Federschere .....            | 13, 17        |
| <b>Verbrugge</b>                   |               |
| Knochenhalte-zangen .....          | 338           |
| <b>Verbrugge-Müller</b>            |               |
| Knochenhebel .....                 | 329           |
| <b>Virchow</b>                     |               |
| Seziermesser .....                 | 8             |
| <b>Vise</b>                        |               |
| Mikro-Uhrmacher-Pinzetten .....    | 72            |
| <b>Volkman</b>                     |               |
| Knochenhaken .....                 | 332           |
| Scharfe Löffel .....               | 313, 315, 316 |
| <b>W</b>                           |               |
| <b>Wagenstein</b>                  |               |
| Nadelhalter .....                  | 215, 223      |
| <b>Wagner</b>                      |               |
| Feine Chirurgische Scheren .....   | 23            |
| <b>Waldmann</b>                    |               |
| Damm-(Episiotomie-) Scheren .....  | 59            |
| <b>Walter-Carmalt</b>              |               |
| Splitterringen .....               | 101           |
| <b>Walton</b>                      |               |
| Feine Scheren .....                | 19, 22        |
| <b>Wangenstein</b>                 |               |
| Anatomische Pinzetten .....        | 85            |
| <b>Waugh</b>                       |               |
| Feine anatomische Pinzetten .....  | 80            |
| Feine chirurgische Pinzetten ..... | 92            |
| <b>Webster</b>                     |               |
| Nadelhalter .....                  | 212, 217      |
| <b>Weitlaner</b>                   |               |
| Wundspreizer .....                 | 175, 180      |
| <b>Weitlaner-Baby</b>              |               |
| Wundspreizer .....                 | 180           |
| <b>Weitlaner-Wullstein</b>         |               |
| Wundspreizer .....                 | 175           |
| <b>Weller</b>                      |               |
| Präparierscheren .....             | 38            |
| <b>Wertheim</b>                    |               |
| Gynäkologische Scheren .....       | 55            |
| Hysterektomieklemmen .....         | 288           |
| Peritoneumklemmen .....            | 286           |
| <b>Wertheim-Cullen</b>             |               |
| Hysterektomieklemmen .....         | 289           |
| <b>Westcott</b>                    |               |
| Sehnenscheren .....                | 13, 15        |
| <b>Williger</b>                    |               |
| Elevatorien .....                  | 326           |
| Raspatorien .....                  | 320           |
| Scharfe Löffel .....               | 315, 317      |
| <b>Wilmer</b>                      |               |
| Feine Präparierscheren .....       | 27            |
| <b>Winter</b>                      |               |
| Abortuszangen .....                | 303           |
| <b>Wolff</b>                       |               |
| Gipsabreißzange .....              | 234           |
| <b>Wrigley</b>                     |               |
| Geburtszangen .....                | 301           |
| <b>Wylie</b>                       |               |
| Wundhaken .....                    | 164           |
| <b>Y</b>                           |               |
| <b>Yankauer-Standard</b>           |               |
| Kanülen .....                      | 197           |
| <b>Yasargil</b>                    |               |
| Anatomische Mikro-Pinzetten .....  | 75            |
| Mikro-Tumorfäßpinzetten .....      | 76            |
| <b>Young</b>                       |               |
| Prostatahaken .....                | 259           |
| Urologie-Instrumente .....         | 259           |
| <b>Z</b>                           |               |
| <b>Zaufal-Jansen</b>               |               |
| Hohlmeißelzangen .....             | 346           |





|   |                |  |
|---|----------------|--|
| <b>A</b>  |                |  |
| Abdominal retractors .....                      | 183-194        |  |
| plaster saw .....                               | 233            |  |
| <b>Adson</b>                                    |                |  |
| Atrauma forceps .....                           | 117            |  |
| Cannulas .....                                  | 198            |  |
| Delicate tissue forceps ....                    | 78, 79, 89, 90 |  |
| Fine Wound Retractors .....                     | 148            |  |
| Hemostatic forceps .....                        | 120            |  |
| Micro suture forceps .....                      | 73             |  |
| Raspatories .....                               | 321            |  |
| Self-retaining retractors .....                 | 181            |  |
| Suture forceps .....                            | 216            |  |
| <b>Adson-Brown</b>                              |                |  |
| Skin forceps .....                              | 98             |  |
| <b>Adson-Ewald</b>                              |                |  |
| Delicate tissue forceps .....                   | 90, 98         |  |
| <b>Adson-Graefe</b>                             |                |  |
| Skin forceps .....                              | 98             |  |
| <b>Adson Standard</b>                           |                |  |
| Delicate dissecting forceps .....               | 78             |  |
| <b>Alderdyce</b>                                |                |  |
| Elevators .....                                 | 327            |  |
| <b>Alexander</b>                                |                |  |
| Chisels .....                                   | 307            |  |
| Gouges .....                                    | 307            |  |
| Raspatories .....                               | 320            |  |
| Uterine biopsy forceps .....                    | 293            |  |
| <b>Allen</b>                                    |                |  |
| Stomach clamps .....                            | 245            |  |
| <b>Allis</b>                                    |                |  |
| Intestinal and tissue<br>grasping forceps ..... | 236            |  |
| <b>Allis-Adair</b>                              |                |  |
| Intestinal and tissue<br>grasping forceps ..... | 237            |  |
| <b>Allis-Atrauma</b>                            |                |  |
| Intestinal and tissue<br>grasping forceps ..... | 237            |  |
| <b>Alm</b>                                      |                |  |
| Self-retaining retractors .....                 | 173            |  |
| Amniotome for the<br>amion bladder .....        | 280            |  |
| Amputation knives .....                         | 4-7            |  |
| Amputation retractor .....                      | 339            |  |
| Anal retractor .....                            | 235-252        |  |
| <b>Andrew-Pynchon</b>                           |                |  |
| Cannulas .....                                  | 197            |  |
| <b>Austin</b>                                   |                |  |
| Micro suture forceps .....                      | 73             |  |
| <b>Auvard</b>                                   |                |  |
| Vaginal specula .....                           | 276            |  |
| <b>B</b>  |                |  |
| <b>Babcock</b>                                  |                |  |
| Intestinal and tissue<br>grasping forceps ..... | 237            |  |
| <b>Babcock-Atrauma</b>                          |                |  |
| Intestinal and tissue<br>grasping forceps ..... | 239            |  |
| <b>Baby-Adson</b>                               |                |  |
| Hemostatic forceps .....                        | 120            |  |
| <b>Baby-Allis</b>                               |                |  |
| Intestinal and tissue<br>grasping forceps ..... | 236            |  |
| <b>Baby-Balfour</b>                             |                |  |
| Abdominal retractors .....                      | 187            |  |
| <b>Baby-Collin</b>                              |                |  |
| Abdominal retractors .....                      | 183            |  |
| <b>Baby-Crile</b>                               |                |  |
| Hemostatic forceps .....                        | 112            |  |
| <b>Baby-Doyen</b>                               |                |  |
| Intestinal clamps .....                         | 241            |  |
| <b>Baby-Kocher</b>                              |                |  |
| Intestinal clamps .....                         | 243            |  |
| <b>Baby-Lexer (Knapp)</b>                       |                |  |
| Face lift and nasal scissors .....              | 39             |  |
| <b>Baby-Metzenbaum</b>                          |                |  |
| Dissecting scissors .....                       | 34             |  |
| <b>Baby-Mikulicz</b>                            |                |  |
| Peritoneal forceps .....                        | 134            |  |
| <b>Baby-Mixer</b>                               |                |  |
| Ligature forceps .....                          | 129            |  |
| <b>Baby-Roux</b>                                |                |  |
| Retractors .....                                | 1 57           |  |
| <b>Baby-Senn-Mueller</b>                        |                |  |
| Retractors .....                                | 1 57           |  |
| <b>Baby-Tischler</b>                            |                |  |
| Biopsy forceps .....                            | 293            |  |
| <b>Backhaus</b>                                 |                |  |
| Towel forceps .....                             | 137            |  |
| <b>Bainbridge</b>                               |                |  |
| Hemostatic forceps .....                        | 120            |  |
| <b>Bakes</b>                                    |                |  |
| Gall duct instruments .....                     | 225            |  |
| <b>Balfour</b>                                  |                |  |
| Abdominal retractors .....                      | 187-189        |  |
| <b>Balfour USA-Modell</b>                       |                |  |
| Abdominal retractors .....                      | 189            |  |
| <b>Ballentine</b>                               |                |  |
| Hysterectomy forceps .....                      | 288            |  |
| <b>Bane-Hartmann</b>                            |                |  |
| Bone rongeur forceps .....                      | 342            |  |
| <b>Barnes-Neville</b>                           |                |  |
| Obstetrical forceps .....                       | 302            |  |
| <b>Baron</b>                                    |                |  |
| Cannulas .....                                  | 198            |  |
| <b>Barr</b>                                     |                |  |
| Rectal specula .....                            | 250            |  |
| <b>Barraquer</b>                                |                |  |
| Cilia forceps .....                             | 103            |  |
| Micro suture forceps .....                      | 210-211        |  |
| <b>Barraquer-Troutman</b>                       |                |  |
| Micro suture forceps .....                      | 211            |  |
| <b>Barrett</b>                                  |                |  |
| Uterine tenaculum forceps .....                 | 279            |  |
| <b>Beacham</b>                                  |                |  |
| Amniotome .....                                 | 280            |  |
| <b>Beebee</b>                                   |                |  |
| Crown Scissors .....                            | 61             |  |
| <b>Beer</b>                                     |                |  |
| Cilia forceps .....                             | 103            |  |
| <b>Bengolea</b>                                 |                |  |
| Hemostatic forceps .....                        | 121            |  |
| <b>Bennett</b>                                  |                |  |
| Bone levers .....                               | 331            |  |
| <b>Bergmann</b>                                 |                |  |
| Bandage scissors .....                          | 66             |  |
| Mallets .....                                   | 67             |  |
| Wound retractors .....                          | 152            |  |
| <b>Bernhard</b>                                 |                |  |
| Towel forceps .....                             | 136            |  |
| <b>Beyer</b>                                    |                |  |
| Bone rongeur forceps .....                      | 346            |  |
| <b>Biemer</b>                                   |                |  |
| Vein scissors .....                             | 16             |  |
| <b>Bircher-Ganske</b>                           |                |  |
| Bone holding forceps .....                      | 336            |  |
| <b>Birkett</b>                                  |                |  |
| Hemostatic forceps .....                        | 122            |  |
| <b>Blake</b>                                    |                |  |
| Call duct forceps .....                         | 254            |  |
| Uterine curettes .....                          | 295            |  |
| <b>Blount</b>                                   |                |  |
| Bone levers .....                               | 331            |  |
| <b>Blumenthal</b>                               |                |  |
| Bone rongeur forceps .....                      | 344            |  |
| <b>Böhler</b>                                   |                |  |
| Bone cutting forceps .....                      | 350            |  |
| Bone rongeur forceps .....                      | 345            |  |
| Extension bows .....                            | 365            |  |
| <b>Bonney</b>                                   |                |  |
| Dissecting forceps .....                        | 85             |  |
| Tissue forceps .....                            | 97             |  |
| <b>Böttcher</b>                                 |                |  |
| Tonsil scissors .....                           | 51             |  |
| <b>Boys-Allis</b>                               |                |  |
| Intestinal and tissue<br>grasping forceps ..... | 237            |  |
| <b>Bozemann</b>                                 |                |  |
| Cotton swab forceps .....                       | 141-142        |  |
| Suture forceps .....                            | 218            |  |
| <b>Bozemann-Douglas</b>                         |                |  |
| Cotton swab forceps .....                       | 142            |  |
| <b>Brand</b>                                    |                |  |
| Tendon seizing forceps .....                    | 370            |  |
| <b>Braun</b>                                    |                |  |
| Uterine depressor .....                         | 278            |  |
| Uterine tenaculum forceps ....                  | 279, 280       |  |
| <b>Braun-Stadler</b>                            |                |  |
| Perineum (Episiotomy) scissors .....            | 59             |  |
| <b>Breisky</b>                                  |                |  |
| Vaginal specula .....                           | 274            |  |
| <b>Bristow</b>                                  |                |  |
| Bone levers .....                               | 202            |  |
| <b>Brodie</b>                                   |                |  |
| Rectal probes .....                             | 202            |  |
| <b>Brophy</b>                                   |                |  |
| Delicate dissecting forceps .....               | 82             |  |
| Delicate tissue forceps .....                   | 93             |  |
| <b>Brophy (Sullivan)</b>                        |                |  |
| Delicate surgical scissors .....                | 24             |  |
| <b>Brown</b>                                    |                |  |
| Skin forceps .....                              | 98             |  |
| Suture forceps .....                            | 212            |  |
| <b>Brunner</b>                                  |                |  |
| Guiding probes .....                            | 228            |  |
| Retractors .....                                | 167, 170       |  |
| Sigmoid anastomosis clamps .....                | 248            |  |
| <b>Brunner-Ferrozell</b>                        |                |  |
| Guiding probes .....                            | 228            |  |
| <b>Bruns</b>                                    |                |  |
| Bandage scissors .....                          | 66-37          |  |
| Bone curettes .....                             | 313-314        |  |
| <b>Buie</b>                                     |                |  |
| Clamp forceps .....                             | 133            |  |
| <b>Bunt</b>                                     |                |  |
| Sterilization clamps .....                      | 372            |  |
| <b>Busch</b>                                    |                |  |
| Umbilical scissors .....                        | 58             |  |
| <b>C</b>  |                |  |
| <b>Carrel</b>                                   |                |  |
| Hemostatic forceps .....                        | 117            |  |
| <b>Caspar</b>                                   |                |  |
| Retractors .....                                | 163            |  |



**Castanares**  
Dissecting scissors ..... 41

**Castroviejo**  
Corneal scissors ..... 14-15  
Micro spring scissors ..... 14  
Micro suture forceps ..... 209-211  
Razor blade holder ..... 6

**Castroviejo/Barraquer**  
Micro suture forceps ..... 210

**Castroviejo-Kalt**  
Micro suture forceps ..... 211

**Chaput**  
Hemostatic forceps ..... 117

**Charrière**  
Saws ..... 354

**Cheron**  
Cotton swab forceps ..... 141

**Cleveland**  
Bone rongeur forceps ..... 343

**Cloward**  
Self-retaining retractors ..... 176

**Cobb**  
Raspatories ..... 323-324

**Coller-Crile**  
Hemostatic forceps ..... 113

**Collin**  
Abdominal retractors ..... 183-185  
Cotton swab forceps ..... 141  
Obstetrics ..... 300  
Retractors ..... 159  
Rib shears ..... 70  
Sponge holding forrsept ..... 143  
Tissue grasping forceps ..... 118  
Uterine elevating forceps ..... 284  
Vaginal specula ..... 264

**Collin-Duval**  
Intestinal and lung forceps ..... 99

**Collin-Pozzi**  
Uterine tenaculum forceps ..... 279

**Cone**  
Self-retaining retractors ..... 182

**Cone (Adson-Baby)**  
Self-retaining retractors ..... 179

**Converse**  
Suture forceps ..... 221

**Cooley**  
Retractors ..... 227

**Cooper**  
Ligature needles ..... 227

**Cottle**  
Chisels ..... 308  
Ear dressing forceps ..... 87  
Mallets ..... 368  
Nasal scissors ..... 43  
Osteotomes ..... 308  
Raspatories ..... 321  
Skin forceps ..... 44

**Crile**  
Fine wound retractors ..... 148  
Hemostatic forceps ..... 112  
Retractors ..... 155

**Crile-Murray**  
Suture forceps ..... 214

**Crile-Rankin**  
Hemostatic forceps ..... 112

**Crile-Wood**  
Suture forceps ..... 214, 219, 220

**Cusco**  
Vaginal specula ..... 345-346

**Cushing**  
Delicate dissecting forceps ..... 82  
Delicate tissue forceps ..... 92  
Fine wound retractors ..... 148  
Raspatories ..... 319  
Retractors ..... 154-156

**Cushing-Taylor**  
Delicate dissecting forceps ..... 81

**Czerny**  
Rectal specula ..... 249  
Uterine tenaculum forceps ..... 280

**D**

**Dandy**  
Hemostatic forceps ..... 119

**Daubenspeck**  
Bone curettes ..... 315

**Davidson**  
Retractors ..... 171

**Dean**  
Gum scissors ..... 62

**Deaver**  
Retractors ..... 167-168  
Surgical scissors ..... 26

**De Bakey**  
Atrauma forceps ..... 86  
Suture forceps ..... 220  
Vascular scissors ..... 48

**Demel**  
Bone wire guides ..... 366

**Denis-Brown**  
Abdominal retractors ..... 192

**Derf**  
Suture forceps ..... 212, 217

**Deschamps**  
Ligature needles ..... 229

**Deschamps-Standard**  
Ligature needles ..... 225

**Desjardins**  
Gall duct forceps ..... 254  
Gall stone forceps ..... 254

**Desmarres**  
Retractors ..... 155

**Dieffenbach**  
Bulldog clamps ..... 145

**Diethrich**  
Bulldog clamps ..... 146

**Dingmann**  
Bone holding forceps ..... 335

**Dixon-Lovelace**  
Hemostatic forceps ..... 119

**Douglas**  
Cilia forceps ..... 103

**Doyen**  
Abdominal retractors ..... 193  
Gynecological scissors ..... 57  
Intestinal clamps ..... 241  
Myoma screw ..... 285  
Probes ..... 201  
Raspatories ..... 322  
Retractors ..... 165  
Vaginal specula ..... 273-275

**Doyen-Atrauma**  
Intestinal clamps ..... 242

**Dratigues**  
Uterine elevating forceps ..... 284

**Duplay**  
Uterine tenaculum forceps ..... 279

**E**

**Emmet**  
Cotton swab forceps ..... 141

**Engel**  
Plaster saw ..... 233

**Engl. Modell**  
Towel forceps ..... 136

**Eppendorf**  
Biopsy forceps ..... 293

**Errico**  
Cutter ..... 355

**Esmarch**  
Bandage scissors ..... 62  
Plaster knife ..... 233

**Ewald**  
Delicate dissecting forceps ..... 78

**F**

**Farabeuf**  
Raspatories ..... 319  
Retractors ..... 159

**Farabeuf-Lambotte**  
Bone holding forceps ..... 339

**Farrell**  
Cotton applicators ..... 204

**Faure**  
Biopsy forceps ..... 292  
Peritoneal forceps ..... 135

**Fehland**  
Sigmoid anastomosis clamps ..... 248

**Feilchenfeld**  
Splinter forceps ..... 101

**Fein**  
Cotton applicators ..... 204

**Ferguson**  
Bone holding forceps ..... 337  
Haemorrhoidal forceps ..... 253  
Surgical scissors ..... 26

**Ferris-Smith**  
Tissue forceps ..... 96

**Finocchietto**  
Ligature forceps ..... 131  
Suture forceps ..... 215, 223

**Finsen**  
Self-retaining retractors ..... 173

**Fomon**  
Nasal scissors ..... 43-44

**Förster-Ballenger**  
Sponge holding forceps ..... 183

**Frazier**  
Cannulas ..... 198

**Freeman-Gorney**  
Dissecting scissors ..... 40

**Freeman-Kaye**  
Dissecting scissors ..... 48

**Fritsch**  
Retractors ..... 165

**G**

Gall duct forceps ..... 254  
Gall duct instruments ..... 255  
Gall stone forceps ..... 333

**Gemini**  
Ligature forceps ..... 127

**Gerald**  
Delicate dissecting forceps ..... 80  
Delicate Tissue Forceps ..... 93



|  |          |     |
|--|----------|-----|
| <b>Gillies</b>                               |          |     |
| Delicate tissue forceps .....                | 91       |     |
| Skin hooks .....                             | 149      |     |
| Suture forceps .....                         | 211, 216 |     |
| <b>Gil-Vernet</b>                            |          |     |
| Wound retractors .....                       | 150      |     |
| <b>Gluck</b>                                 |          |     |
| Rib shears .....                             | 70       |     |
| <b>Goelet</b>                                |          |     |
| Retractors .....                             | 158      |     |
| <b>Goldmann-Fox</b>                          |          |     |
| Delicate dissecting scissors .....           | 28       |     |
| <b>Goldmann-Fox (spezial)</b>                |          |     |
| Delicate dissecting scissors .....           | 28-29    |     |
| <b>Good</b>                                  |          |     |
| Tonsil scissors .....                        | 52       |     |
| <b>Gorney</b>                                |          |     |
| Dissecting scissors .....                    | 40       |     |
| <b>Gosset</b>                                |          |     |
| Abdominal retractors .....                   | 186      |     |
| <b>Gourdet</b>                               |          |     |
| Uterine curettes .....                       | 296      |     |
| <b>Graefe</b>                                |          |     |
| Delicate dissecting scissors .....           | 79       |     |
| Delicate Tissue forceps .....                | 89       |     |
| Skin hooks .....                             | 149      |     |
| <b>Grave</b>                                 |          |     |
| Vaginal specula .....                        | 265      |     |
| <b>Green</b>                                 |          |     |
| Retractors .....                             | 164      |     |
| <b>Green-Armytage</b>                        |          |     |
| Uterine forceps .....                        | 304      |     |
| <b>Gross-Maier</b>                           |          |     |
| Dressing forceps .....                       | 140      |     |
| <b>Grünwald</b>                              |          |     |
| Delicate dissecting forceps .....            | 83       |     |
| <b>Guthrie</b>                               |          |     |
| Skin hooks .....                             | 149      |     |
| <b>Guttman</b>                               |          |     |
| Secretion spoons .....                       | 262      |     |
| Uterine secretion spoon .....                | 285      |     |
| <b>Guyon</b>                                 |          |     |
| Catheter guide .....                         | 262      |     |
| Kidney clamps .....                          | 256      |     |
| <b>Guyon-Atrauma</b>                         |          |     |
| Kidney clamps .....                          | 256      |     |
| <b>H</b>                                     |          |     |
| <b>Haberer</b>                               |          |     |
| Spatulas .....                               | 172      |     |
| <b>Hajek</b>                                 |          |     |
| Mallets .....                                | 368      |     |
| <b>Hakansson</b>                             |          |     |
| Bone rongeur forceps .....                   | 345      |     |
| <b>Halle</b>                                 |          |     |
| Nasal scissors .....                         | 316      |     |
| <b>Halsey</b>                                |          |     |
| Suture forceps .....                         | 212, 221 |     |
| <b>Halsted-Mosquito</b>                      |          |     |
| Hemostatic forceps .....                     | 114, 115 |     |
| <b>Harrington</b>                            |          |     |
| Retractors .....                             | 169      |     |
| <b>Hartmann</b>                              |          |     |
| Bone rongeur forceps .....                   | 117      |     |
| Hemostatic forceps .....                     | 343      |     |
| <b>Harvey</b>                                |          |     |
| Bandage scissors .....                       | 64       |     |
| <b>Heaney</b>                                |          |     |
| Parametrium forceps .....                    | 287      |     |
| Retractors .....                             | 169      |     |
| Suture forceps .....                         | 213      |     |
| <b>Heaney-Ballentine</b>                     |          |     |
| Hysterectomy forceps .....                   | 288      |     |
| <b>Heaney-Slim</b>                           |          |     |
| Parametrium forceps .....                    | 287      |     |
| <b>Heath</b>                                 |          |     |
| Mallets .....                                | 267      |     |
| <b>Hegar</b>                                 |          |     |
| Suture forceps .....                         | 214      |     |
| Uterine dilators .....                       | 277      |     |
| <b>Hegar-Baumgartner</b>                     |          |     |
| Suture forceps .....                         | 212, 219 |     |
| <b>Hegar-Vascular</b>                        |          |     |
| Suture forceps .....                         | 222      |     |
| <b>Hegemann-Diethrich</b>                    |          |     |
| Vascular scissors .....                      | 48,49    |     |
| <b>Hegenbarth</b>                            |          |     |
| Clip applying forceps .....                  | 230      |     |
| <b>Heiss</b>                                 |          |     |
| Ligature forceps .....                       | 128      |     |
| Self-retaining retractors .....              | 173      |     |
| <b>Henley</b>                                |          |     |
| Self-retaining retractors .....              | 177, 178 |     |
| <b>Henning</b>                               |          |     |
| Plaster spreader .....                       | 233      |     |
| <b>Heymann</b>                               |          |     |
| Nasal scissors .....                         | 42       |     |
| <b>Heywood-Smith</b>                         |          |     |
| Haemorrhoidal forceps .....                  | 253      |     |
| Polypus- and ovary forceps .....             | 283      |     |
| <b>Hibbs</b>                                 |          |     |
| Chisels .....                                | 311      |     |
| Gouges .....                                 | 311      |     |
| Osteotomes .....                             | 311      |     |
| Retractors .....                             | 170      |     |
| <b>Hoer</b>                                  |          |     |
| Raspatories .....                            | 325      |     |
| <b>Hohmann</b>                               |          |     |
| Bone levers .....                            | 329, 330 |     |
| <b>Hohmann-Aldinger</b>                      |          |     |
| Bone levers .....                            | 330      |     |
| <b>Hoke</b>                                  |          |     |
| Osteotomes .....                             | 307      |     |
| <b>Hopkins</b>                               |          |     |
| Plaster knife .....                          | 233      |     |
| <b>Hösel</b>                                 |          |     |
| Retractors .....                             | 166      |     |
| Vaginal retractors .....                     | 275      |     |
| <b>Hudson</b>                                |          |     |
| Cutter .....                                 | 355      |     |
| Drills .....                                 | 355      |     |
| Handle .....                                 | 355      |     |
| <b>Hunter</b>                                |          |     |
| Splinter forceps .....                       | 101      |     |
| <b>I</b>                                     |          |     |
| Instrument box .....                         |          | 375 |
| Instrument trays .....                       |          | 375 |
| Iris scissors .....                          |          | 19  |
| <b>Israel</b>                                |          |     |
| Retractors .....                             | 160      |     |
| <b>Iterson</b>                               |          |     |
| Wound retractors .....                       | 153      |     |
| <b>Ives-Fansler</b>                          |          |     |
| Anusscopes .....                             | 251      |     |
| <b>J</b>                                     |          |     |
| <b>Jackson</b>                               |          |     |
| Vaginal specula .....                        | 268      |     |
| Wound retractors .....                       | 150, 152 |     |
| <b>Jacobs</b>                                |          |     |
| Uterine tenaculum forceps .....              | 282      |     |
| <b>Jacobson</b>                              |          |     |
| Hemostatic forceps .....                     | 114      |     |
| Micro spring scissors .....                  | 17       |     |
| Micro suture forceps .....                   | 208      |     |
| <b>Jacobson-Adson</b>                        |          |     |
| Delicate dissecting forceps .....            | 78       |     |
| <b>Jameson</b>                               |          |     |
| Suture forceps .....                         | 216      |     |
| <b>Jansen</b>                                |          |     |
| Bone curettes .....                          | 317      |     |
| Bone rongeur forceps .....                   | 343-346  |     |
| Ear dressing forceps .....                   | 118      |     |
| Raspatories .....                            | 320      |     |
| Self-retaining retractors .....              | 173      |     |
| <b>Jansen-Gruenwald</b>                      |          |     |
| Ear dressing forceps .....                   | 87       |     |
| <b>Jobson-Horne</b>                          |          |     |
| Cotton applicators .....                     | 204      |     |
| <b>Johns-Hopkins</b>                         |          |     |
| Bulldog clamps .....                         | 145      |     |
| Ligature forceps .....                       | 123      |     |
| <b>Joll (Friedmann)</b>                      |          |     |
| Thyroid- and vaginal retractors .....        | 182      |     |
| <b>Jones</b>                                 |          |     |
| Towel forceps .....                          | 136      |     |
| <b>Jorgensen</b>                             |          |     |
| Vascular scissors .....                      | 46       |     |
| <b>Joseph</b>                                |          |     |
| Dissecting scissors .....                    | 39       |     |
| Raspatories .....                            | 321      |     |
| <b>Judd-Allis</b>                            |          |     |
| Intestinal and tissue grasping forceps ..... | 238      |     |
| <b>Judd-Masson</b>                           |          |     |
| Bladder retractors .....                     | 258      |     |
| <b>K</b>                                     |          |     |
| <b>Kallmorgen</b>                            |          |     |
| Vaginal specula sets .....                   | 267      |     |
| <b>Kalt</b>                                  |          |     |
| Micro suture forceps .....                   | 211      |     |
| <b>Kantrowitz</b>                            |          |     |
| Ligature forceps .....                       | 123      |     |
| <b>Kazanjan</b>                              |          |     |
| Bone cutting forceps .....                   | 351      |     |
| <b>Kelly</b>                                 |          |     |
| Fistula scissors .....                       | 56       |     |
| Hemostatic forceps .....                     | 110      |     |
| Polypus- and ovary forceps .....             | 283      |     |
| Proctoscopes .....                           | 251      |     |
| Retractors .....                             | 166, 171 |     |
| <b>Kelly-Rankin</b>                          |          |     |
| Hemostatic forceps .....                     | 110      |     |
| <b>Kern</b>                                  |          |     |
| Bone holding forceps .....                   | 337      |     |
| <b>Kevorkian</b>                             |          |     |
| Biopsy forceps .....                         | 293      |     |
| <b>Kielland</b>                              |          |     |
| Obstetrical forceps .....                    | 302      |     |
| <b>Kilner</b>                                |          |     |
| Dissecting scissors .....                    | 40       |     |
| Nasal scissors .....                         | 42       |     |
| Skin hooks .....                             | 148      |     |
| Suture forceps .....                         | 221      |     |





|  |               |  |  |
|--|---------------|--|--|
| <b>Kirschner</b>                             |               |  |  |
| Abdominal retractors .....                   | 191           |  |  |
| <b>Klapp</b>                                 |               |  |  |
| Tendon sheath hooks .....                    | 369           |  |  |
| <b>Kleinert-Kutz</b>                         |               |  |  |
| Fine wound retractors .....                  | 149           |  |  |
| Tendon passing forceps .....                 | 370           |  |  |
| <b>Kleinschmidt</b>                          |               |  |  |
| Appendectomy clamps .....                    | 245           |  |  |
| <b>Klima-Rosegger</b>                        |               |  |  |
| Sternal puncture needles .....               | 197           |  |  |
| <b>Klingenberg-Loth</b>                      |               |  |  |
| Vascular scissors .....                      | 47            |  |  |
| <b>Knapp</b>                                 |               |  |  |
| Eye scissors .....                           | 18            |  |  |
| Wound retractors .....                       | 52            |  |  |
| <b>Knowles</b>                               |               |  |  |
| Bandage scissors .....                       |               |  |  |
| <b>Kocher</b>                                |               |  |  |
| Bone Retractors .....                        | 333           |  |  |
| Hemostatic forceps .....                     | 111           |  |  |
| Intestinal clamps .....                      | 244           |  |  |
| Retractors .....                             | 162, 163, 166 |  |  |
| <b>Kocher-Atrauma</b>                        |               |  |  |
| Intestinal clamps .....                      | 244           |  |  |
| <b>Kocher-Langenbeck</b>                     |               |  |  |
| Retractors .....                             | 163           |  |  |
| <b>König</b>                                 |               |  |  |
| Elevators .....                              | 327           |  |  |
| Guiding probes .....                         | 229           |  |  |
| <b>Körte</b>                                 |               |  |  |
| Retractors .....                             | 160           |  |  |
| <b>Kristeller</b>                            |               |  |  |
| Vaginal specula sets .....                   | 268-271       |  |  |
| <b>Kronecker</b>                             |               |  |  |
| Ligature needles .....                       | 225           |  |  |
| <b>Kuehne</b>                                |               |  |  |
| Cilia forceps .....                          | 104           |  |  |
| <b>L</b>                                     |               |  |  |
| <b>La Grange</b>                             |               |  |  |
| Gum scissors .....                           | 62            |  |  |
| <b>Lahey</b>                                 |               |  |  |
| Ligature forceps .....                       | 131           |  |  |
| Retractors .....                             | 161           |  |  |
| <b>Lambotte</b>                              |               |  |  |
| Bone holding forceps .....                   | 339           |  |  |
| Osteotomes .....                             | 309           |  |  |
| Raspatories .....                            | 320           |  |  |
| <b>Landolt</b>                               |               |  |  |
| Enucleation scissors .....                   | 30            |  |  |
| <b>Lane</b>                                  |               |  |  |
| Bone holding forceps .....                   | 340, 336      |  |  |
| Stomach and intestinal twin clamps .....     | 247           |  |  |
| Towel forceps .....                          | 136           |  |  |
| <b>Lane-Trethowan</b>                        |               |  |  |
| Bone levers .....                            | 330           |  |  |
| <b>Langenbeck</b>                            |               |  |  |
| Bone holding forceps .....                   | 336           |  |  |
| Elevators .....                              | 325           |  |  |
| Raspatories .....                            | 319           |  |  |
| Resection knives .....                       | 8             |  |  |
| Retractors .....                             | 160-162       |  |  |
| Saws .....                                   | 353           |  |  |
| <b>Lawrence</b>                              |               |  |  |
| Ligature forceps .....                       | 131           |  |  |
| <b>Lazar</b>                                 |               |  |  |
| Micro suture forceps .....                   | 73            |  |  |
| <b>Leksell</b>                               |               |  |  |
| Bone rongeur forceps .....                   | 349           |  |  |
| <b>Lempert</b>                               |               |  |  |
| Bone rongeur forceps .....                   | 344           |  |  |
| <b>Leriche</b>                               |               |  |  |
| Hemostatic forceps .....                     | 113           |  |  |
| <b>Lewin</b>                                 |               |  |  |
| Bone holding forceps .....                   | 336           |  |  |
| <b>Lexer</b>                                 |               |  |  |
| Gouges .....                                 | 310, 312      |  |  |
| Osteotomes .....                             | 310           |  |  |
| <b>Lexer-Fino</b>                            |               |  |  |
| Dissecting scissors .....                    | 30            |  |  |
| Ligature forceps .....                       | 123, 132      |  |  |
| <b>Lister</b>                                |               |  |  |
| Bandage scissors .....                       | 64, 65        |  |  |
| Sinus forceps .....                          | 139           |  |  |
| <b>Lister-Excentric</b>                      |               |  |  |
| Bandage scissors .....                       | 65            |  |  |
| <b>Liston</b>                                |               |  |  |
| Amputation knives .....                      | 7             |  |  |
| Bone cutting forceps .....                   | 350           |  |  |
| <b>Liston-Key-Horsley</b>                    |               |  |  |
| Bone cutting forceps .....                   | 351           |  |  |
| <b>Littauer</b>                              |               |  |  |
| Ligature scissors .....                      | 54            |  |  |
| <b>Littler</b>                               |               |  |  |
| Dissecting scissors with suture holes .....  | 54            |  |  |
| <b>Littlewood</b>                            |               |  |  |
| Intestinal and tissue grasping forceps ..... | 238           |  |  |
| <b>Lockart-Mummary</b>                       |               |  |  |
| Fistula probes .....                         | 203           |  |  |
| <b>Locklin</b>                               |               |  |  |
| Gum scissors .....                           | 62            |  |  |
| <b>Lockwood</b>                              |               |  |  |
| Intestinal and tissue grasping forceps ..... | 238           |  |  |
| <b>Lorenz</b>                                |               |  |  |
| Bandage scissors .....                       | 66            |  |  |
| <b>Lorna</b>                                 |               |  |  |
| Towel forceps .....                          | 137           |  |  |
| <b>Loute</b>                                 |               |  |  |
| Bone wire tighteners .....                   | 366           |  |  |
| <b>Lower</b>                                 |               |  |  |
| Gall duct clamp forceps .....                | 127           |  |  |
| <b>Lowman</b>                                |               |  |  |
| Bone holding forceps .....                   | 341           |  |  |
| <b>Lucae</b>                                 |               |  |  |
| Ear dressing forceps .....                   | 368           |  |  |
| Mallets .....                                | 87            |  |  |
| <b>Lucas</b>                                 |               |  |  |
| Chisels .....                                | 306           |  |  |
| Gouges .....                                 | 306           |  |  |
| <b>Luer</b>                                  |               |  |  |
| Bone rongeur forceps .....                   | 342, 345      |  |  |
| Retractors .....                             | 155           |  |  |
| <b>Luer-Friedmann</b>                        |               |  |  |
| Bone rongeur forceps .....                   | 342           |  |  |
| <b>Luer-Koerte</b>                           |               |  |  |
| Gall duct instruments .....                  | 255           |  |  |
| <b>M</b>                                     |               |  |  |
| <b>Magill</b>                                |               |  |  |
| Catheter forceps .....                       | 199           |  |  |
| <b>Marquardt</b>                             |               |  |  |
| Bone rongeur forceps .....                   | 347           |  |  |
| <b>Martin</b>                                |               |  |  |
| Bone holding forceps .....                   | 335           |  |  |
| Retractors .....                             | 167           |  |  |
| <b>Martin-Cartilage</b>                      |               |  |  |
| Cartilage scissors .....                     | 46            |  |  |
| <b>Martini</b>                               |               |  |  |
| Bone curettes .....                          | 314           |  |  |
| <b>Martin (Simpson)</b>                      |               |  |  |
| Uterine probes .....                         | 278           |  |  |
| <b>Masson</b>                                |               |  |  |
| Suture forceps .....                         | 215, 223      |  |  |
| <b>Mathieu</b>                               |               |  |  |
| Rectal specula .....                         | 250           |  |  |
| Retractors .....                             | 159           |  |  |
| Suture Forceps .....                         | 217, 224      |  |  |
| Vaginal spekula .....                        | 273           |  |  |
| <b>Mayfield</b>                              |               |  |  |
| Bone rongeur forceps .....                   | 346           |  |  |
| <b>Mayo</b>                                  |               |  |  |
| Dissecting scissors .....                    | 31, 32        |  |  |
| Grasping forceps .....                       | 100           |  |  |
| Sterilization clamps .....                   | 372           |  |  |
| <b>Mayo-Adams</b>                            |               |  |  |
| Self-retaining retractors .....              | 176-178       |  |  |
| <b>Mayo-Hegar</b>                            |               |  |  |
| Suture forceps .....                         | 213, 218, 219 |  |  |
| <b>Mayo-Noble</b>                            |               |  |  |
| Dissecting scissors .....                    | 34            |  |  |
| <b>Mayo-Robson</b>                           |               |  |  |
| Intestinal clamps .....                      | 243           |  |  |
| <b>Mayo-Robson Atrauma</b>                   |               |  |  |
| Intestinal clamps .....                      | 343           |  |  |
| <b>Mayo-Stille</b>                           |               |  |  |
| Dissecting scissors .....                    | 33            |  |  |
| <b>Mc Donald</b>                             |               |  |  |
| Elevators .....                              | 327           |  |  |
| <b>Mc Givney</b>                             |               |  |  |
| Haemorrhoidal forceps .....                  | 253           |  |  |
| <b>Mc Indoe</b>                              |               |  |  |
| Bone cutting forceps .....                   | 350           |  |  |
| Delicate dissecting forceps .....            | 79            |  |  |
| Delicate tissue forceps .....                | 91            |  |  |
| Vascular scissors .....                      | 46            |  |  |
| <b>Mc Kenzil</b>                             |               |  |  |
| Cutter .....                                 | 355           |  |  |
| <b>Mead</b>                                  |               |  |  |
| Bone rongeur forceps .....                   | 368           |  |  |
| Mallets .....                                | 368           |  |  |
| <b>Meeker</b>                                |               |  |  |
| Ligature forceps .....                       | 127           |  |  |
| <b>Metzenbaum</b>                            |               |  |  |
| Dissecting scissors .....                    | 35-38         |  |  |
| <b>Metzenbaum-Fino</b>                       |               |  |  |
| Dissecting scissors .....                    | 35-37         |  |  |
| <b>Metzenbaum-S</b>                          |               |  |  |
| Dissecting scissors .....                    | 38            |  |  |
| <b>Meyerding</b>                             |               |  |  |
| Retractors .....                             | 169           |  |  |
| <b>Michel</b>                                |               |  |  |
| Clip applying and removing forceps .....     | 230           |  |  |
| Clip applying forceps .....                  | 230           |  |  |
| <b>Michel Mod.</b>                           |               |  |  |
| Clip applying and removing forceps .....     | 230           |  |  |
| <b>Micro Adson</b>                           |               |  |  |
| Delicate dissecting forceps .....            | 78            |  |  |
| Delicate tissue forceps .....                | 89            |  |  |



## Alphabetisches Inhaltsverzeichnis Alphabetical Index

|                                     |         |
|-------------------------------------|---------|
| <b>Micro-Mosquito</b>               |         |
| Hemostatic forceps .....            | 116     |
| <b>Micro-Ryder</b>                  |         |
| Suture forceps .....                | 222     |
| <b>Micro-Semken</b>                 |         |
| Delicate tissue forceps .....       | 90      |
| <b>Middeldorpf</b>                  |         |
| Retractors .....                    | 164     |
| <b>Mikulicz</b>                     |         |
| Peritoneal forceps .....            | 134-135 |
| Retractors .....                    | 170,171 |
| <b>Miller</b>                       |         |
| Bone rasps .....                    | 318     |
| <b>Millin</b>                       |         |
| Bladder neck spreader .....         | 260     |
| <b>Mini-Friedmann</b>               |         |
| Bone rongeur forceps .....          | 342     |
| <b>Mini-Gemini</b>                  |         |
| Ligature forceps .....              | 129     |
| <b>Mini-Hohmann</b>                 |         |
| Bone levers .....                   | 328     |
| <b>Mini-Lambotte</b>                |         |
| Osteotomes .....                    | 309     |
| <b>Mini-Langenbeck</b>              |         |
| Wound retractors .....              | 150     |
| <b>Mini-Lexer</b>                   |         |
| Gouges .....                        | 310     |
| Osteotomes .....                    | 310     |
| <b>Mini-Lowman</b>                  |         |
| Bone holding forceps .....          | 341     |
| <b>Mixer</b>                        |         |
| Ligature forceps .....              | 130     |
| <b>Mod. Bonn</b>                    |         |
| Delicate dissecting scissors .....  | 27      |
| <b>Modell USA</b>                   |         |
| Dissecting forceps .....            | 85      |
| Tissue forceps .....                | 96      |
| Plaster spreader .....              | 234     |
| Umbilical scissors .....            | 58      |
| <b>Mod. Wien</b>                    |         |
| Suture hook .....                   | 229     |
| <b>Mollison</b>                     |         |
| Self-retaining retractors .....     | 175-176 |
| <b>Morris</b>                       |         |
| Retractors .....                    | 164     |
| <b>Murphy-Lane</b>                  |         |
| Bone levers .....                   | 331     |
| <b>Museum</b>                       |         |
| Uterine tenaculum forceps .....     | 238-283 |
| <br>                                |         |
| <b>N</b>                            |         |
| <b>Nägele</b>                       |         |
| Obstetrical forceps .....           | 302     |
| <b>Negus</b>                        |         |
| .....                               | 33      |
| <b>Neivert</b>                      |         |
| Suture forceps .....                | 217     |
| <b>Nelaton</b>                      |         |
| Directors .....                     | 202     |
| <b>Nelson</b>                       |         |
| Intestinal and lung forceps .....   | 99      |
| <b>New Orleans</b>                  |         |
| Suture forceps .....                | 212     |
| <b>News</b>                         |         |
| Trachea retractors .....            | 150     |
| <b>Northbent</b>                    |         |
| Ligature scissors .....             | 54      |
| <br>                                |         |
| <b>Noto</b>                         |         |
| Polypus- and ovary forceps .....    | 283     |
| <b>Novak</b>                        |         |
| Biopsy instruments .....            | 290     |
| <b>Noyes</b>                        |         |
| Iridectomy scissors .....           | 13      |
| <br>                                |         |
| <b>O</b>                            |         |
| <b>Ochsner-Kocher</b>               |         |
| Hemostatic forceps .....            | 108-110 |
| <b>O'Connor</b>                     |         |
| Fine wound retractors .....         | 149     |
| <b>Oehler</b>                       |         |
| Delicate tissue forceps .....       | 92      |
| <b>Ollier</b>                       |         |
| Retractors .....                    | 160     |
| <b>Olsen-Hegar</b>                  |         |
| Suture forceps .....                | 216     |
| <b>Ombredanne</b>                   |         |
| Mallets .....                       | 367     |
| <b>O'Sullivan-O'Connor</b>          |         |
| Abdominal retractors .....          | 193     |
| <b>Overholt-Geissendörfer</b>       |         |
| Ligature forceps .....              | 125     |
| <b>Overholt-Mixter</b>              |         |
| Ligature forceps .....              | 128     |
| <b>Overholt-S</b>                   |         |
| Ligature forceps .....              | 124     |
| <br>                                |         |
| <b>P</b>                            |         |
| <b>Parker</b>                       |         |
| Retractors .....                    | 158     |
| <b>Parker-Langenbeck</b>            |         |
| Retractors .....                    | 158     |
| <b>Parker-Mott</b>                  |         |
| Retractors .....                    | 158     |
| <b>Partsch</b>                      |         |
| Chisels .....                       | 307     |
| <b>Payr</b>                         |         |
| Guiding probes .....                | 228     |
| Intestinal and pylorus clamps ..... | 246     |
| <b>Pean</b>                         |         |
| Hemostatic forceps .....            | 111,117 |
| <b>Peck-Joseph</b>                  |         |
| Dissecting scissors .....           | 39      |
| <b>Peers-Bertram</b>                |         |
| Towel forceps .....                 | 137     |
| <b>Peet</b>                         |         |
| Splinter forceps .....              | 102     |
| <b>Pennington</b>                   |         |
| Tissue grasping forceps .....       | 118     |
| <b>Percy</b>                        |         |
| Amputation retractor .....          | 339     |
| <b>Perthes</b>                      |         |
| Awls .....                          | 358     |
| <b>Phaneuf</b>                      |         |
| Hysterectomy forceps .....          | 288     |
| <b>Piper</b>                        |         |
| Obstetrical forceps .....           | 302     |
| <b>Plester</b>                      |         |
| Self-retaining retractors .....     | 174     |
| <b>Poole</b>                        |         |
| Cannulas .....                      | 197     |
| <b>Potts-Smith</b>                  |         |
| Delicate dissecting forceps .....   | 83      |
| Delicate tissue forceps .....       | 92      |
| Vascular scissors .....             | 45-47   |
| <br>                                |         |
| <b>Pozzi</b>                        |         |
| Uterine tenaculum forceps .....     | 279     |
| <b>Pratt</b>                        |         |
| Fistula probes .....                | 203     |
| Haemorrhoidal forceps .....         | 282     |
| Rectal specula .....                | 253     |
| Uterine tenaculum forceps .....     | 248     |
| <b>Providence</b>                   |         |
| Hemostatic forceps .....            | 114     |
| <b>Putti</b>                        |         |
| Bone rasps .....                    | 318     |
| <br>                                |         |
| <b>Q</b>                            |         |
| <b>Quervain</b>                     |         |
| Elevators .....                     | 326     |
| <br>                                |         |
| <b>R</b>                            |         |
| <b>Radolf</b>                       |         |
| Nail pulling forceps .....          | 352     |
| <b>Ragnell-Davis</b>                |         |
| Retractors .....                    | 156     |
| <b>Ralk</b>                         |         |
| Splinter forceps .....              | 102     |
| <b>Ramplay</b>                      |         |
| Sponge holding forceps .....        | 114     |
| <b>Randall</b>                      |         |
| Biopsie instruments .....           | 290     |
| Kidney stone forceps .....          | 336     |
| <b>Recamier</b>                     |         |
| Uterine curettes .....              | 295-296 |
| <b>Redon</b>                        |         |
| Needles .....                       | 200     |
| <b>Reiner</b>                       |         |
| Plaster knife .....                 | 233     |
| <b>Resano</b>                       |         |
| Capsule scissors .....              | 46      |
| Sigmoid anastomosis clamps .....    | 248     |
| <b>Reverdin</b>                     |         |
| Needles .....                       | 227     |
| Spatulas .....                      | 172     |
| <b>Reynolds</b>                     |         |
| Delicate dissecting scissors .....  | 29      |
| Dissecting scissors .....           | 39      |
| <b>Ricard</b>                       |         |
| Abdominal retractors .....          | 185     |
| <b>Richardson</b>                   |         |
| Retractors .....                    | 165     |
| <b>Richardson-Eastman</b>           |         |
| Retractors .....                    | 165     |
| <b>Richter</b>                      |         |
| Surgical scissors .....             | 26      |
| <b>Richter-Heath</b>                |         |
| Clip forceps .....                  | 230     |
| <b>Roberts</b>                      |         |
| Hemostatic forceps .....            | 122     |
| <b>Rochard</b>                      |         |
| Abdominal retractors .....          | 194     |
| <b>Rochester-Carmalt</b>            |         |
| Hemostatic forceps .....            | 119     |
| <b>Rochester-Pean</b>               |         |
| Hemostatic forceps .....            | 106-107 |
| <b>Röttgen-Ruskin</b>               |         |
| Bone rongeur forceps .....          | 347     |
| <b>Roux</b>                         |         |
| Retractors .....                    | 157     |



**Rumel**  
Ligature forceps ..... 123  
Round Basins ..... 374  
Rundzange ..... 352

**Ruskin**  
Bone rongeur forceps ..... 346

**Ruskin-Liston**  
Bone cutting forceps ..... 351

**Russ. Modell**  
Grasping forceps ..... 100

**Ryder**  
Suture forceps ..... 222

**S**

Salpingograph ..... 298,299  
Saws ..... 353,354

**Sänger**  
Ovum forceps ..... 304

**Sanvenero**  
Delicate scissors ..... 22

**Sarot.**  
Hemostatic forceps ..... 121  
Suture forceps ..... 224

**Satinsky**  
Vascular scissors ..... 47

**Satterlee**  
Saws ..... 458

**Sauerbruch**  
Retractors ..... 353  
Sterilization forceps ..... 372

**Schaaf**  
Cilia forceps ..... 103

**Schädel**  
Towel forceps ..... 136

**Schede**  
Bone curettes ..... 136

**Scherbak**  
Vaginal specula ..... 315

**Schink**  
Dermatome ..... 9

**Schmieden**  
Guiding probes ..... 228

**Schmieden-Payr**  
Guiding probes ..... 228

**Schneider-Sauerbruch**  
Raspatories ..... 320

**Schröder**  
Uterine scoops ..... 279-281  
Uterine tenaculum forceps ..... 294

**Schubert**  
Biopsy forceps ..... 291

**Schuknecht**  
Cannulas ..... 198

**Schultze**  
Salpingograph ..... 298

**Schumacher**  
Biopsy forceps ..... 292,293  
Umbilical scissors ..... 58  
Secondary cataract scissors ..... 20

**Sedillot**  
lateral speculum ..... 275  
Raspatories ..... 418  
Secretion spoons ..... 262

**Sellheim**  
Elevating spoon ..... 300

**Seml**  
Bone holding forceps ..... 338  
Bone rongeur forceps ..... 348  
Raspatories ..... 322

**Semken**  
Delicate dissecting forceps ..... 79  
Delicate tissue forceps ..... 91

**Semm**  
Abdominal retractors ..... 190

**Senn-Green**  
Retractors ..... 157

**Senn-Mueller**  
Retractors ..... 156

**Seutin**  
Bone scissors ..... 69

**Siebold**  
Uterine scissors ..... 57

**Silver**  
Dermatome ..... 9

**Simon**  
Fistula hook ..... 285  
Retractors ..... 294  
Uterine scoops ..... 166

**Simpson**  
Obstetrical forceps ..... 301

**Simpson-Braun**  
Obstetrical forceps ..... 301

**Sims**  
Gynecological scissors ..... 55  
Rectal specula ..... 246,250  
Vaginal specula sets ..... 267

**Sims-Maier**  
Dressing forceps ..... 139

**Singley-Tuttle**  
Intestinal and lung forceps ..... 99

**Smillie**  
Meniscectomy knives ..... 334

**Smith-Buie**  
Anal retractor ..... 251

**Smith (Mod. USA)**  
Bandage scissors ..... 67

**Smith-Petersen**  
Bone rongeur forceps ..... 308  
Gouges ..... 308  
Osteotomes ..... 308

**Somer**  
Uterine elevating forceps ..... 284

**Spencer**  
Ligature scissors ..... 54

**Spencer-Wells**  
Ligature forceps ..... 132

**Spratt**  
Bone curettes ..... 314

**Stacke**  
Ear probes ..... 202

**Standard**  
Dissecting forceps ..... 78, 84

**Standard Adson**  
Delicate tissue forceps ..... 90

**Steinmann**  
Tendon grasping forceps ..... 369

**Stellbrink**  
Bone rongeur forceps ..... 342

**Stevens**  
Tenotomy scissors ..... 27

**Stieglitz**  
Splinter forceps ..... 102

**Stille**  
Bone rongeur forceps ..... 347  
Chisels ..... 311  
Dissecting forceps ..... 84  
Drills ..... 356  
Gouges ..... 311  
Osteotomes ..... 311  
Plaster shears ..... 234

**Stille-Liston**  
Bone cutting forceps ..... 456

**Stille-Luer**  
Bone rongeur forceps ..... 452

**Stille-Ruskin**  
Bone rongeur forceps ..... 453

**Stockmann**  
Penis clamps ..... 262

**Strandell-Stille**  
Tendon sheath hooks ..... 369

**Stratte**  
Suture forceps ..... 223

**Strully**  
Vascular Scissors ..... 49

**Sullivan**  
Gum scissors ..... 62

## T

**Taylor**  
Delicate dissecting forceps ..... 81  
Delicate tissue forceps ..... 93, 94  
Meniscectomy knives ..... 334  
Spinal retractor ..... 334

**Teale**  
Uterine tenaculum forceps ..... 282

**Thomas**  
Uterine curettes ..... 291

**Thomas-Gaylor**  
Biopsy forceps ..... 238

**Thoms-Allis**  
Intestinal and tissue grasping forceps ..... 310

**Tohoku**  
Towel forceps ..... 137

**Tönnis**  
Tonsil scissors ..... 51

**Tönnis-Adson**  
Tonsil scissors ..... 51

**Tönnis-Adson Fino**  
Tonsil scissors ..... 51

**Travers**  
Self-retaining retractors ..... 179

**Trélat**  
Vaginal specula ..... 265

**Troeltsch**  
Ear dressing forceps ..... 88

**Troeltsch (Wilde)**  
Ear dressing forceps ..... 88

**Troutman-Chris**  
Razor blade breaker ..... 6

**Tübinger Modell**  
Self-retaining retractors ..... 176

**Tuffier**  
Spatulas ..... 172  
Tussue grasping forceps ..... 118

## U

**Uffenrode**  
Bone curettes ..... 315



- Ulrich**  
Dressing forceps ..... 139
- Universal**  
Sterilization forceps ..... 372  
Trocar set ..... 196
- V**
- Vaginal forceps ..... 290
- Valleix**  
Uterine probes ..... 278
- Van Burren**  
Urethral bougies ..... 261
- Van Doren**  
Biopsy forceps ..... 292
- Vannas**  
Micro spring scissors ..... 13, 17
- Verbrugge**  
Bone holding forceps ..... 338
- Verbrugge-Müller**  
Bone levers ..... 329
- Virchow**  
Autopsy knives ..... 8
- Vise**  
Micro jewelers forceps ..... 72
- Volkmann**  
Bone curettes ..... 315-316  
Bone retractors ..... 323
- W**
- Wagensteen**  
Suture forceps ..... 215, 223
- Wagner**  
Delicate surgical scissors ..... 23
- Waldmann**  
Perineum (Episiotomy) scissors ..... 59
- Walter-Carmalt**  
Splinter forceps ..... 101
- Walton**  
Delicate scissors ..... 19, 22
- Wangensteen**  
Dissecting forceps ..... 85
- Waugh**  
Delicate dissecting forceps ..... 80  
Delicate tissue forceps ..... 92
- Webster**  
Suture forceps ..... 212, 217
- Weitlaner**  
Self-retaining retractors ..... 175, 180
- Weitlaner-Baby**  
Self-retaining retractors ..... 180
- Weitlaner-Wullstein**  
Self-retaining retractors ..... 175
- Weller**  
Dissecting scissors ..... 38
- Wertheim**  
Gynecological scissors ..... 55  
Hysterectomy forceps ..... 288  
Peritoneal forceps ..... 286
- Wertheim-Cullen**  
Hysterectomy forceps ..... 289
- Westcott**  
Tenotomy scissors ..... 13, 18
- Williger**  
Bone curettes ..... 315, 317  
Elevators ..... 326  
Raspatories ..... 320
- Wilmer**  
Delicate dissecting scissors ..... 27
- Winter**  
Ovum forceps ..... 303
- Wolff**  
Plaster breaker ..... 234
- Wrigley**  
Obstetrical forceps ..... 301
- Wylie**  
Retractors ..... 164
- Y**
- Yankauer-Standard**  
Cannulas ..... 197
- Yasargil**  
Dissecting micro forceps ..... 75  
Micro tumor grasping forceps ..... 76
- Young**  
Prostatic retractor ..... 259  
Urology instruments ..... 259
- Z**
- Zaufal-Jansen**  
Bone rongeur forceps ..... 346



**Ermis**<sup>®</sup>  
MedTech

Nachdruck, auch auszugsweise, verboten.  
Reprinting even partially is not allowed.



# CHIRURGISCHE INSTRUMENTE



Ermis®

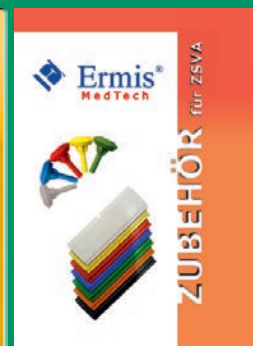

Ermis MedTech GmbH  
Dornierstraße 49  
78532 Tuttlingen  
Tel: +49 (0) 7461/964857-0  
Fax: +49 (0) 7461/964857-99  
info@ermis-medizintechnik.de



[www.ermis-medizintechnik.de](http://www.ermis-medizintechnik.de)